

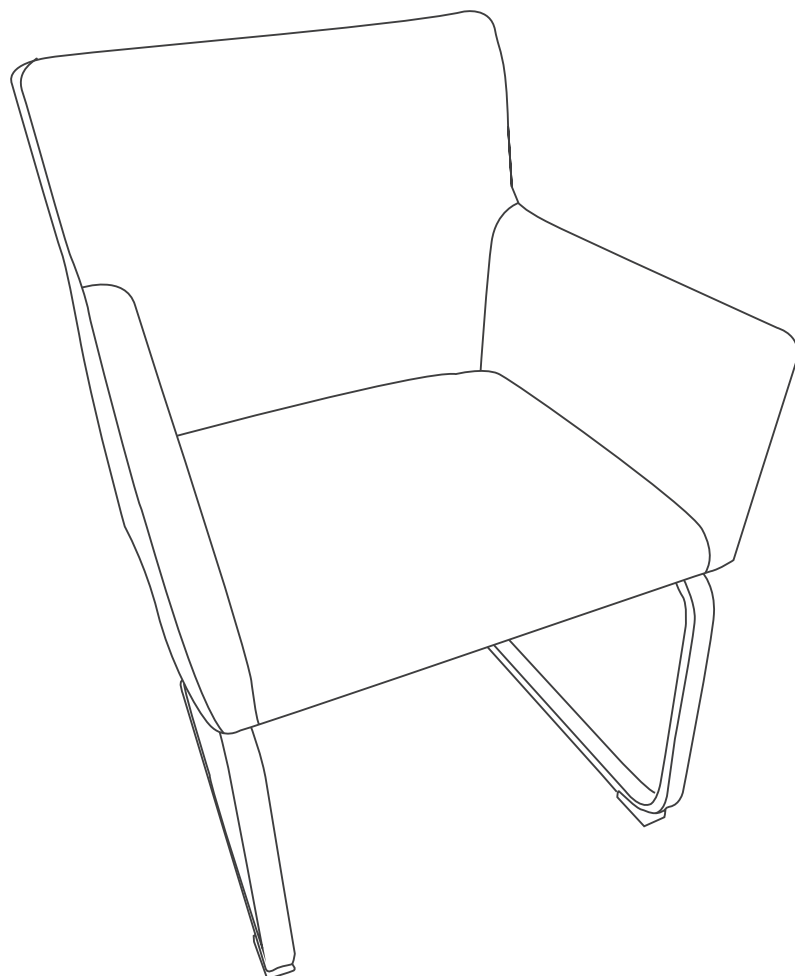





10780030/01/02



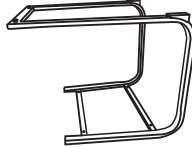

| | | |
|-----------------------------------------------------------------------------------------------------|-----------------------------------------------------------------------------------------------------|-------------------------------------------------------------------------------------------------------|
| ①  x1 | ②  x1 | |
| A  x4 M6X25mm | B  x4 M6X18mm | C  x1 M5X65mm |

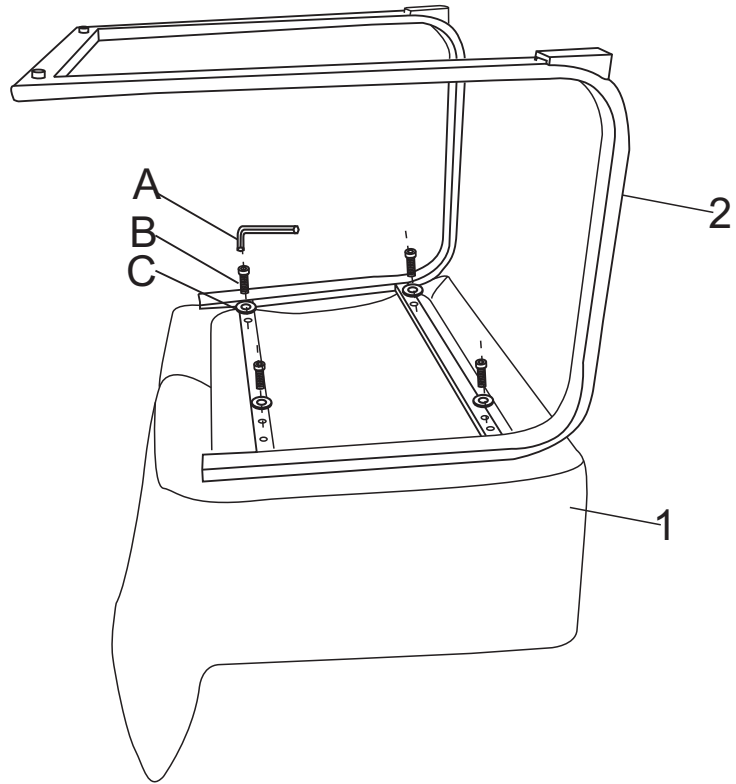

①



| | | |
|---|------------------------------------------------------------------------------------------------|-------|
| A |  M6X25mm | 4 PCS |
| B |  M6X18mm | 4 PCS |
| C |  M5X65mm | 1 PC |

②

