

1803

LINATE LTK06

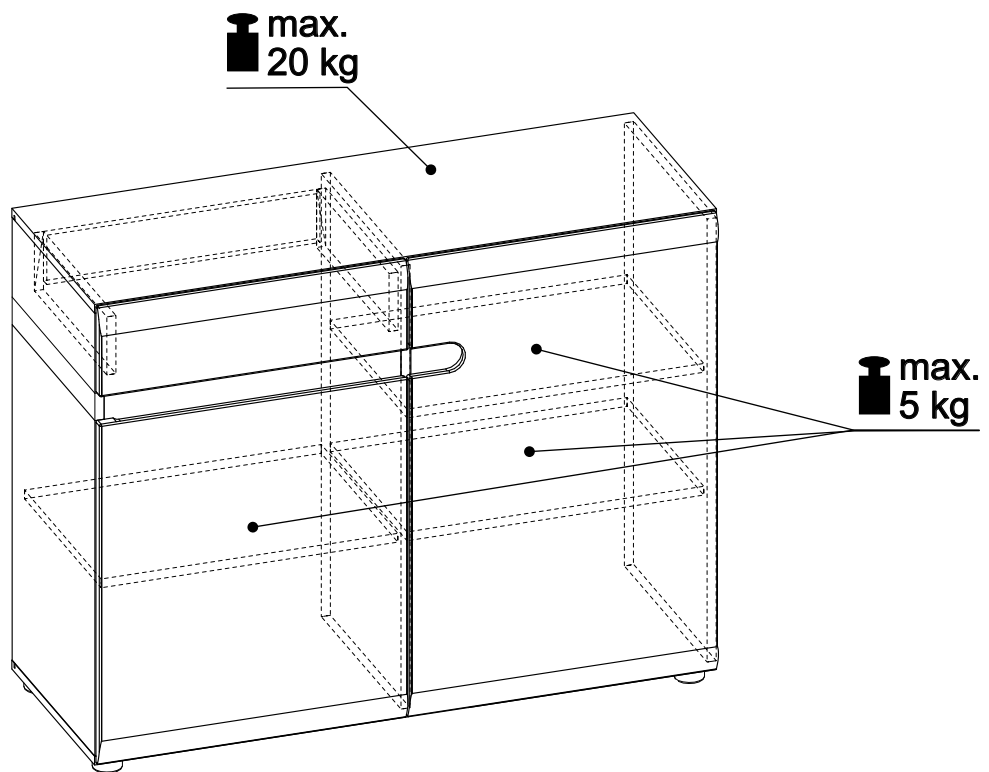

- 90 min.



- | | | |
|--------|--------|--------|
| ① - C2 | ⑧ - C1 | ⑮ - C1 |
| ② - C2 | ⑨ - C1 | ⑯ - C1 |
| ③ - C2 | ⑩ - C1 | ⑰ - C1 |
| ④ - C2 | ⑪ - C1 | |
| ⑤ - C1 | ⑫ - C1 | |
| ⑥ - C1 | ⑬ - C1 | |
| ⑦ - C2 | ⑭ - C1 | |



LINATE LTK06

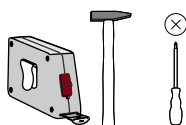
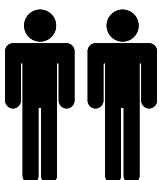
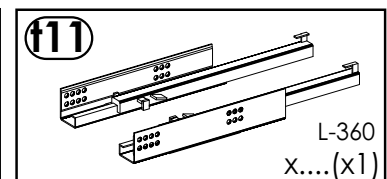
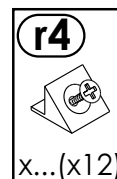
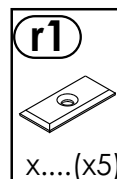
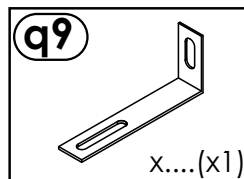
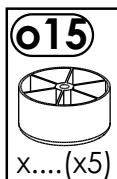
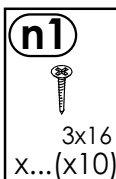
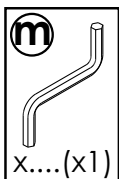
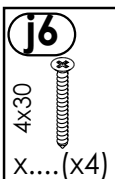
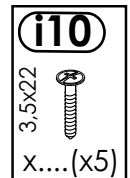
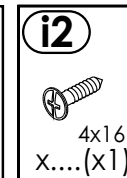
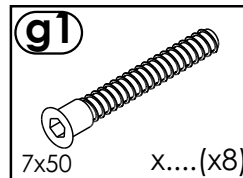
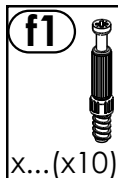
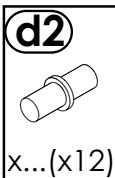
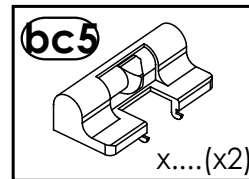
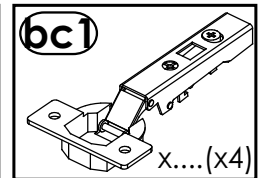
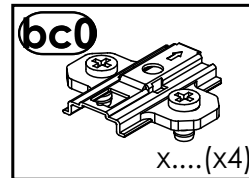
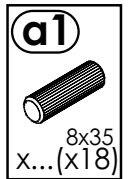
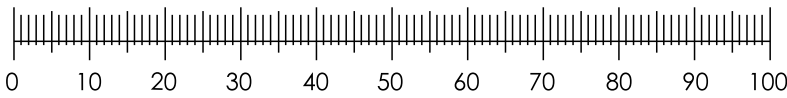
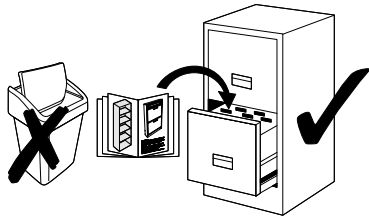
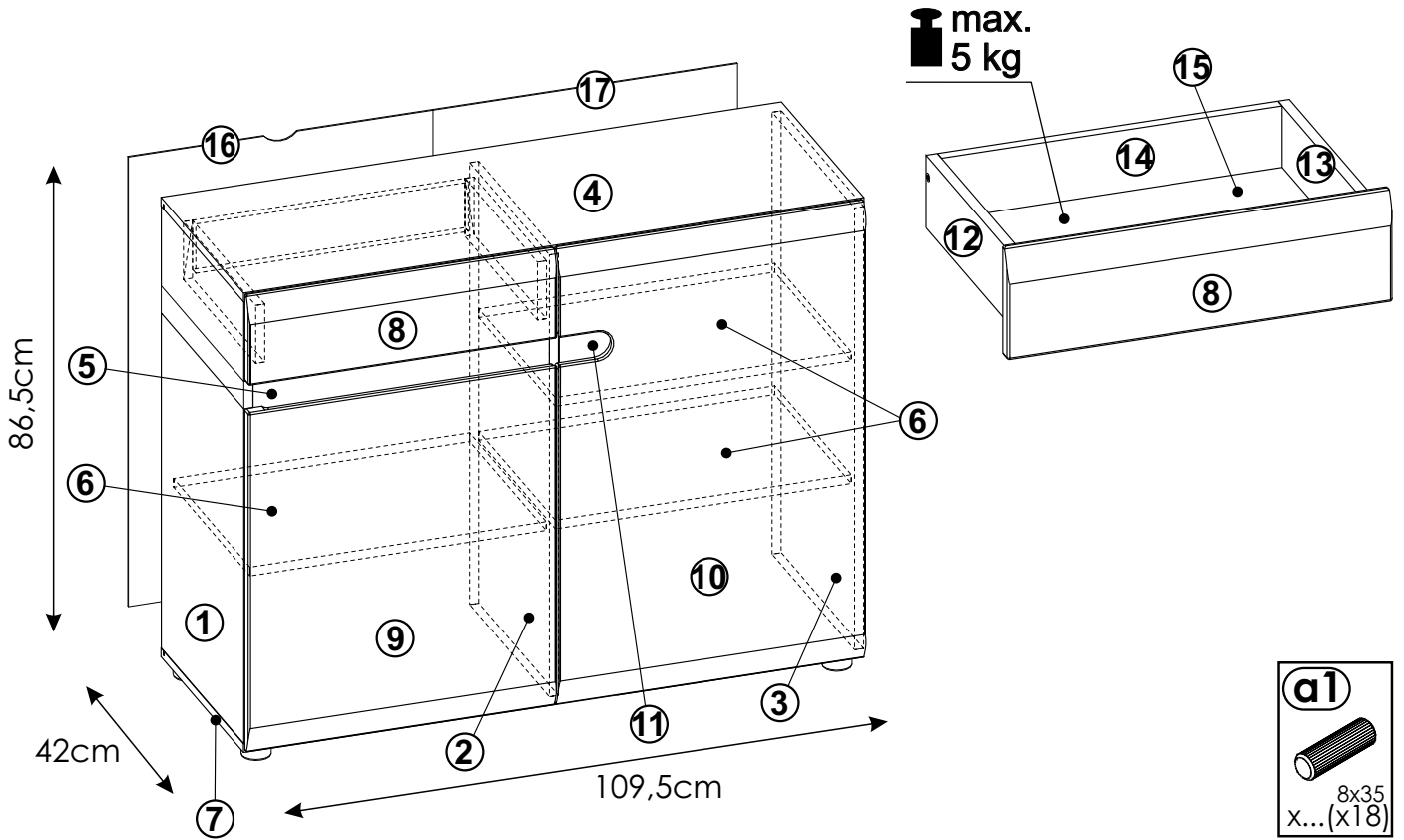

1

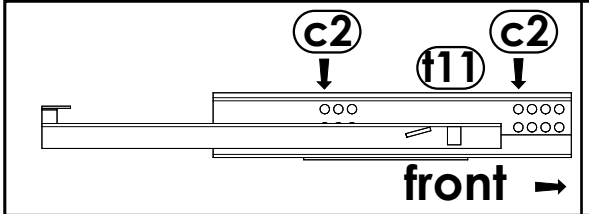
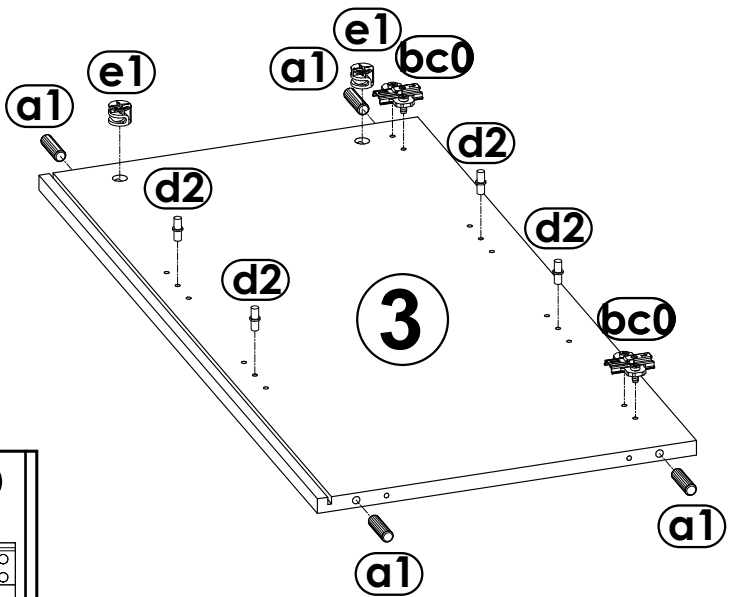
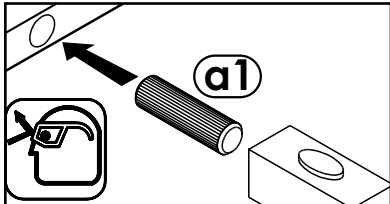
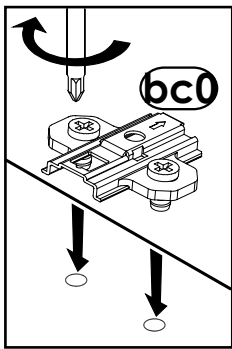
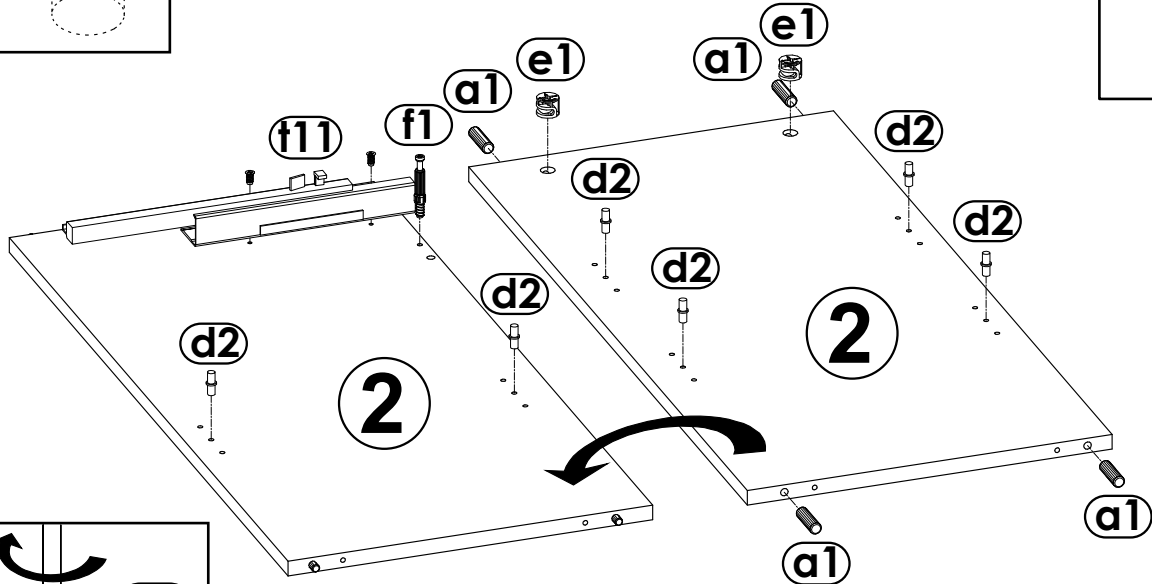
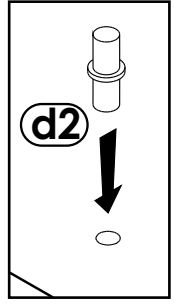
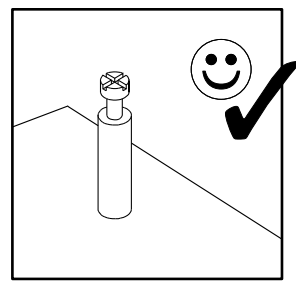
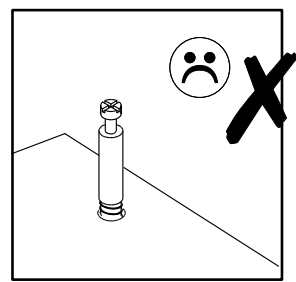
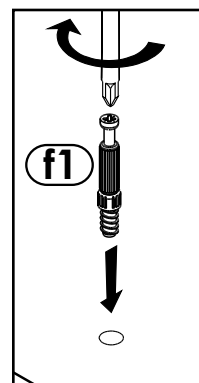
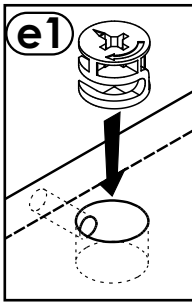
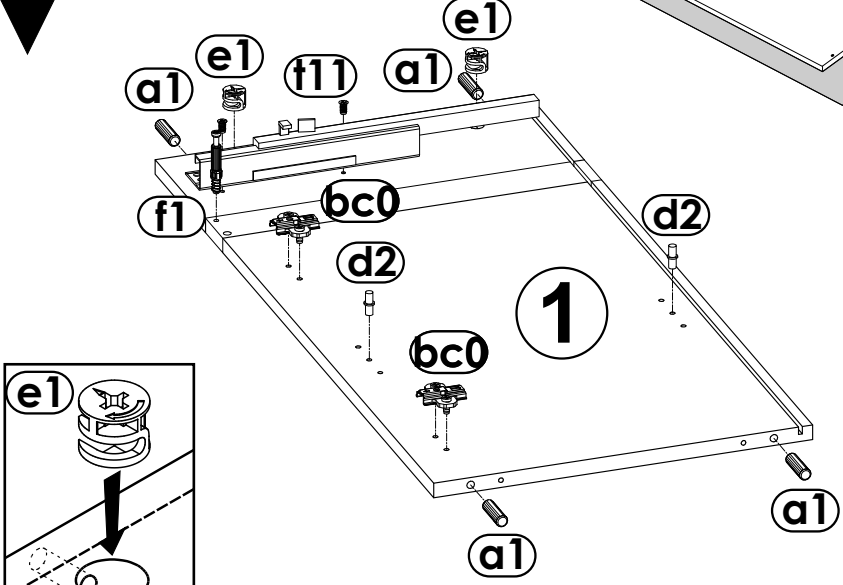
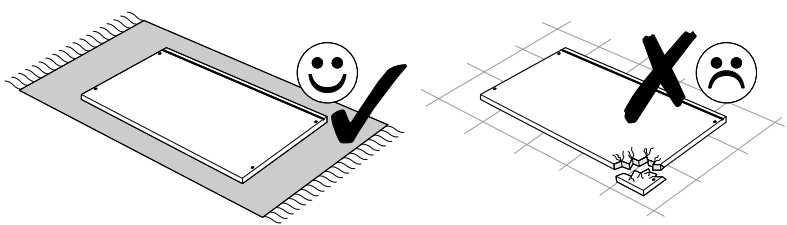

2

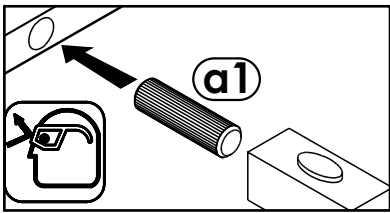
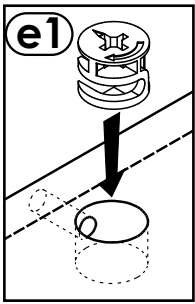
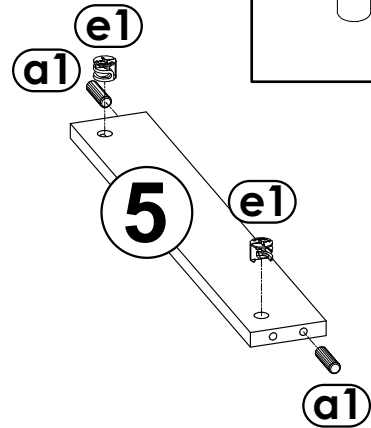
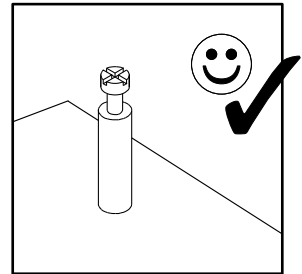
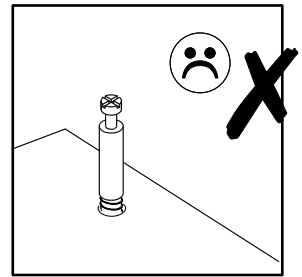
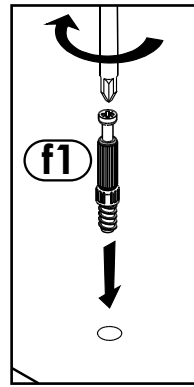
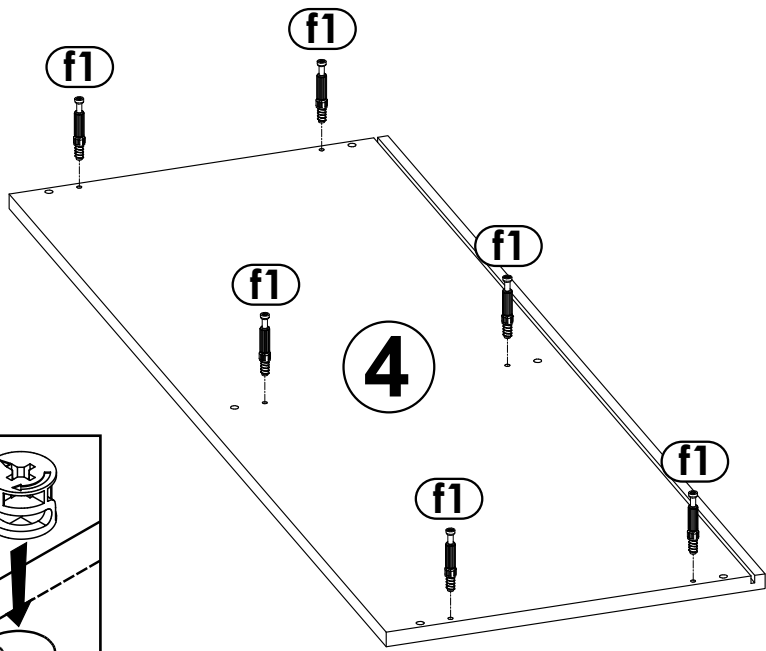
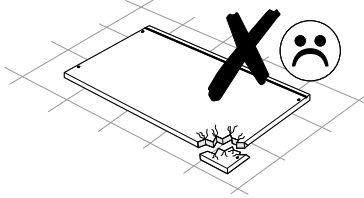
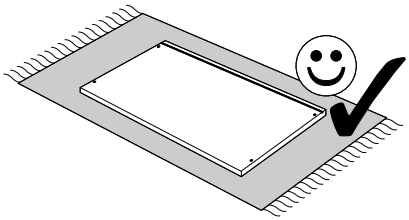

3

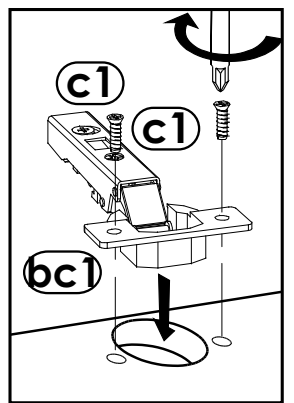
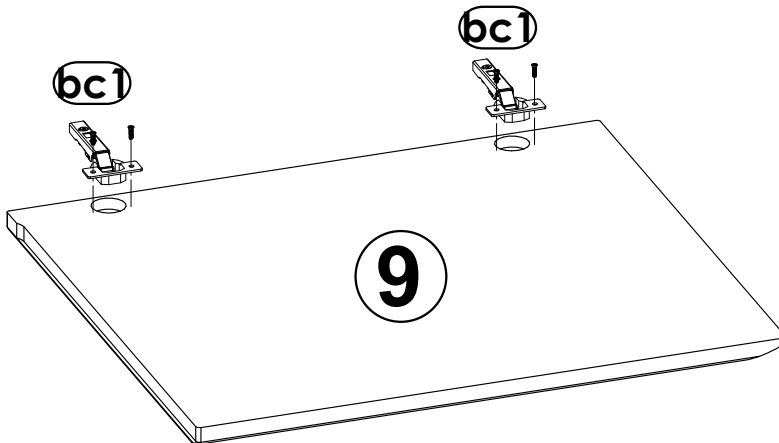
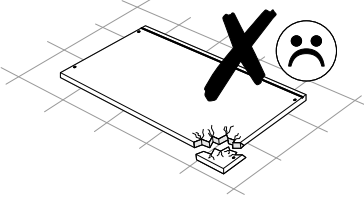
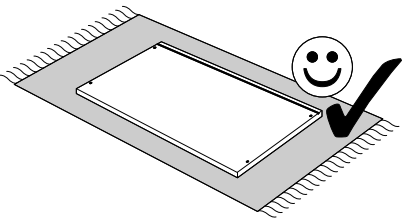

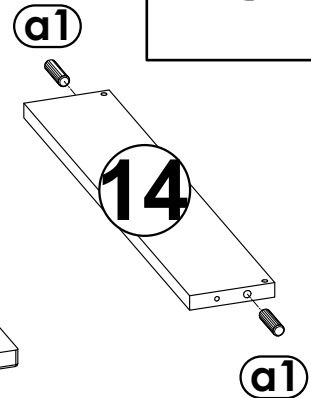
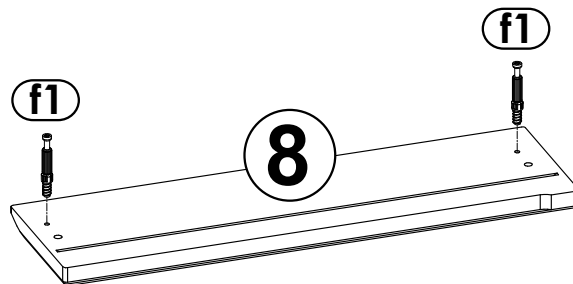
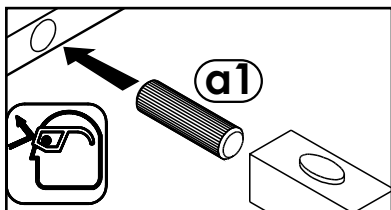
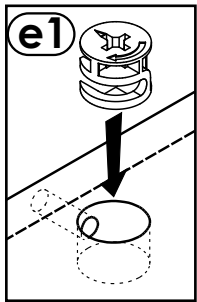
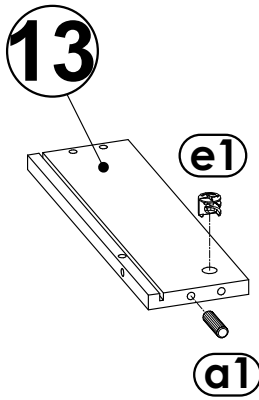
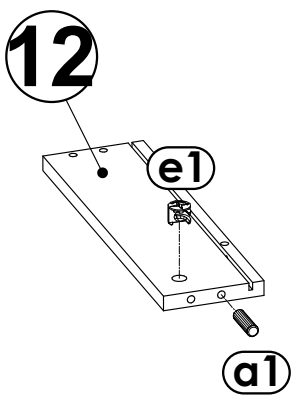
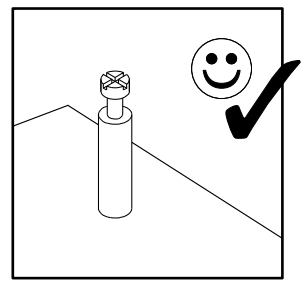
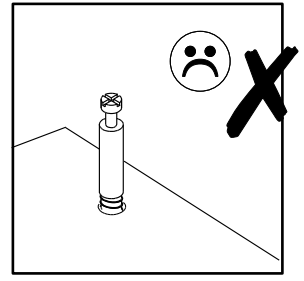
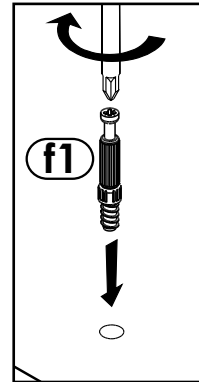
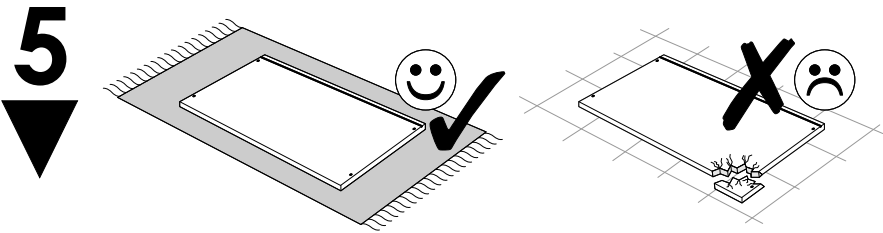
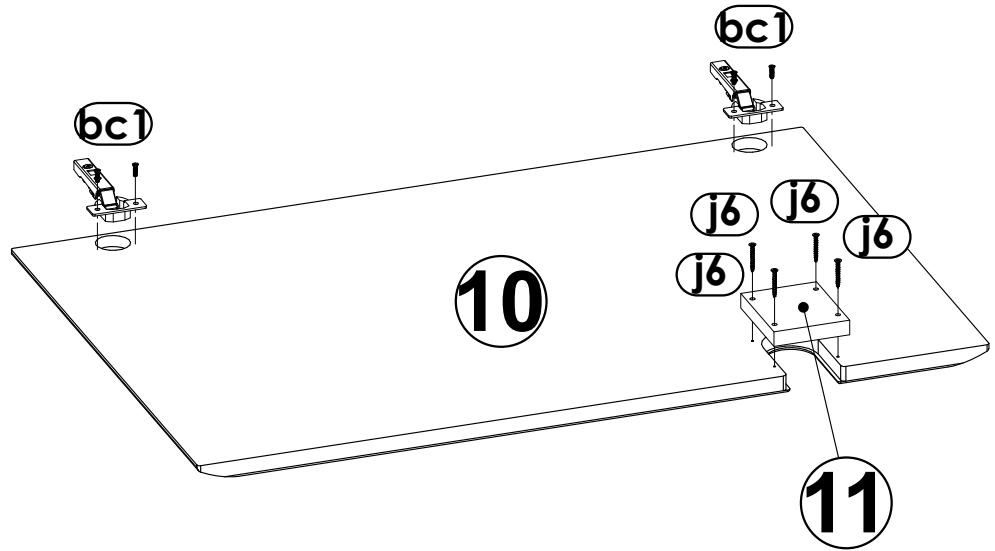
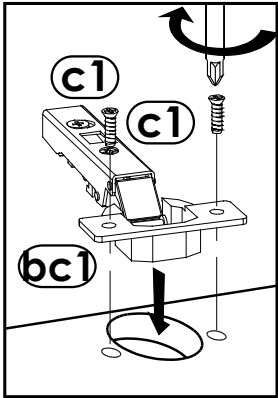
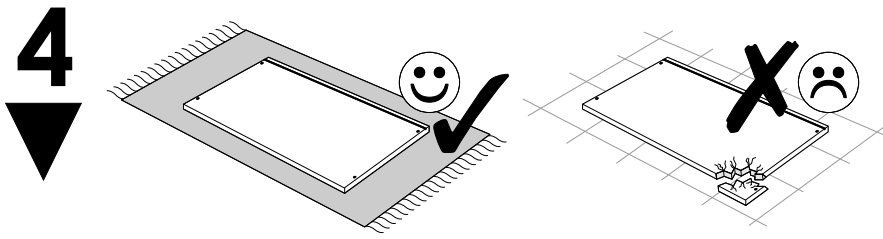

6

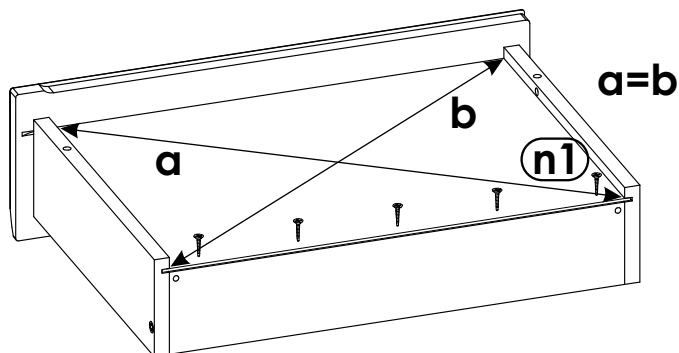
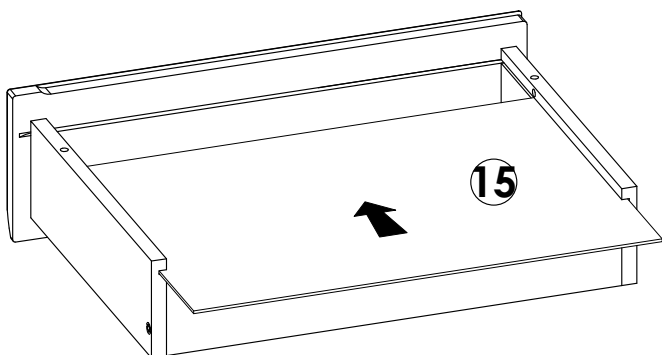
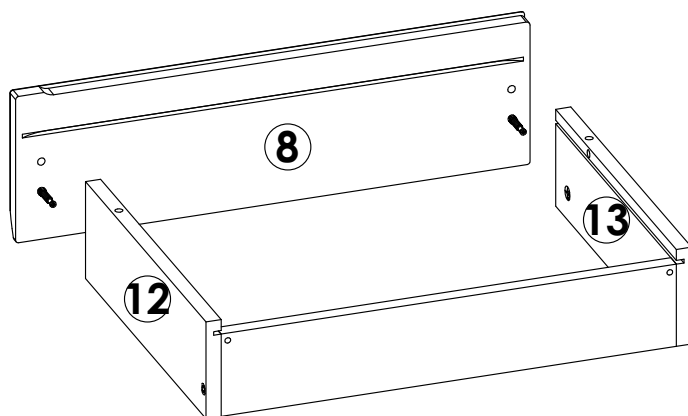
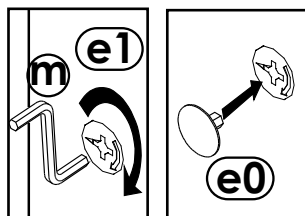
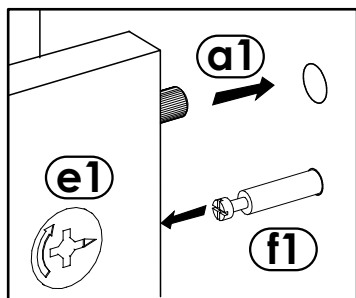
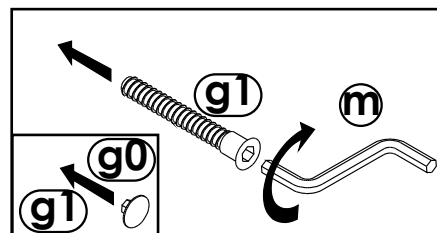
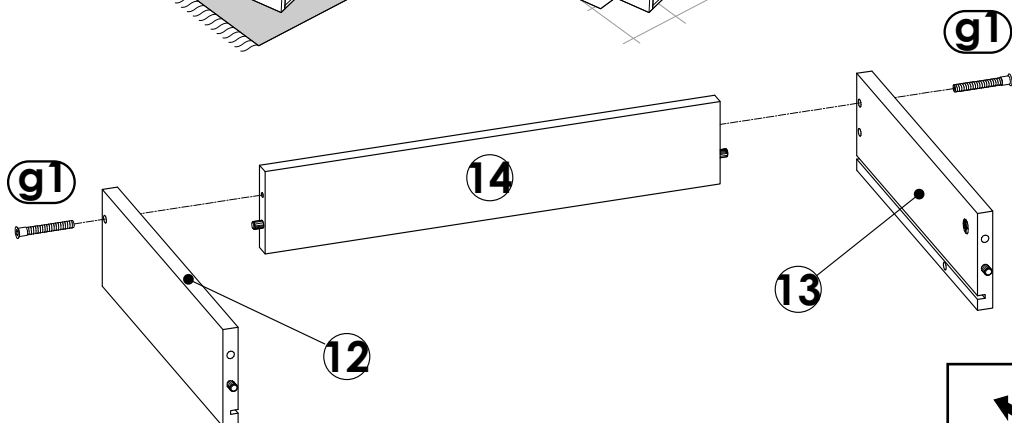
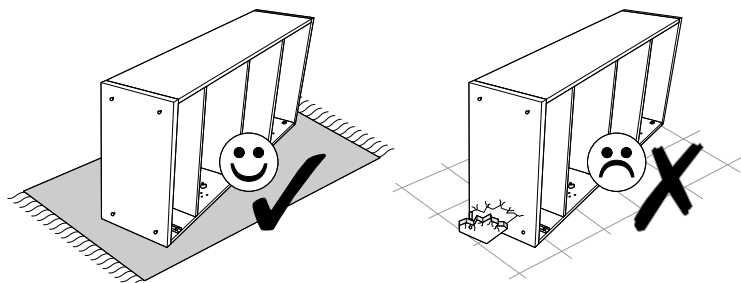

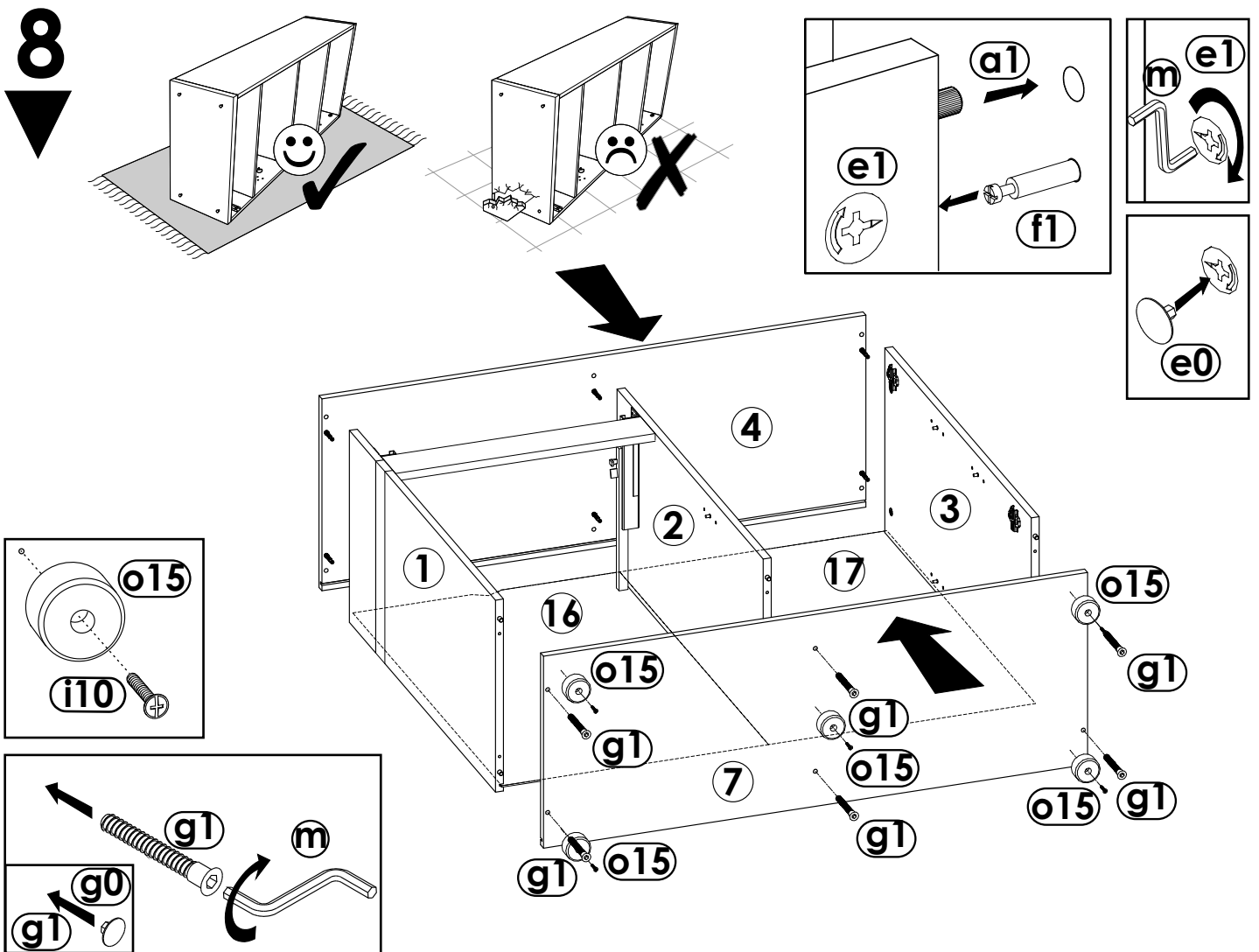
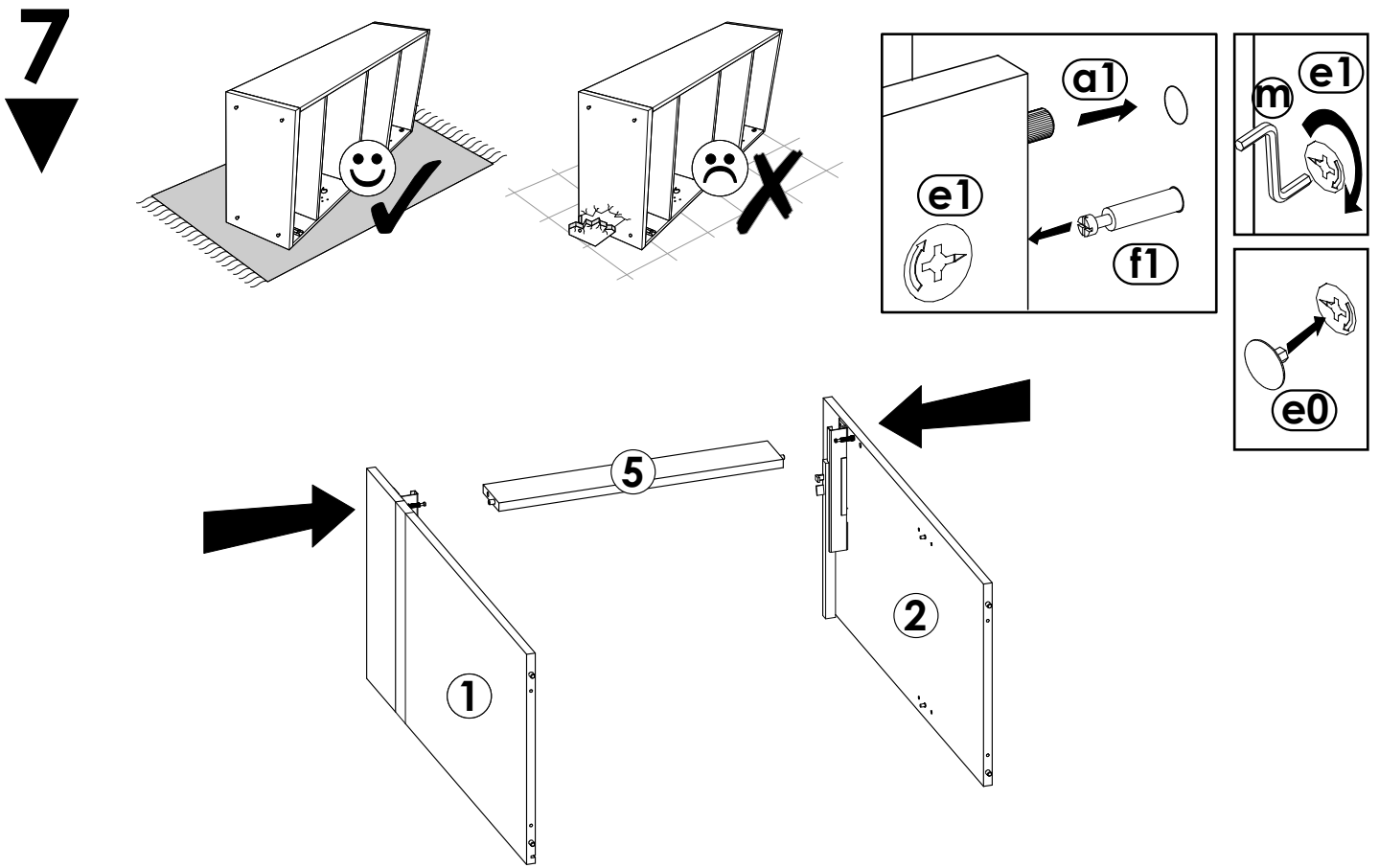

9
▼

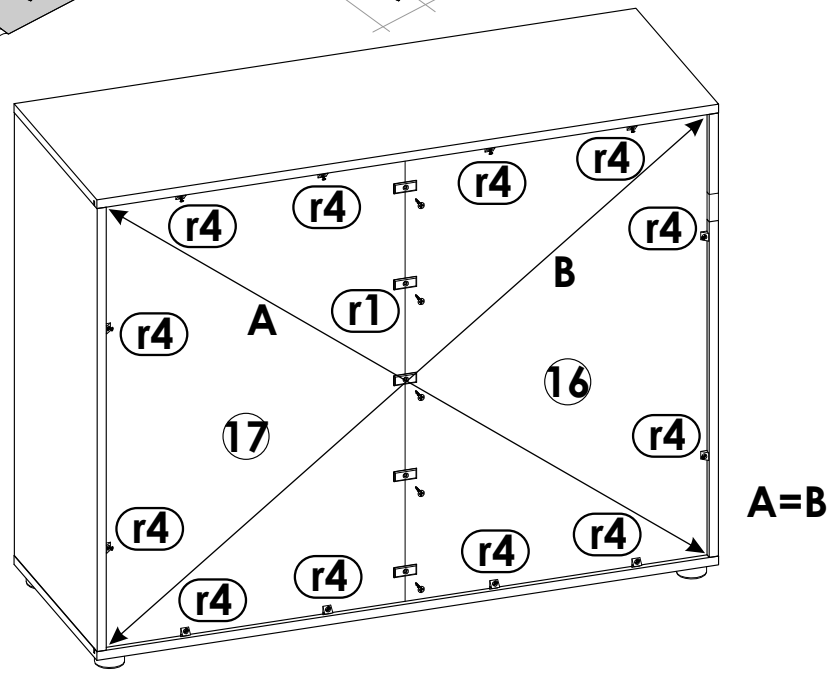
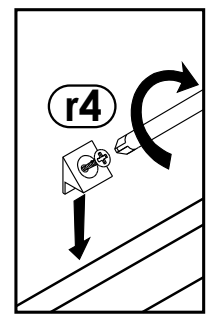
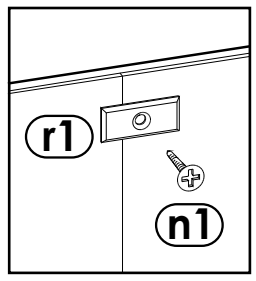
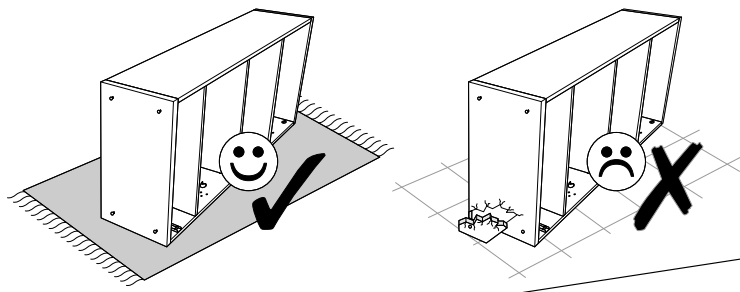

10
▼

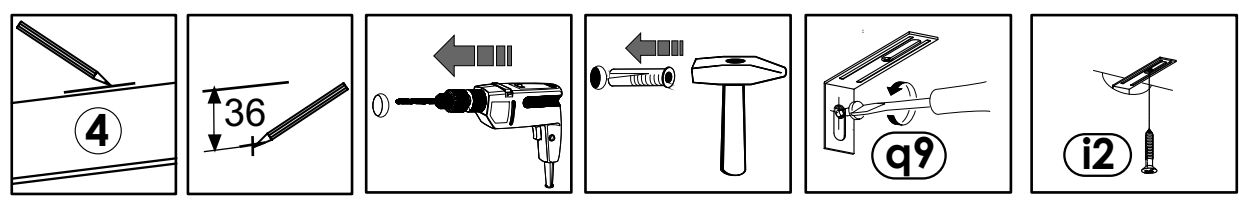
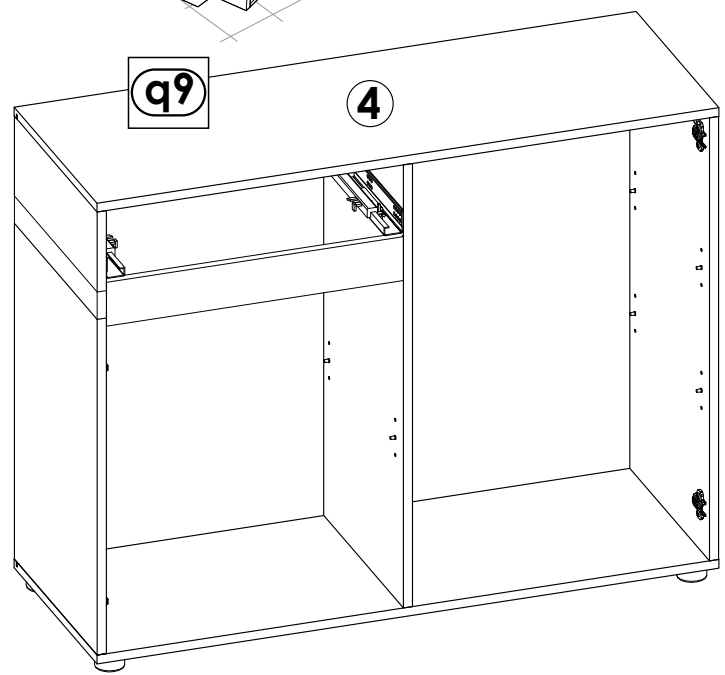
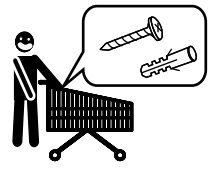
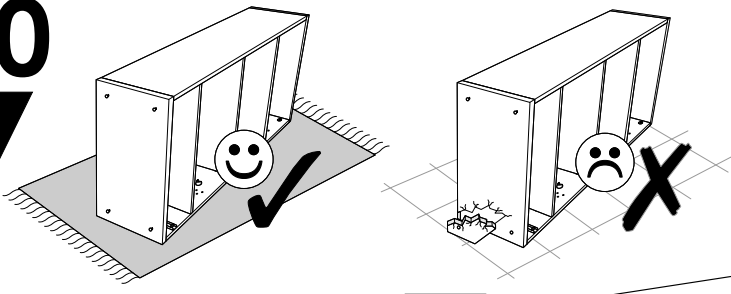

11
▼

