

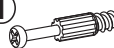















Beschläge Colli 3-3

- B1**  ϕ 8x28 x12
- T1**  x12
- M1**  x12
- C2**  ϕ 20 x12
- C2**  ϕ 20 x4
- W1**  x4
- J23**  x10
- G4**  x6
- P2**  3x16 x10
- S11**  4x25 x4

- Y0**  KR0 x5
- S8**  4x13 x10

- F10**  x4
- P17**  4x20 x4

- U90**  x1
- P5**  4x30 x2

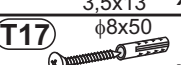
- J11**  x1
- P13**  3,5x13 x2
- T17**  ϕ 8x50
5x60 x1

Nr	Ausmaß			St
1	360	284	4	1
2	1098	309	15	1
3	1098	309	15	1
4	1108	200	15	1
5	658	316	15	1
6	150	316	15	1
7	568	273	15	1
8	568	265	15	1
9	1092	124	15	1
10	600	310	15	1
11	600	330	15	1
12	1112	291	2	1
13	1112	291	2	1

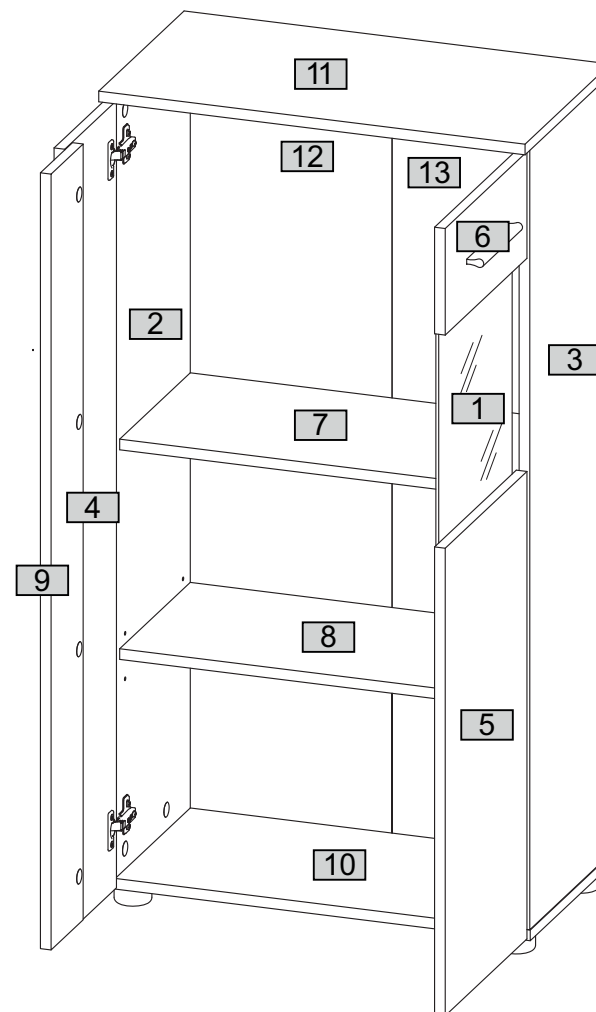

0 10 20 30 40 50 60 70 80 90 100 110 120 130 140 150 160 170 180 190 200

1

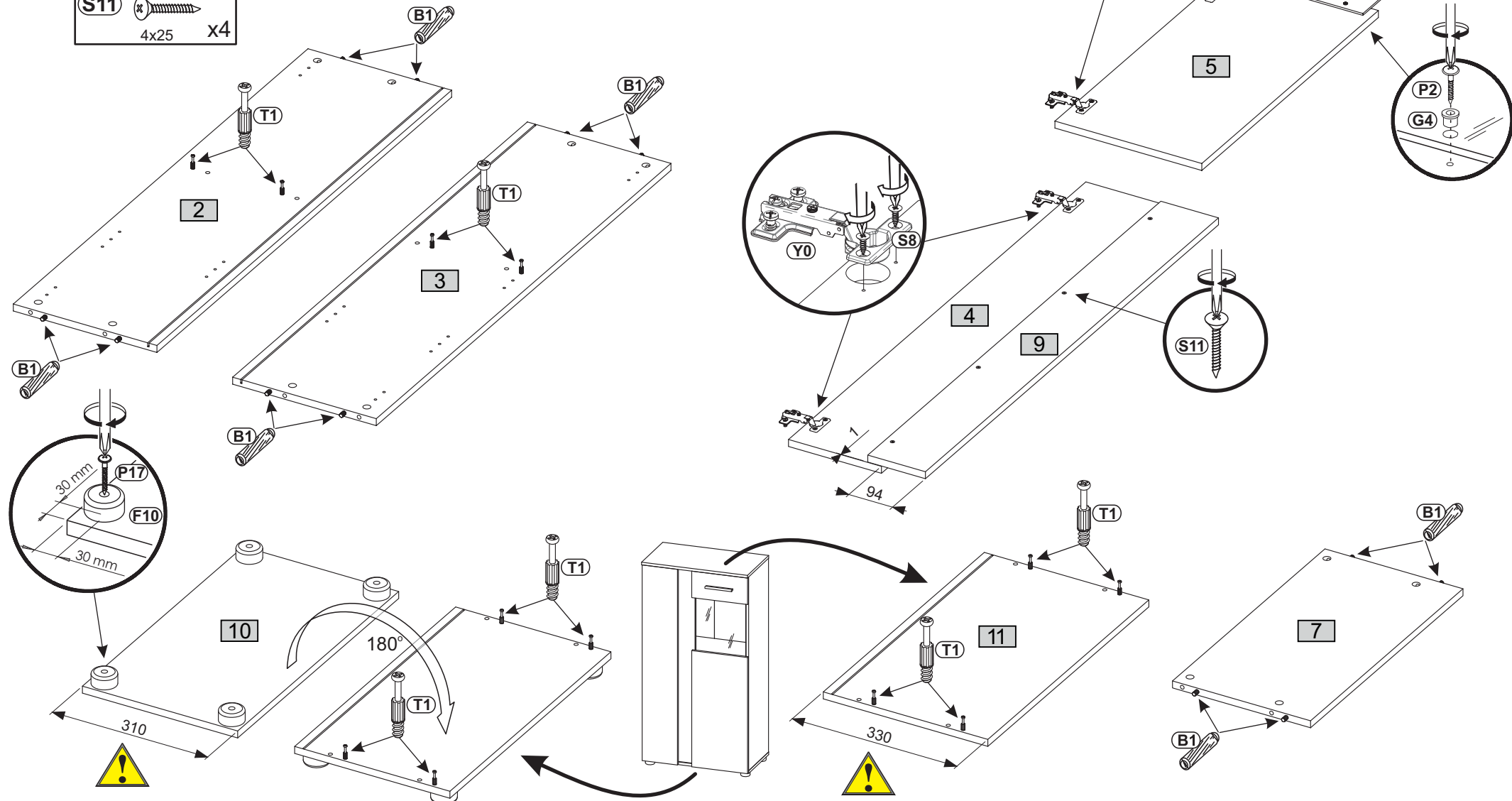
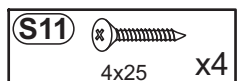
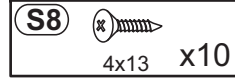
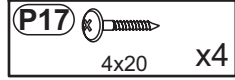
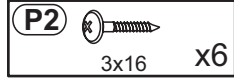
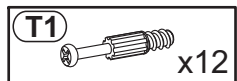
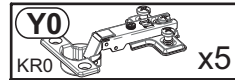
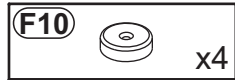
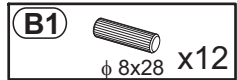

2

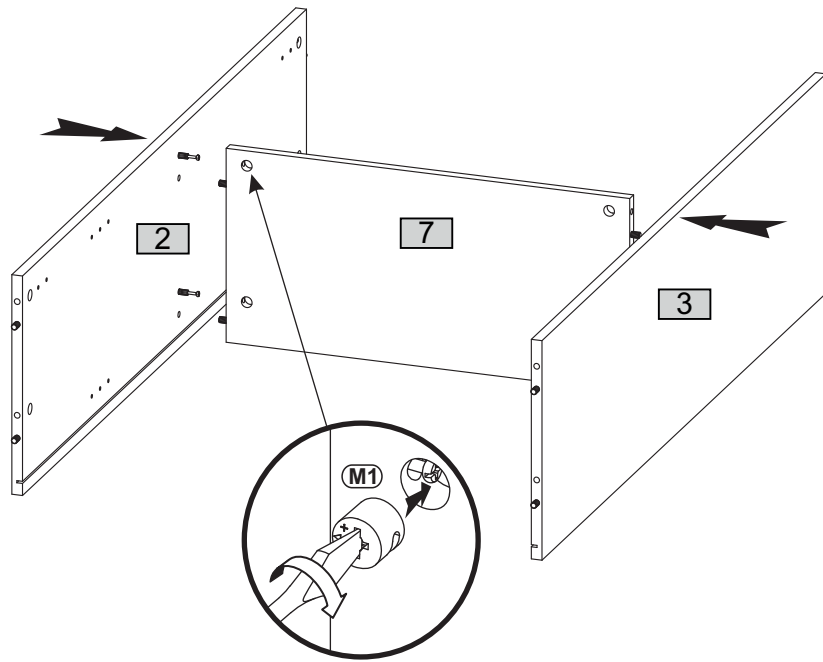

3

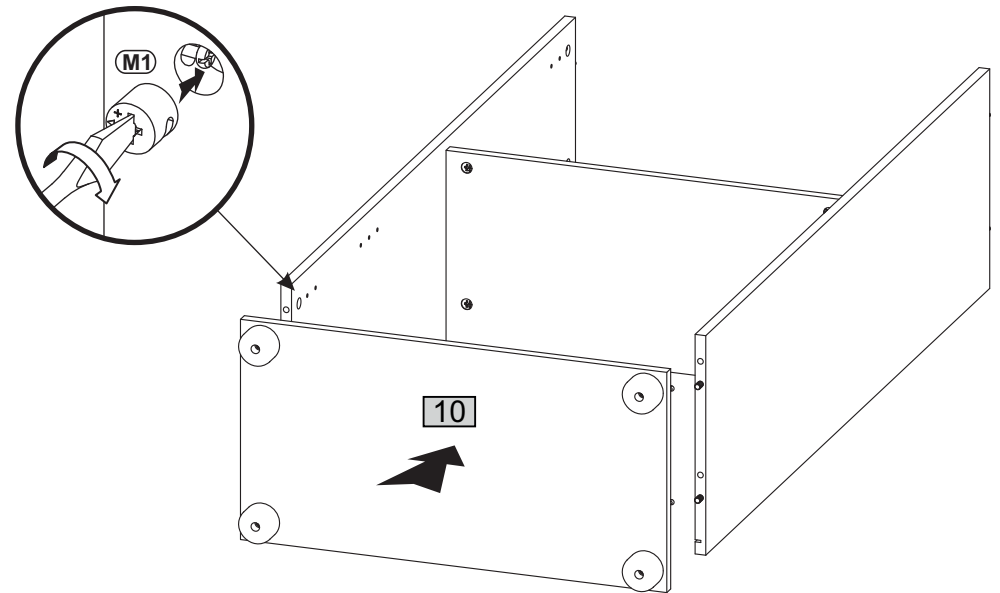

4

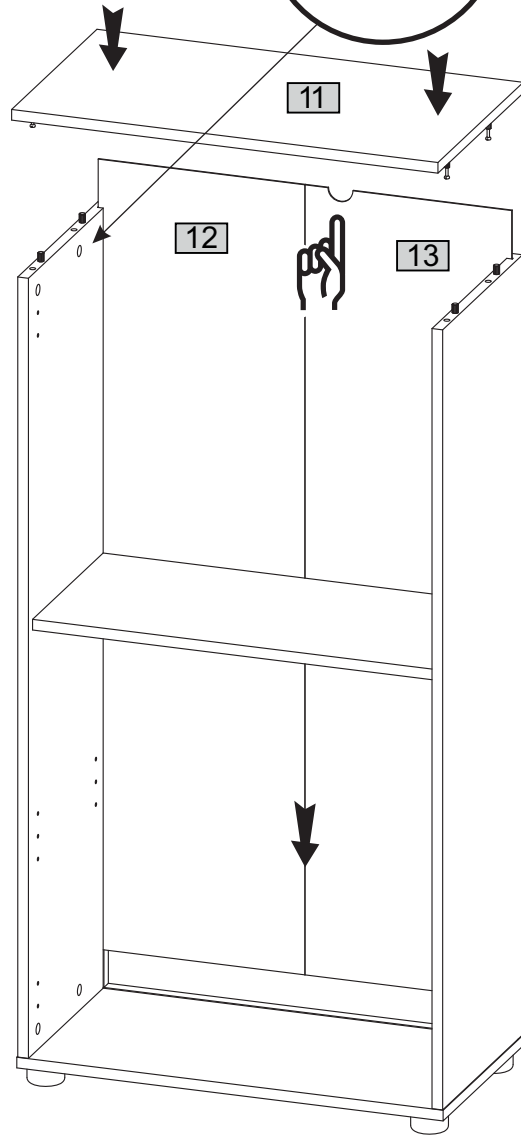
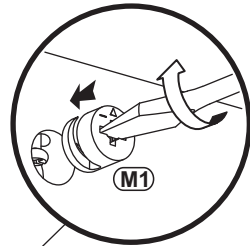

5

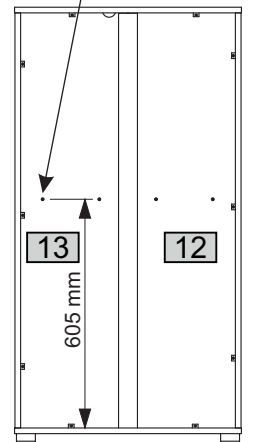
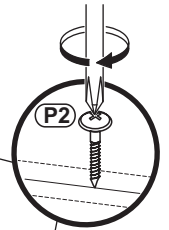
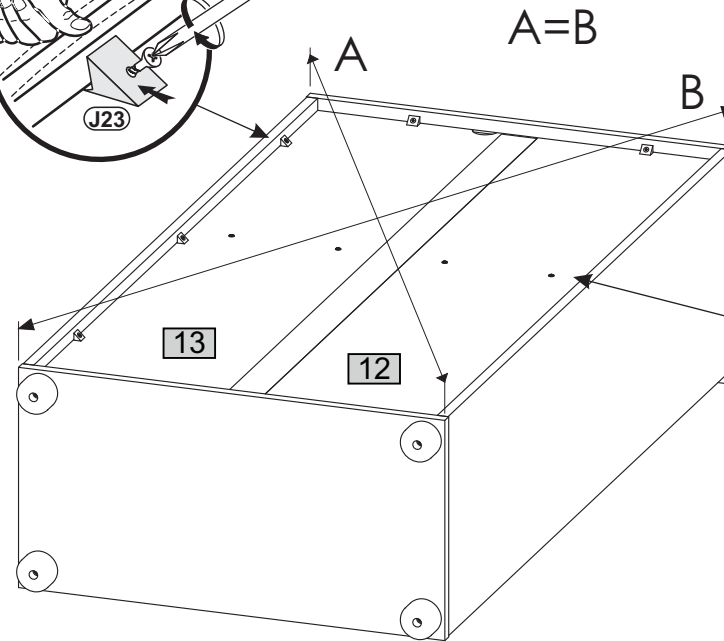
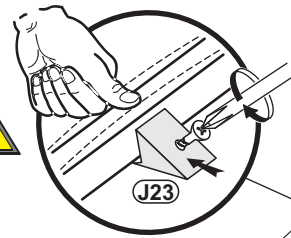
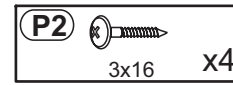
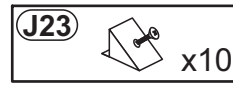

6

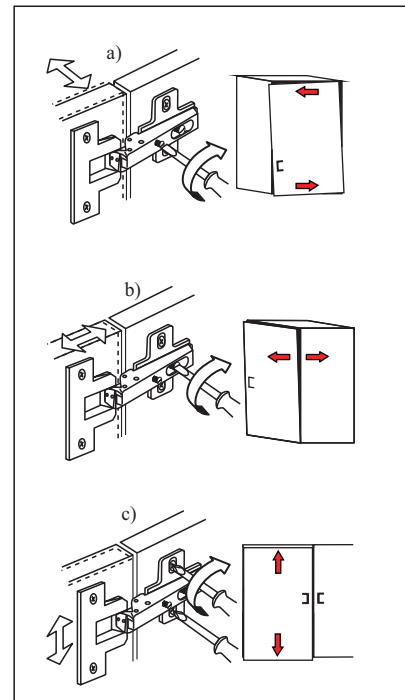
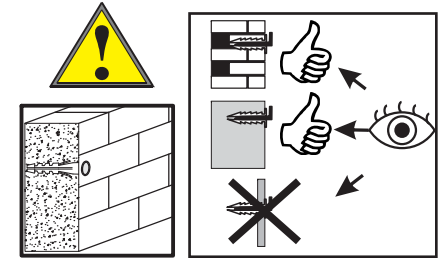
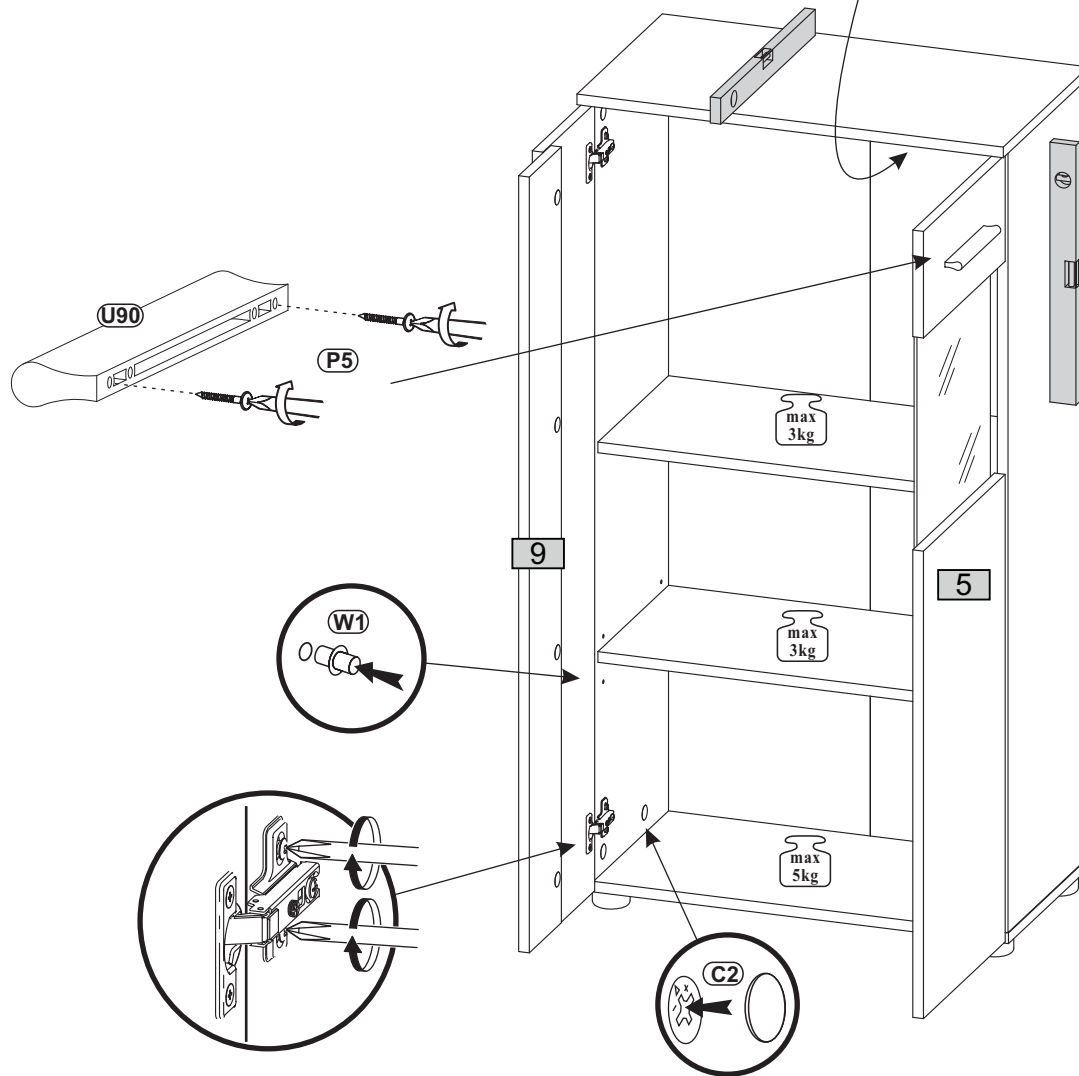
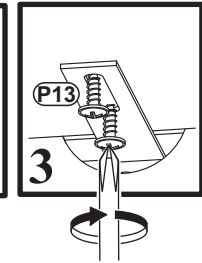
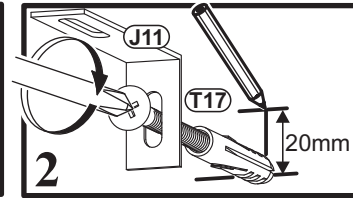
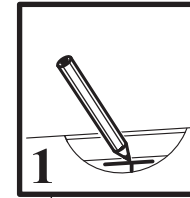
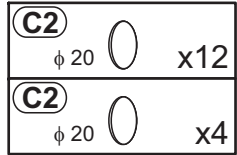
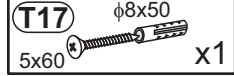
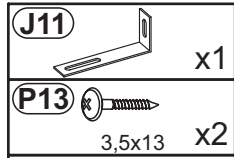
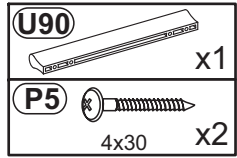

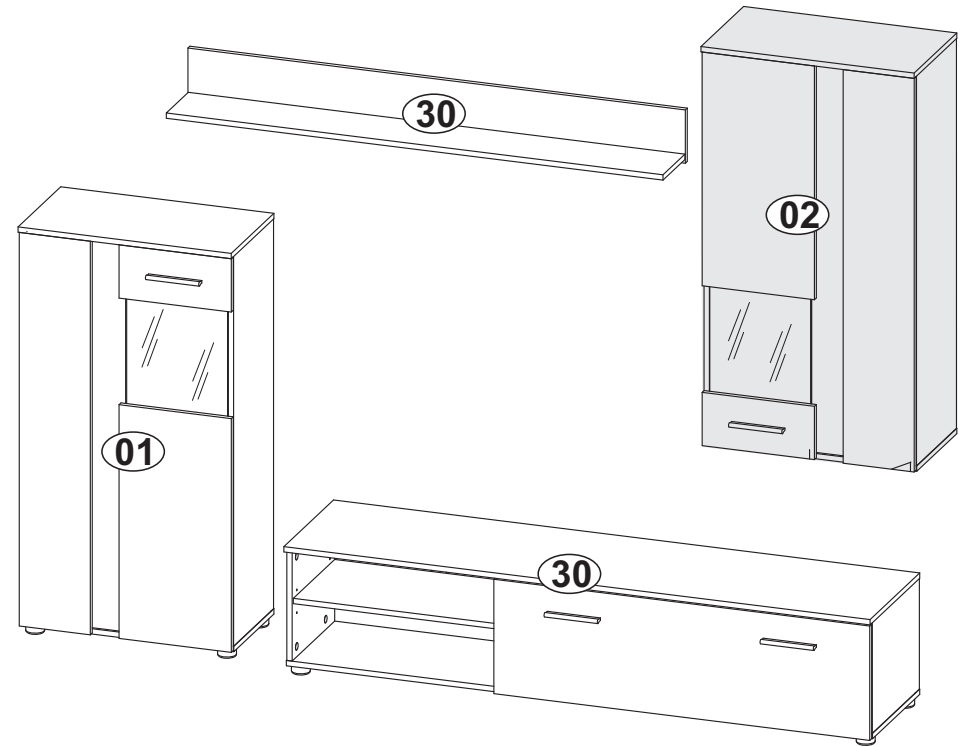
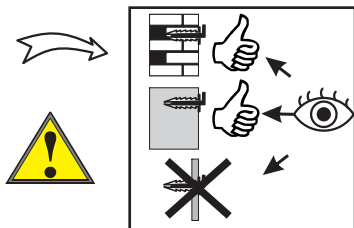
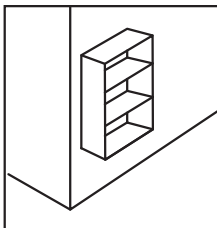
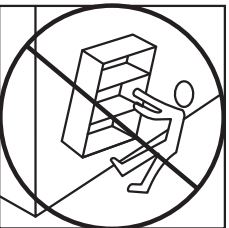
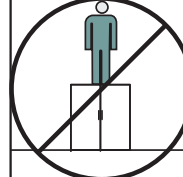
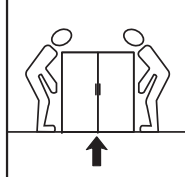
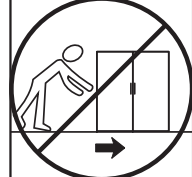
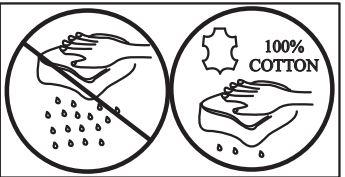
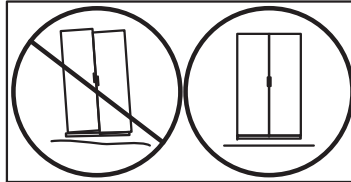
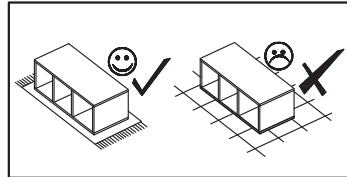
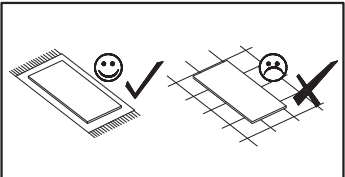
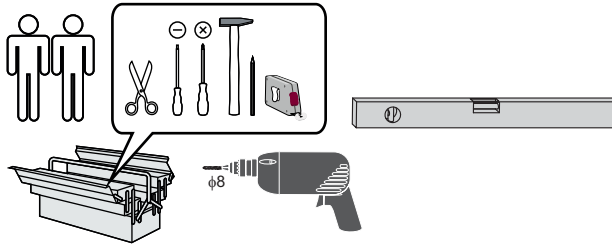
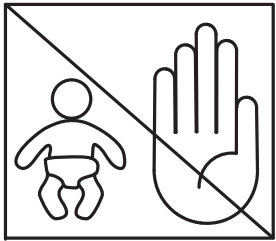

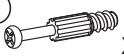

Beschläge Colli 3-3

B1  ϕ 8x28 x12

T1  x12

M1  x12

C2  ϕ 20 x12

C2  ϕ 20 x4

W1  x4

J23  x10

G4  x6

P2  3x16 x10

S11  4x25 x4

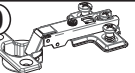
Y0  KR0 x5

S8  4x13 x10

T30  x1

T31  x1

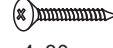
S12  4x30 x4

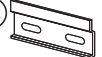
F33  x2

T17 ϕ 8x50
5x60  x4

U90  x1

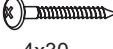
P5  4x30 x2

Nr	Ausmaß		St
1	360	284	4 1
2	1098	309	15 1
3	1098	309	15 1
4	150	316	15 1
5	658	316	15 1
6	1108	200	15 1
7	568	273	15 1
8	568	265	15 1
9	1092	124	15 1
10	600	310	15 1
11	600	330	15 1
12	1112	291	2 1
13	1112	291	2 1

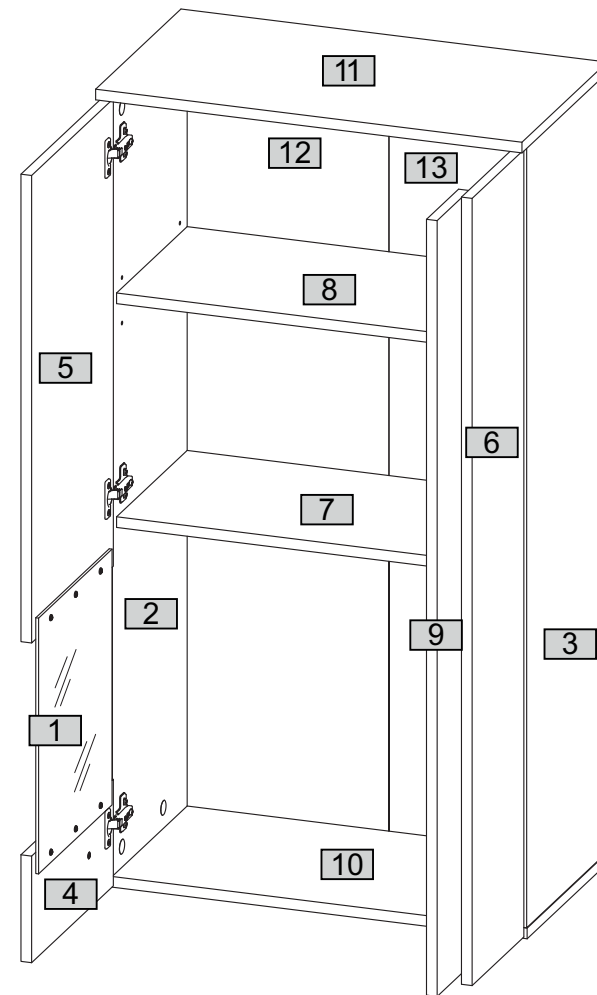

0 10 20 30 40 50 60 70 80 90 100 110 120 130 140 150 160 170 180 190 200



1

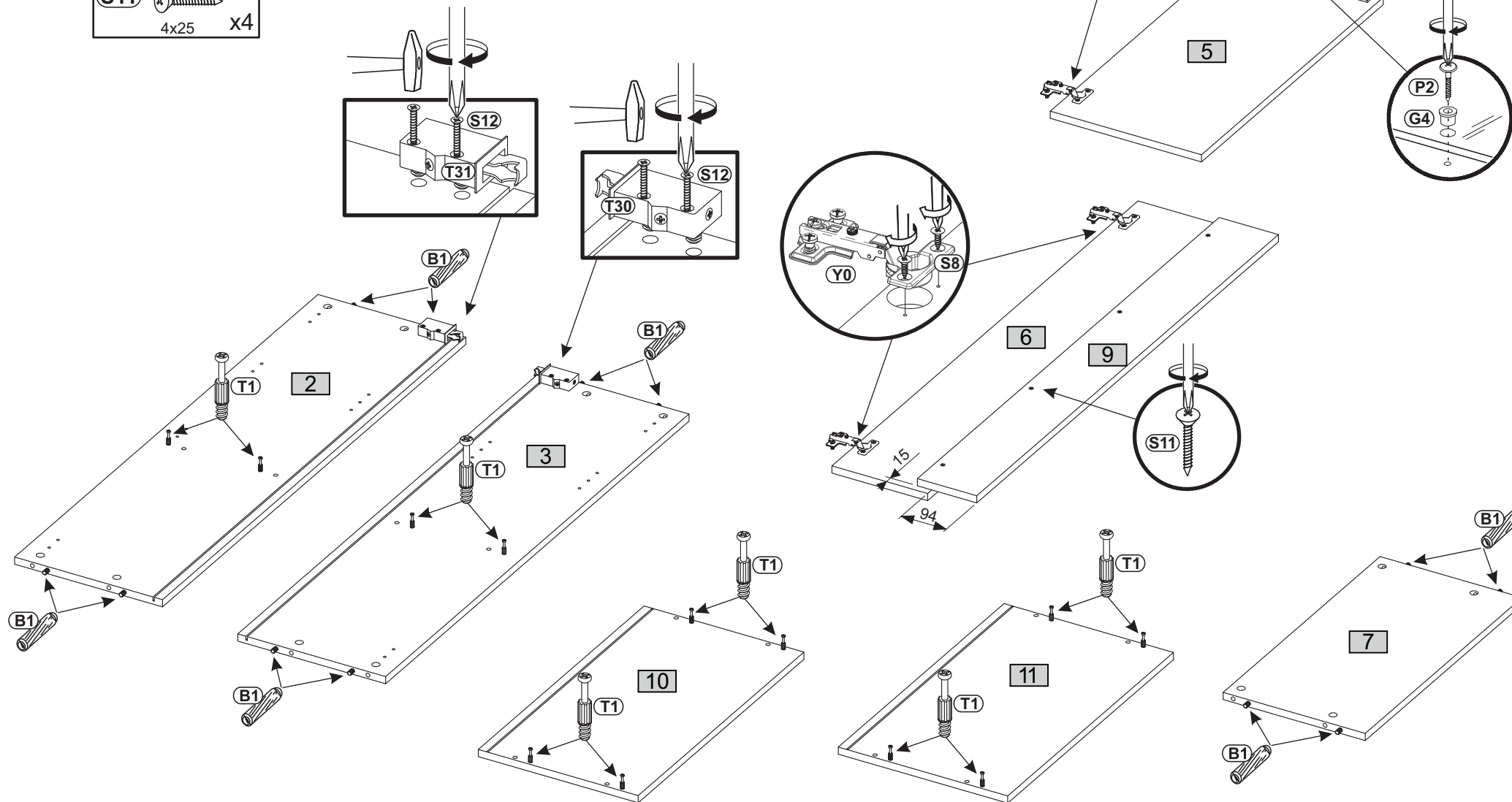
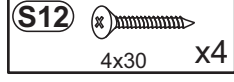
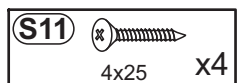
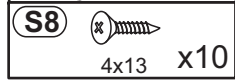
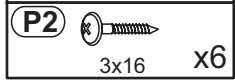
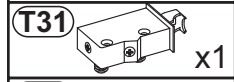
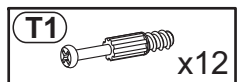
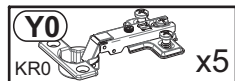
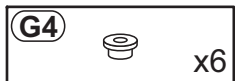
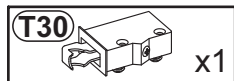
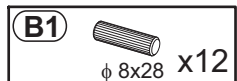

2

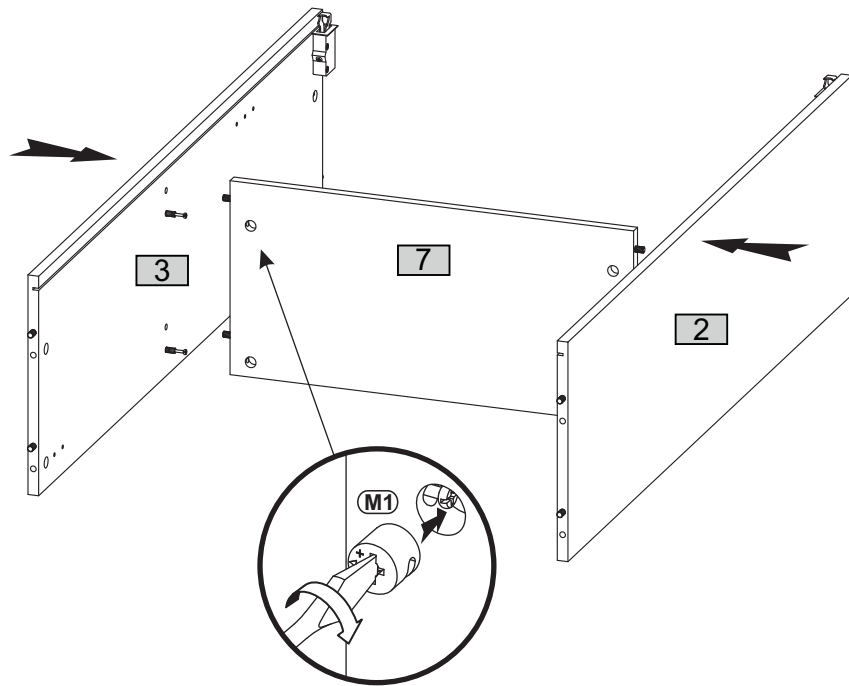

3

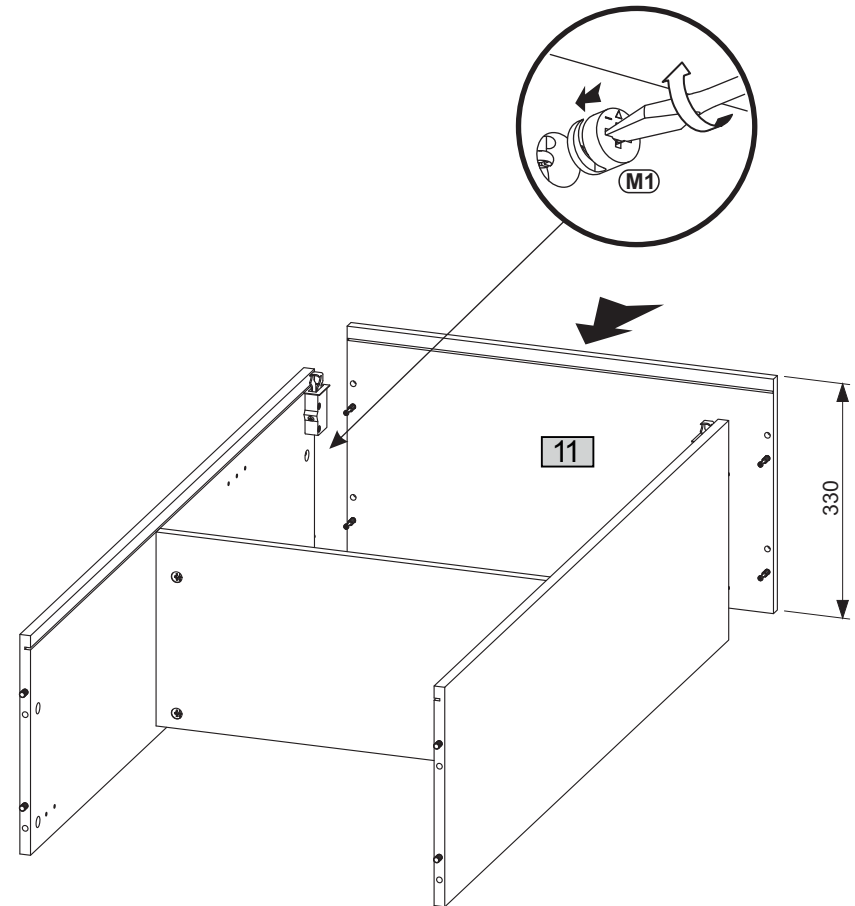

4

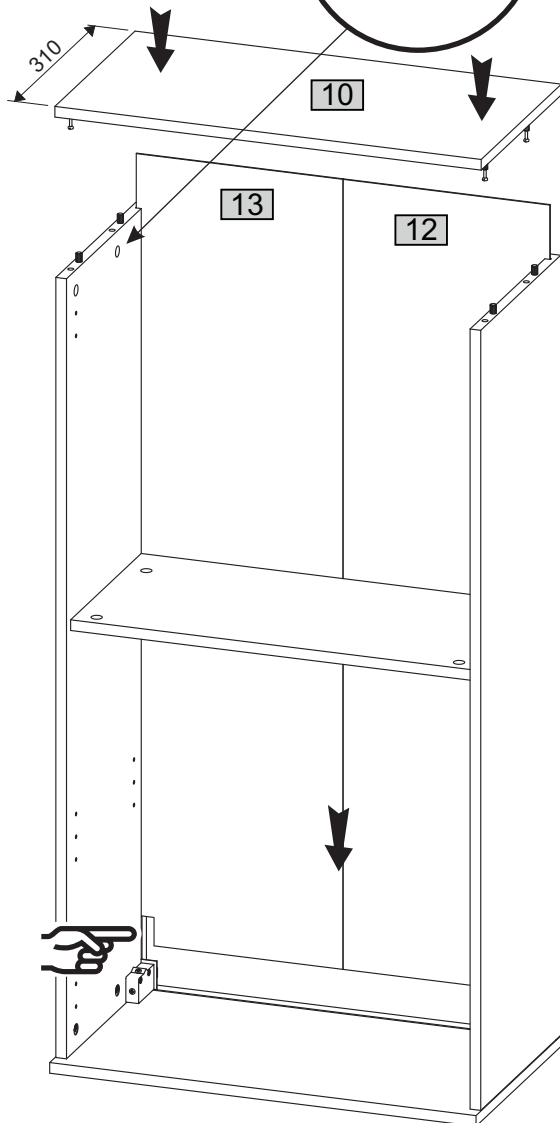
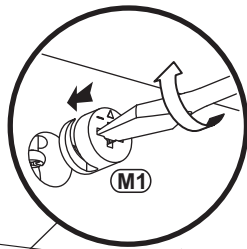

5

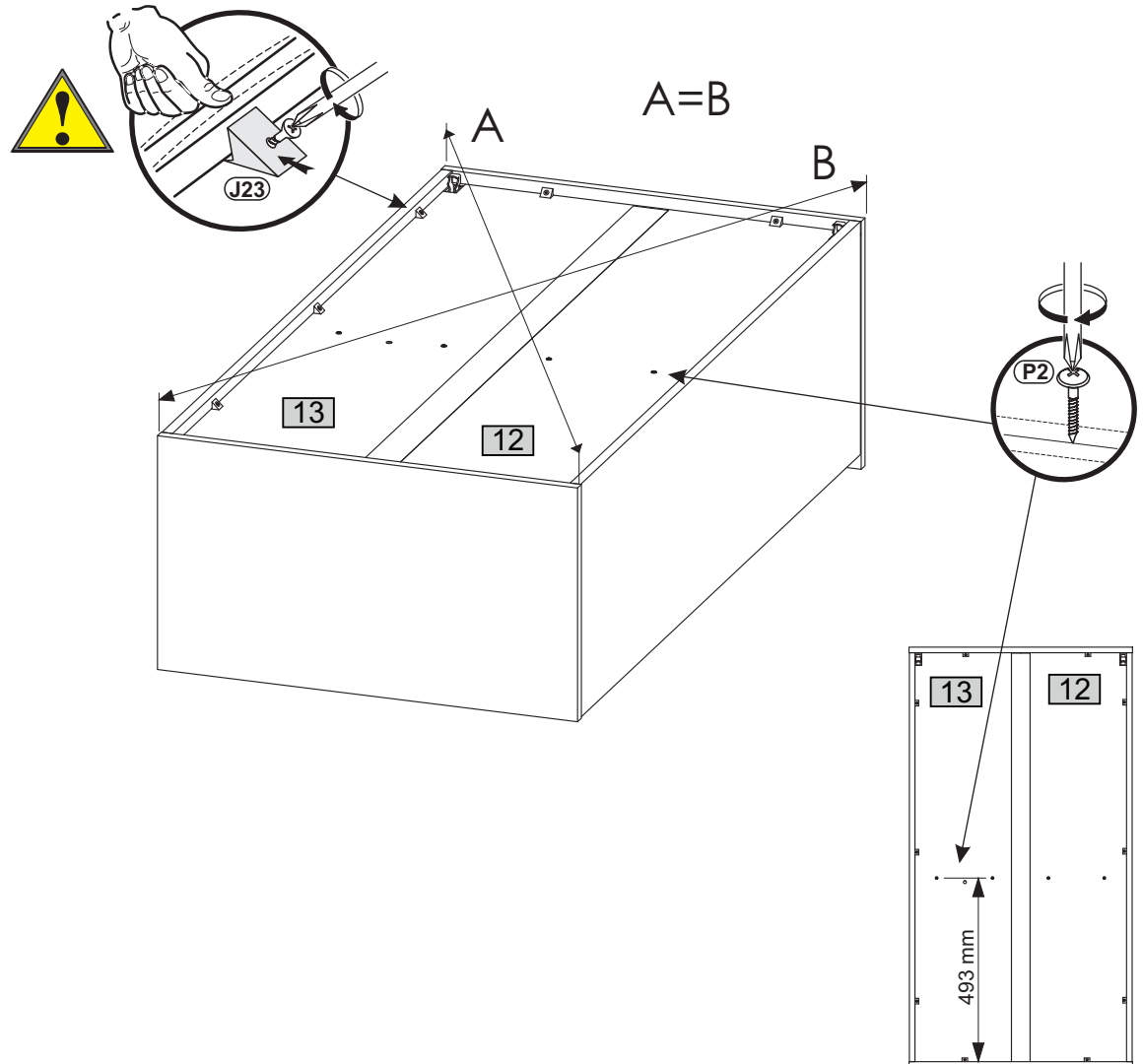
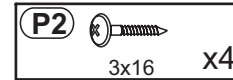
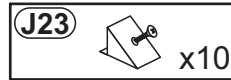



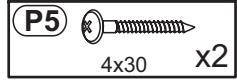
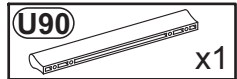
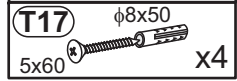
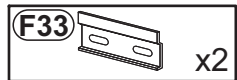



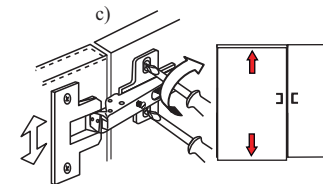
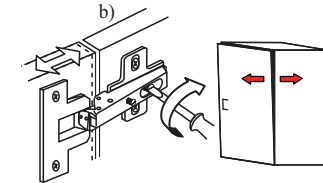
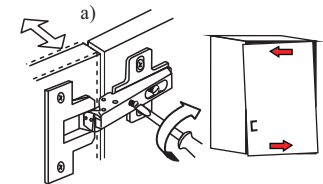
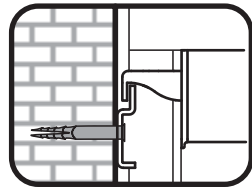
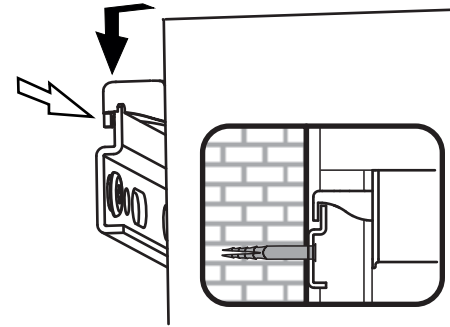
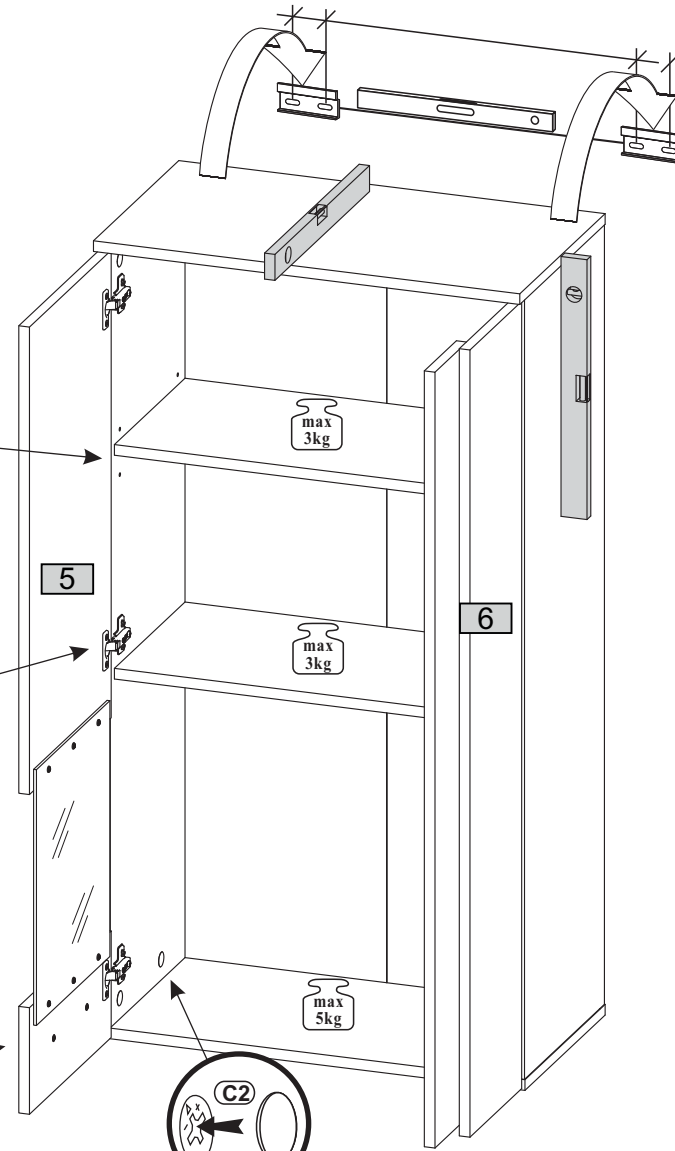
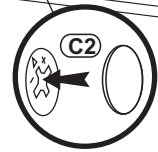
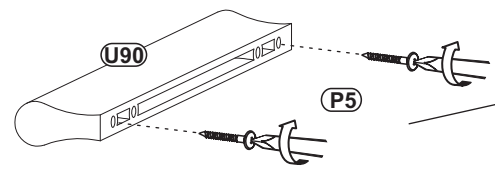
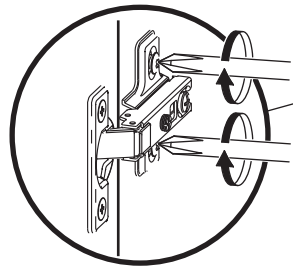
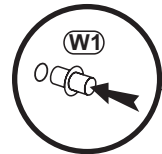
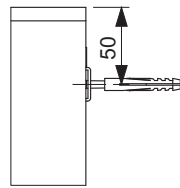
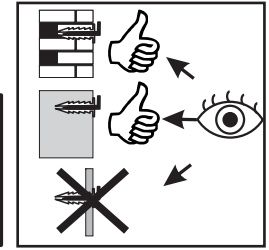
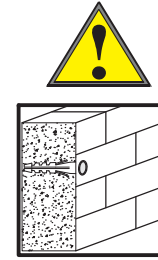
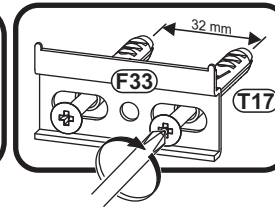
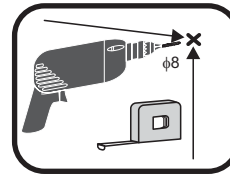

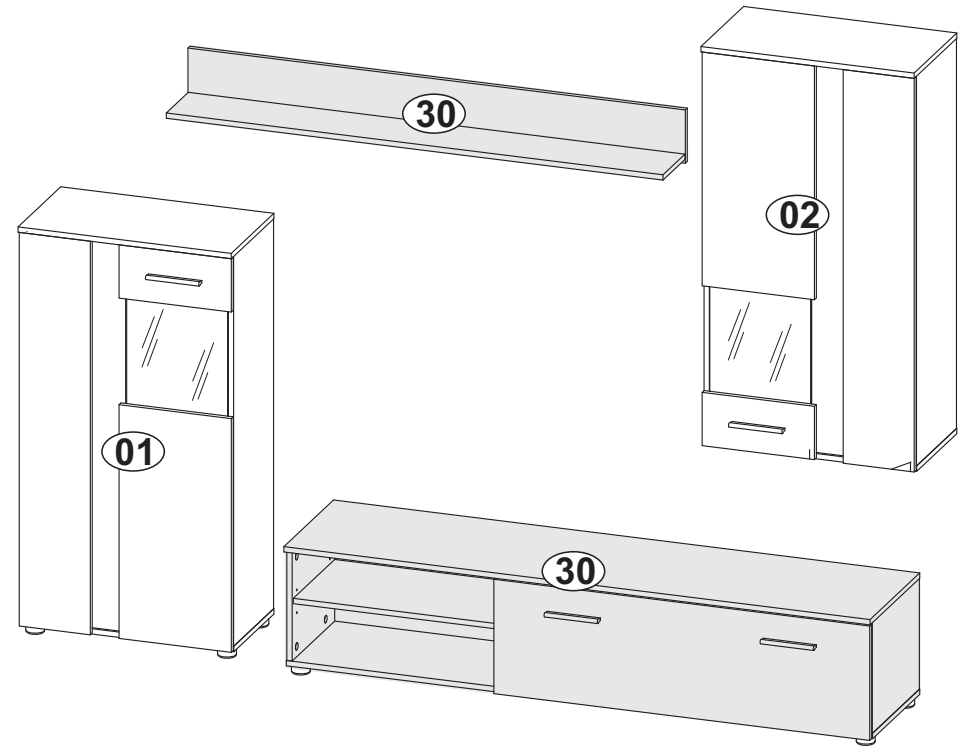
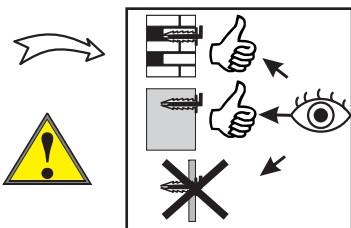
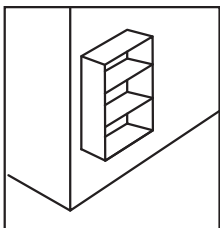
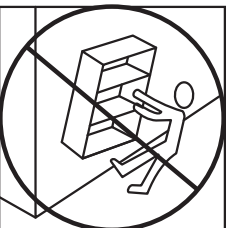
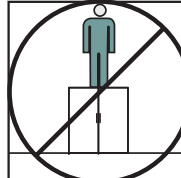
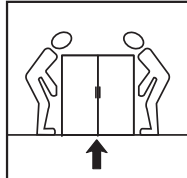
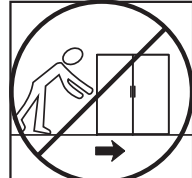
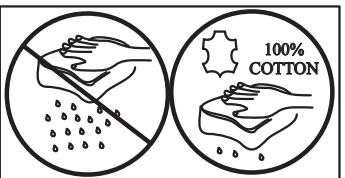
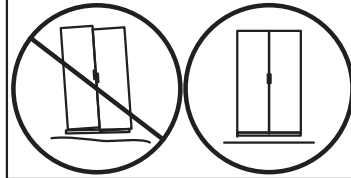
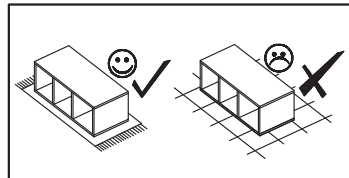
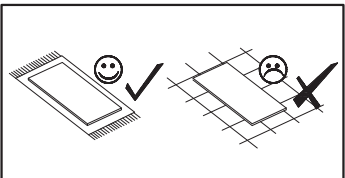
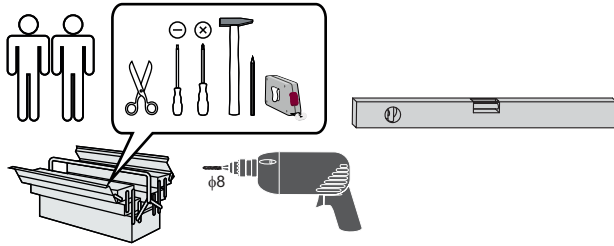
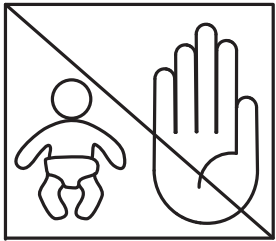

6

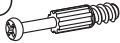







34 mm 32 468 mm 32 34 mm









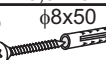



- B1**  ϕ 8x28 x12
- T1**  x16
- M1**  x16
- C2**  ϕ 20 x17
- W1**  x3
- W4**  x1
- S2**  3x13 x1
- J23**  x10
- P2**  3x16 x2

- F10**  x6
- P17**  4x20 x6
- U90**  x2
- P5**  4x30 x4

- J11**  x2
- P13**  3,5x13 x4
- T17**  ϕ 8x50
5x60 x3

- F50**  x3
- E4**  6x8 x6
- T10**  ϕ 8x50
 ϕ 4,5x60 x3
- K1**  7x50 x9
- L5**  x2

- Y0**  x2
- S8**  4x13 x4

- R20**  x1
- S3**  3,5x13 x6

Nr	Ausmaß			St
1	312	364	15	1
2	312	364	15	1
3	1058	322	15	1
4	1400	150	15	1
5	312	329	15	1
6	572	320	15	1
7	1398	170	15	1
8	312	100	15	1
9	1650	365	15	1
10	1650	384	15	1
11	1632	326	2	1

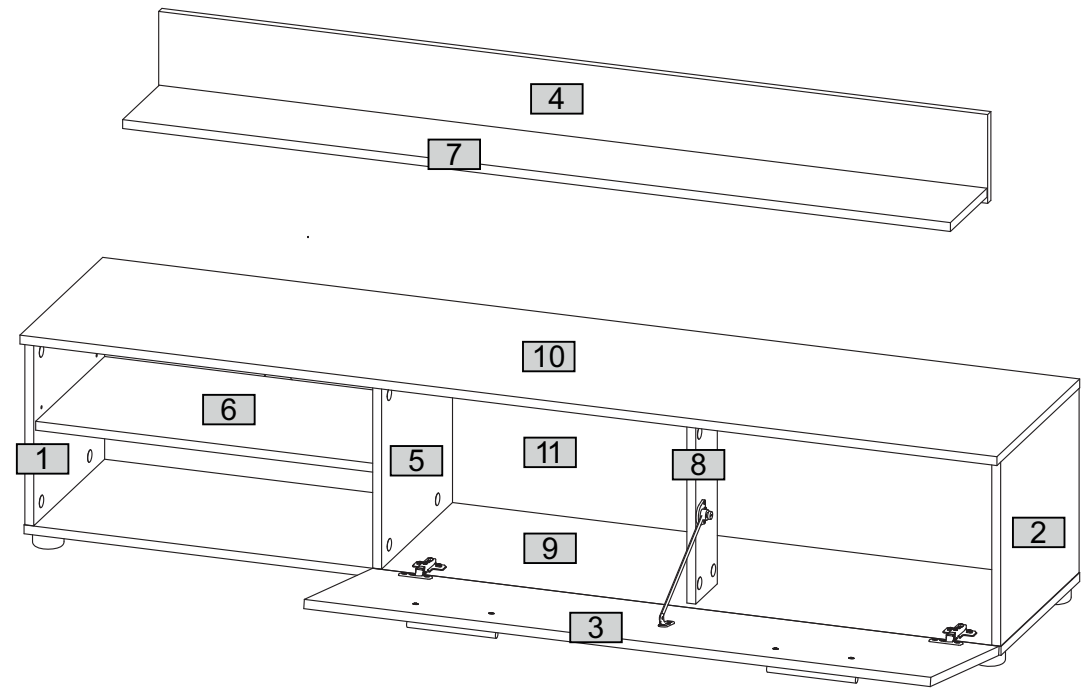

0 10 20 30 40 50 60 70 80 90 100 110 120 130 140 150 160 170 180 190 200



1

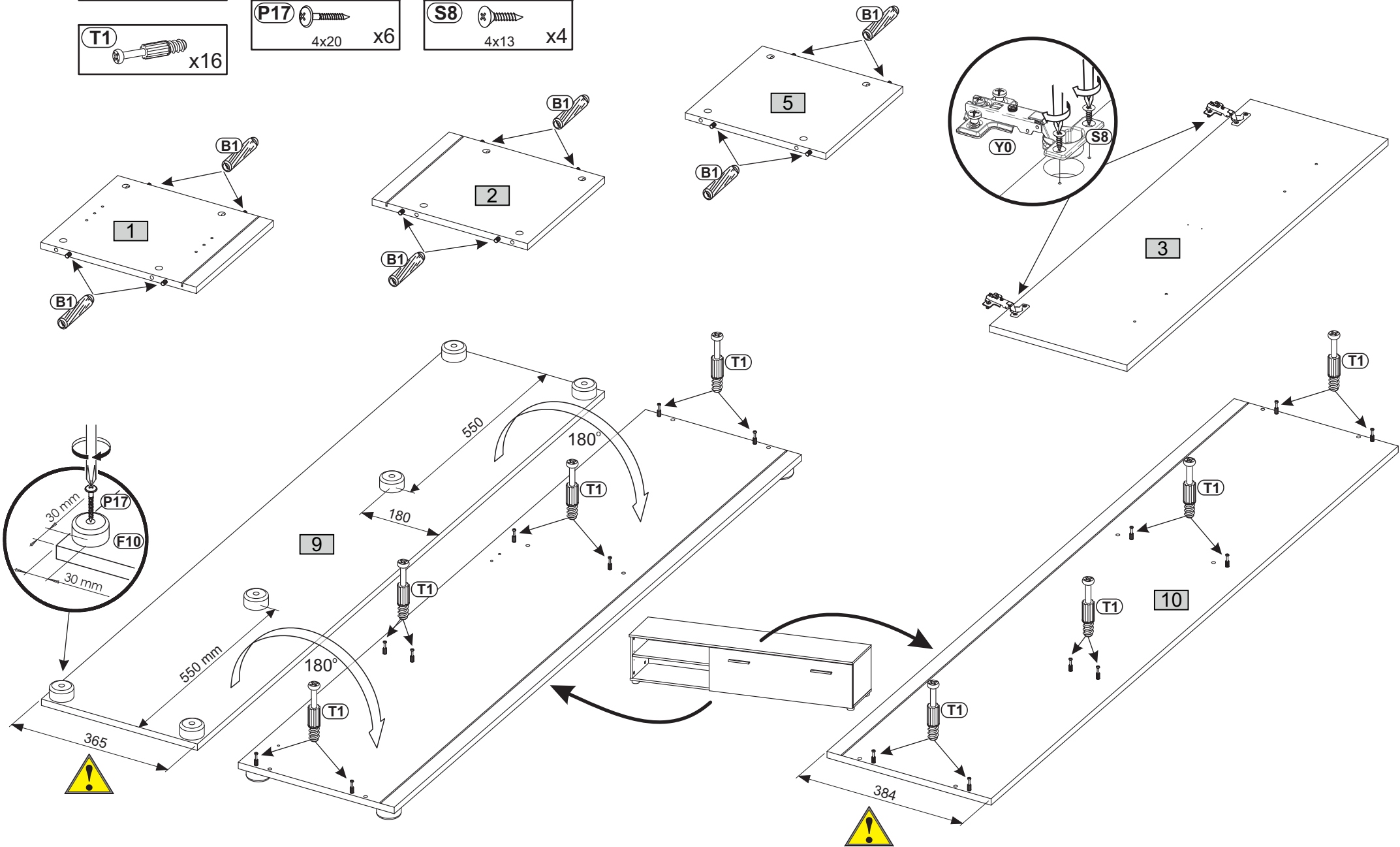
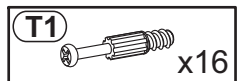
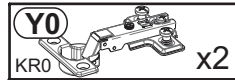
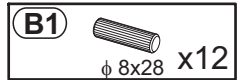

2

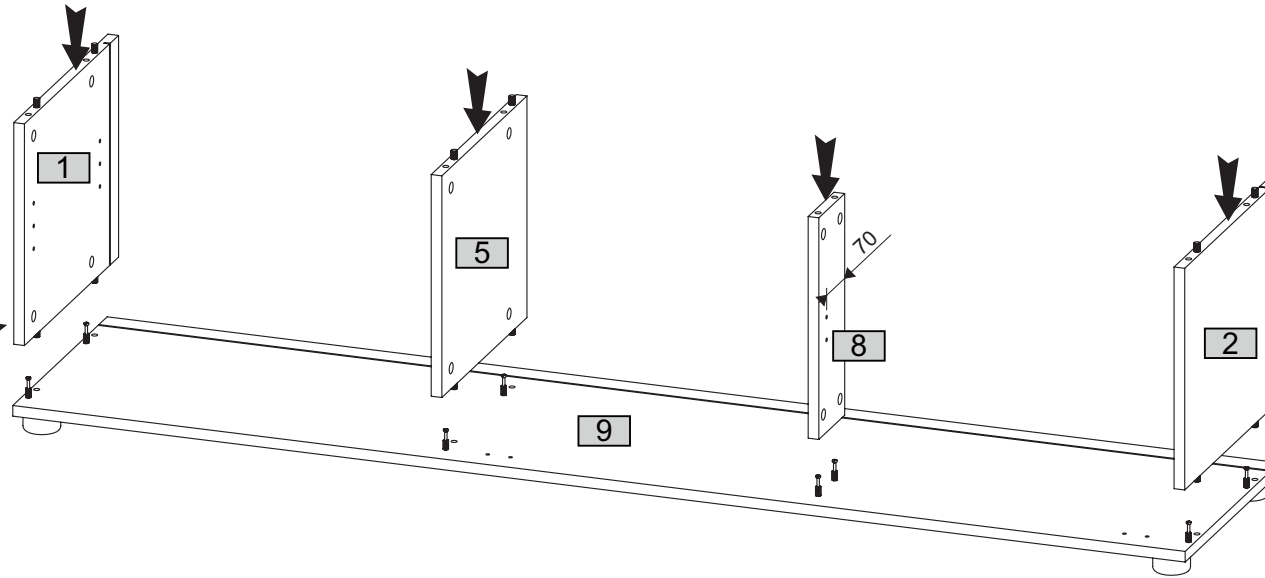
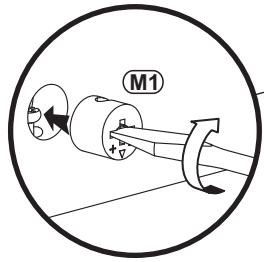

3

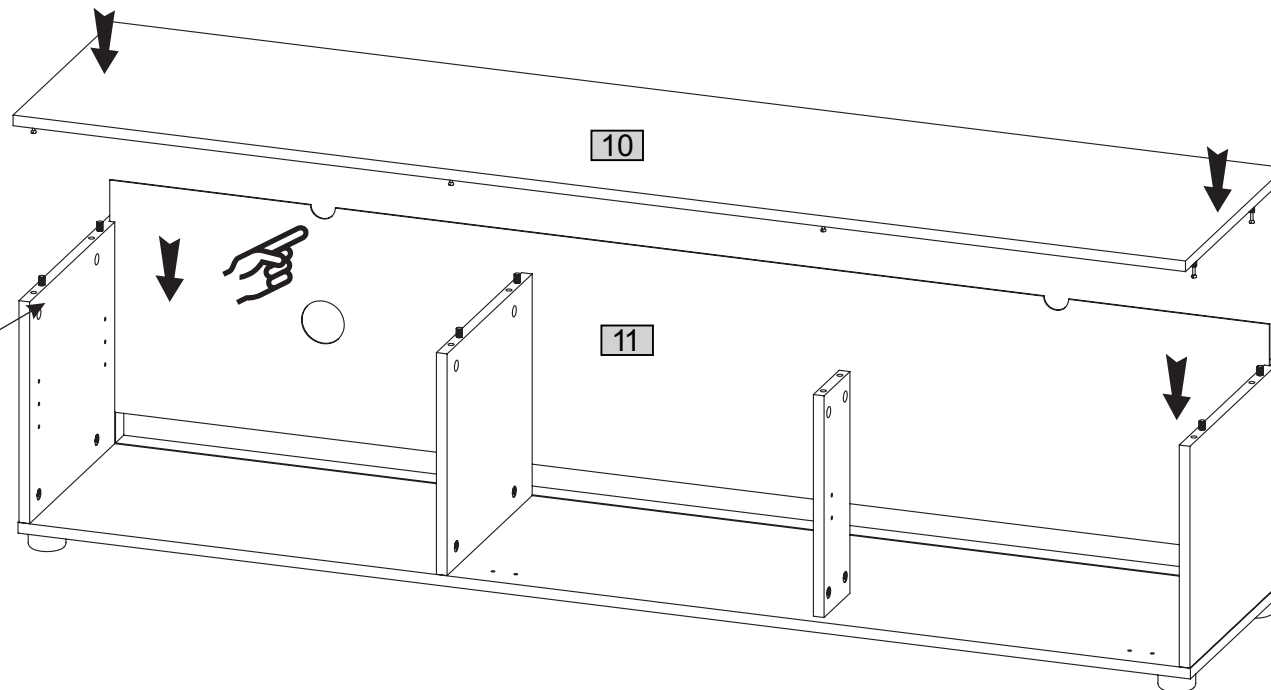
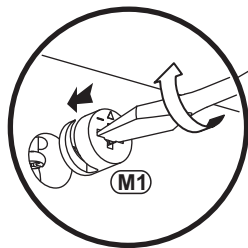

4

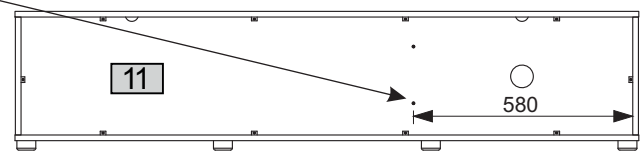
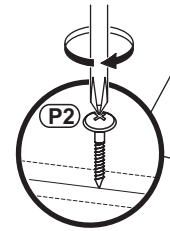
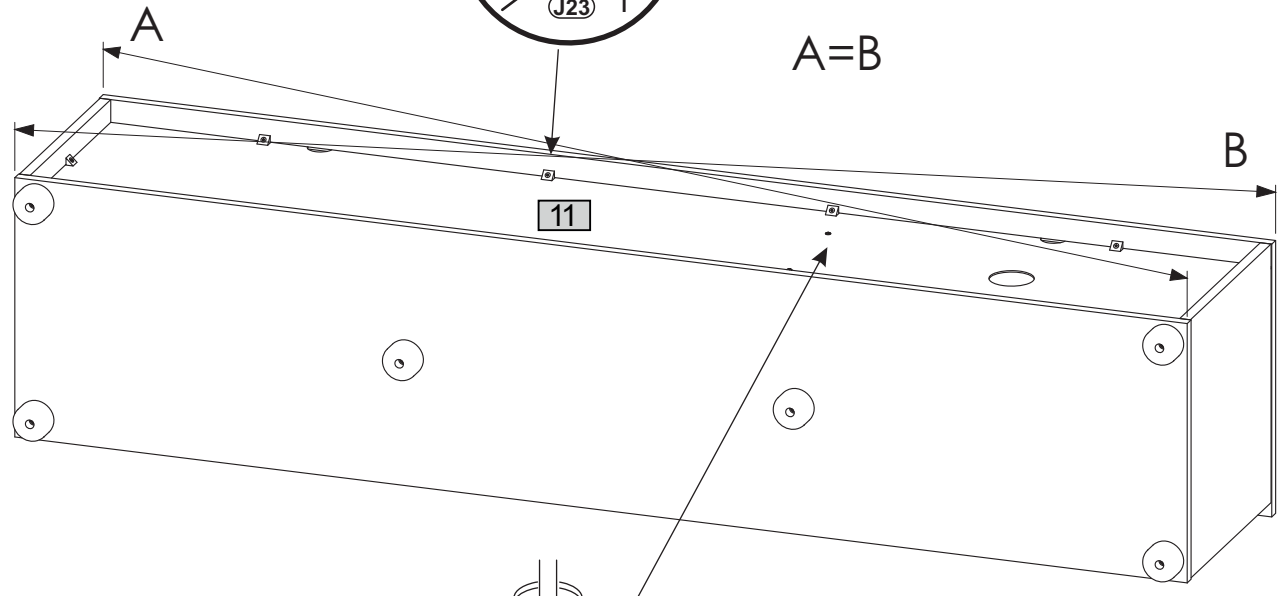
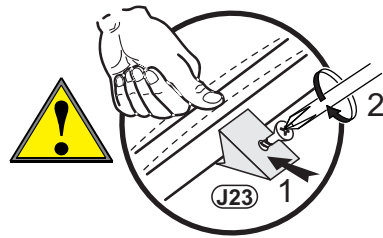
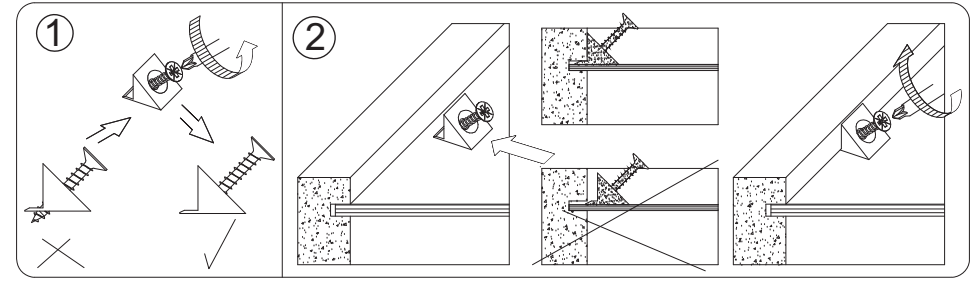
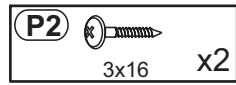
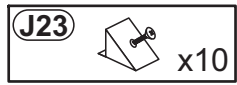

5

- U90** x2
- J11** x2
- P13** 3,5x13 x4
- T17** $\phi 8 \times 50$ 5x60 x2
- P5** 4x30 x4
- W4** x1
- W1** x3
- C2** $\phi 20$ x16
- S2** 3x13 x1
- R20** x1
- S3** 3,5x13 x6

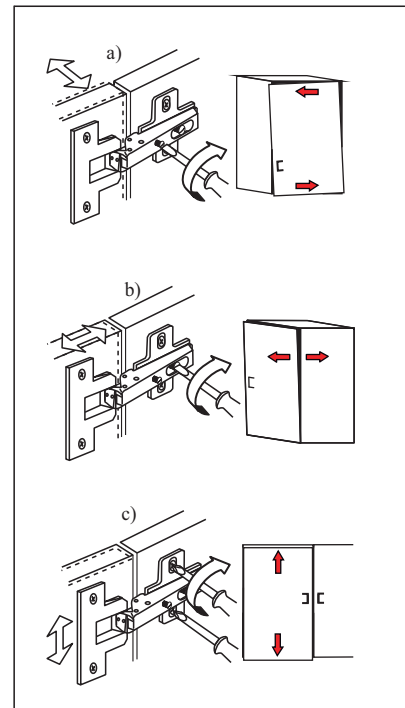
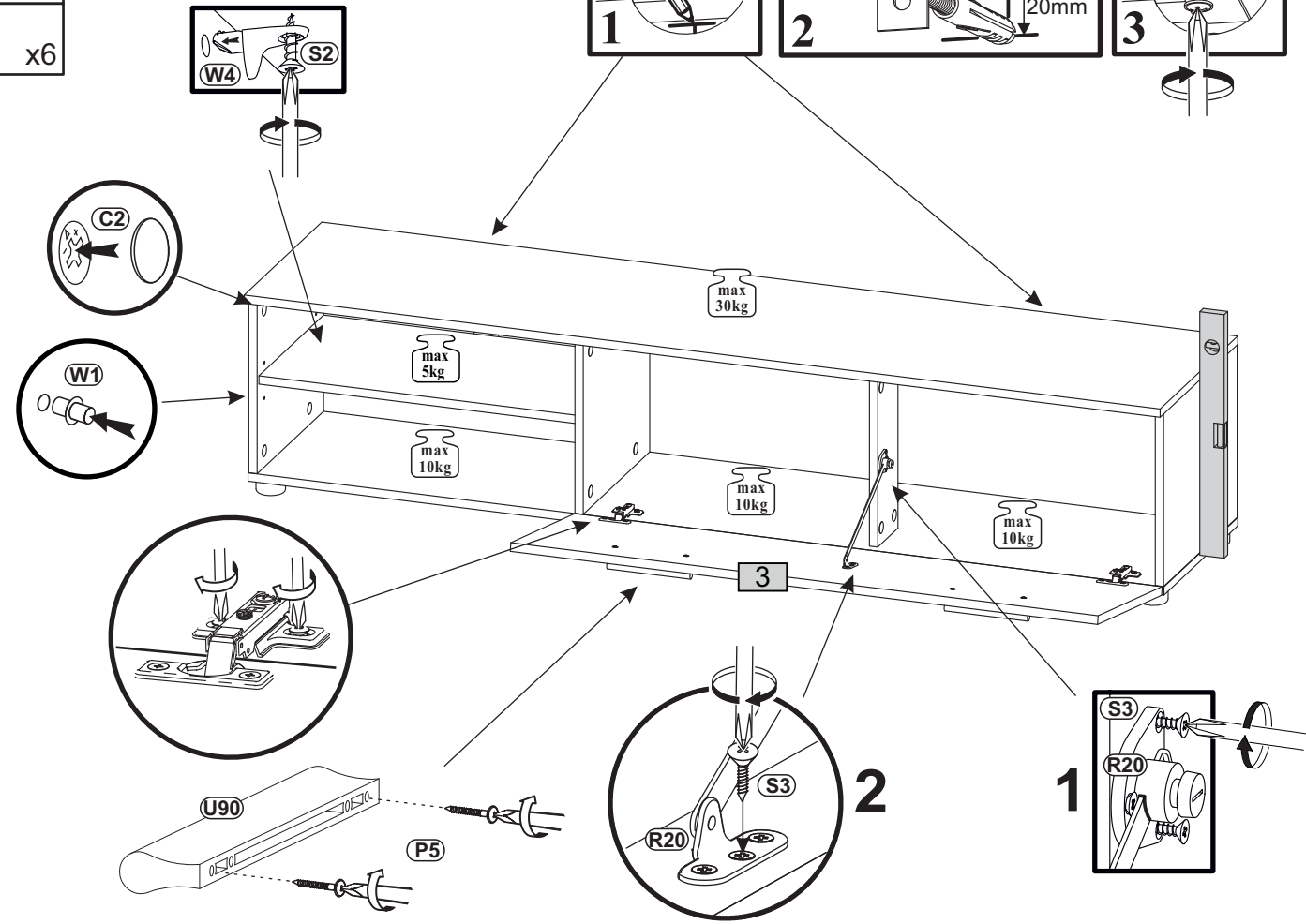
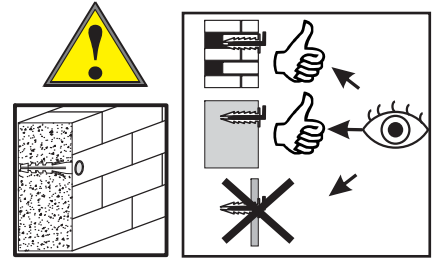
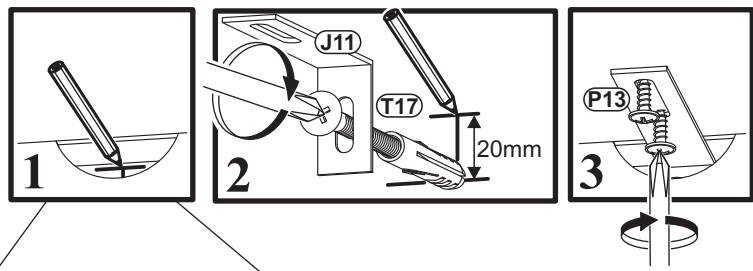

6

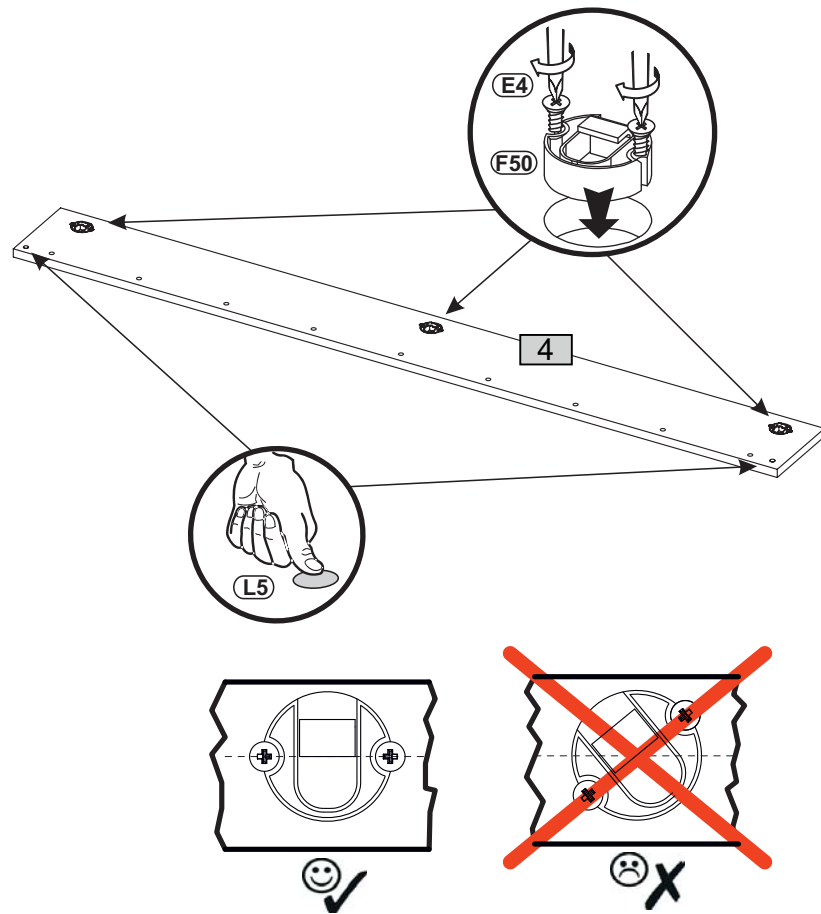
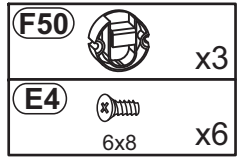

7

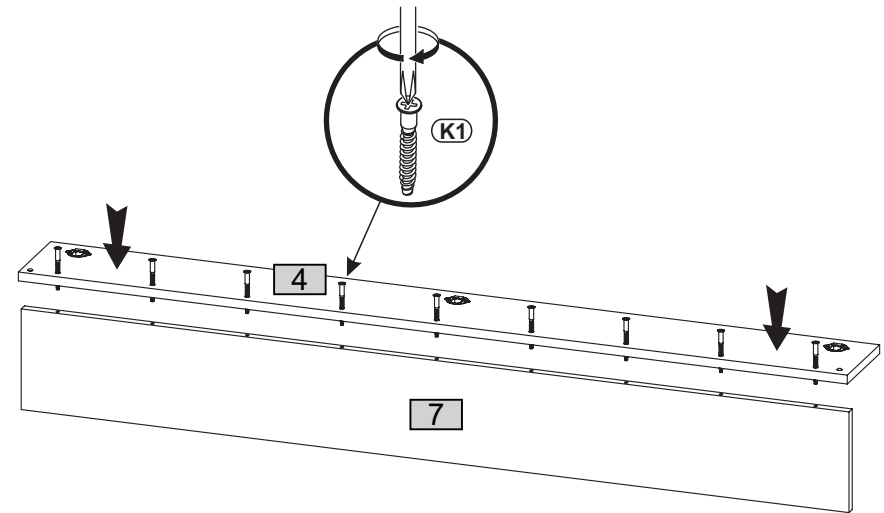
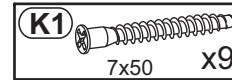

8

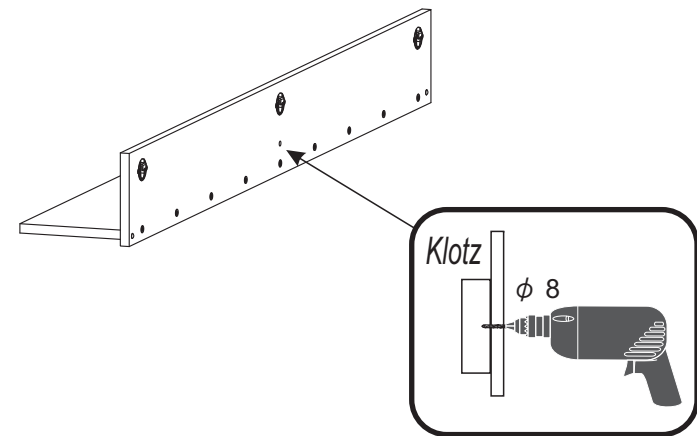

9

- T10** $\phi 8 \times 50$
 $\phi 4,5 \times 60$ x3
- T17** $\phi 8 \times 50$
5x60 x1
- C2** $\phi 20$ x1

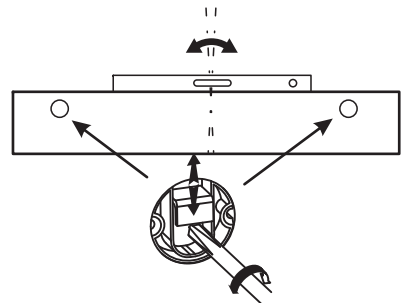
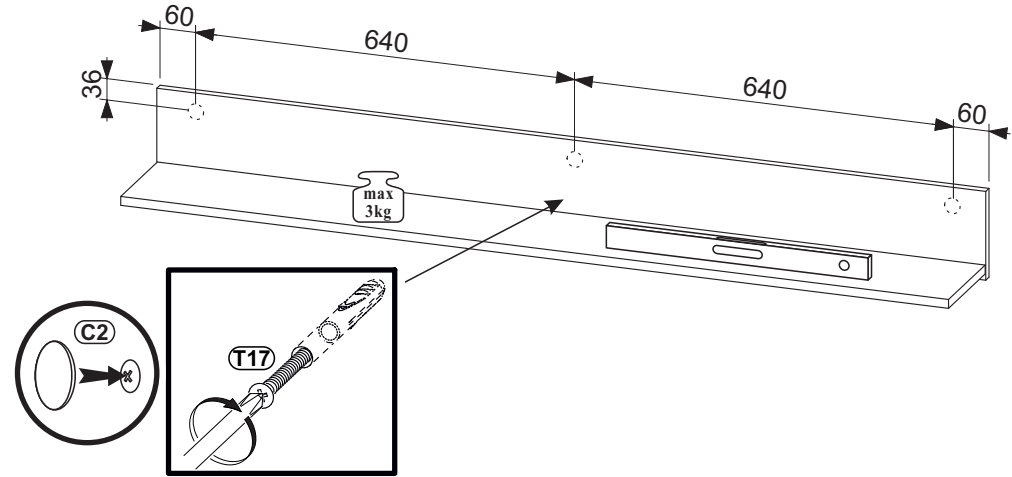
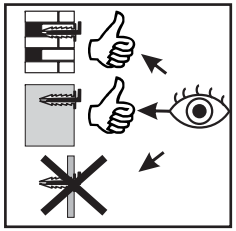
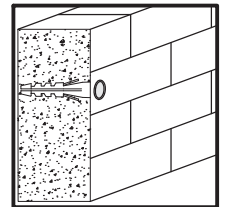
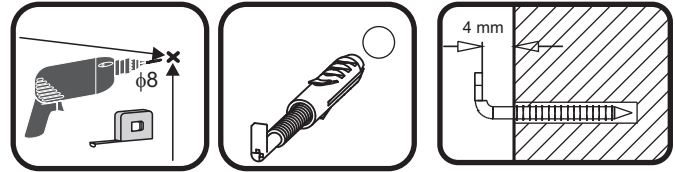

10

