

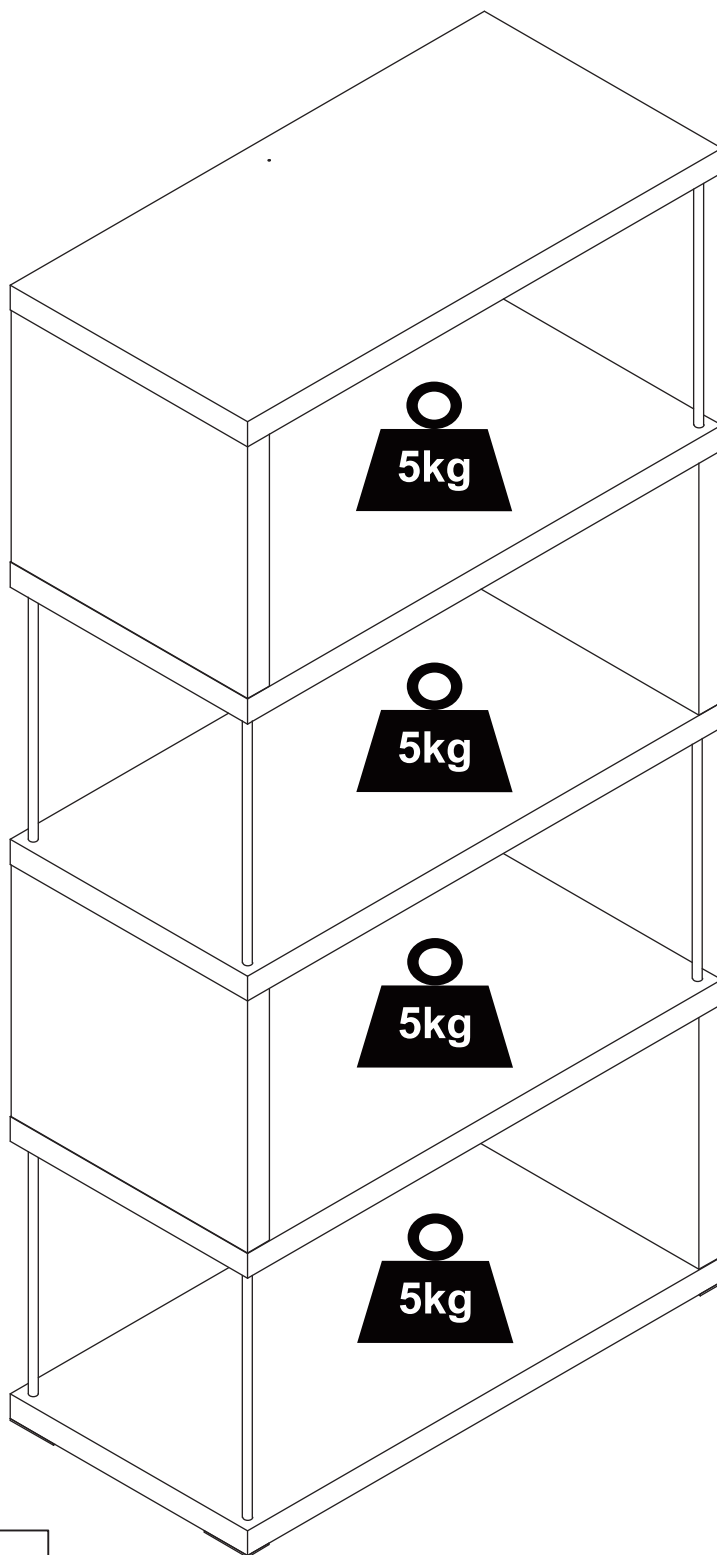

# 79680370/01/02/03 PINNAR



 x2	 x15
---	--



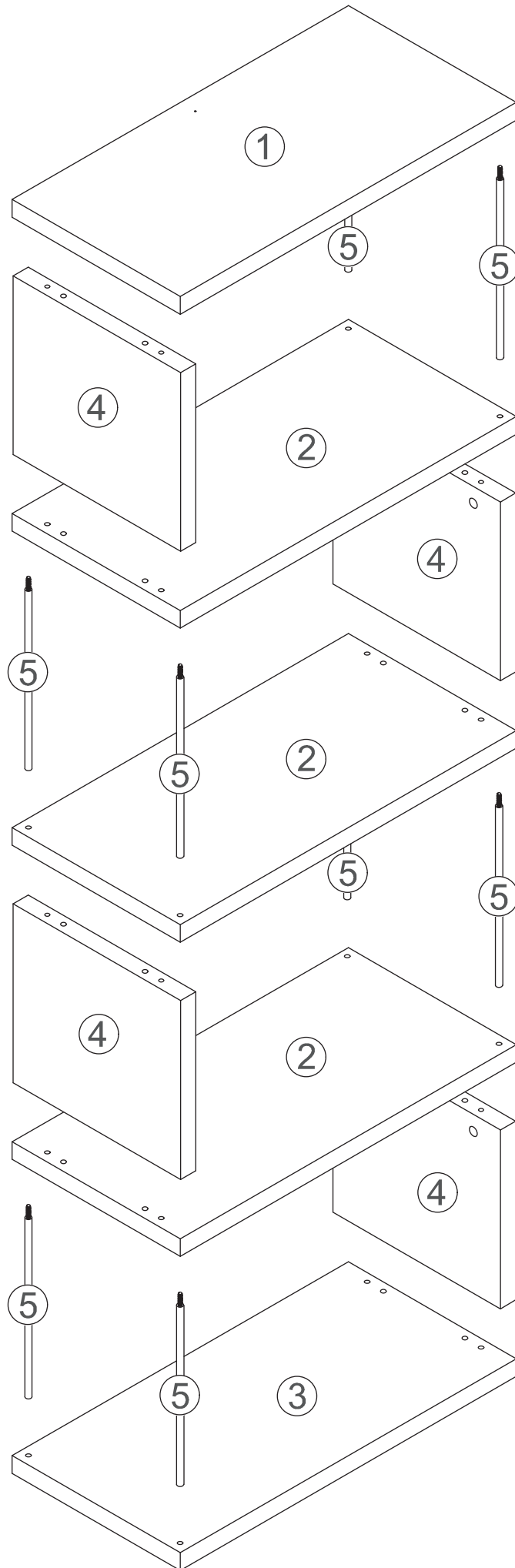
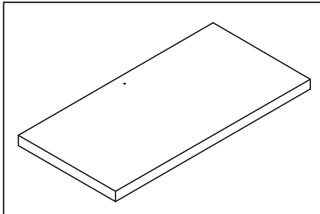

1 x1

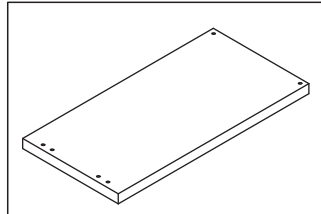

2 x3

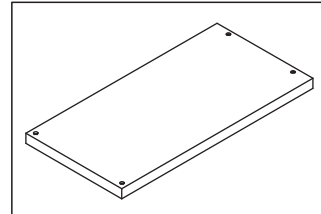

3 x1

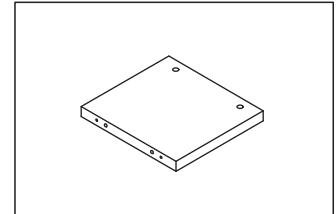

4 x4

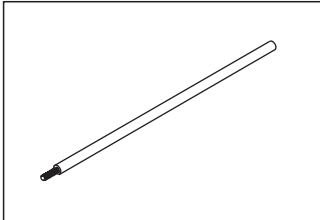

5 x8

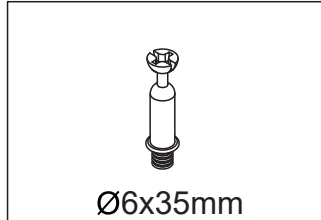

A Ø6x35mm x8



B Ø15xD9mm x8

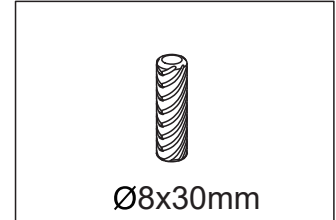

C Ø8x30mm x16

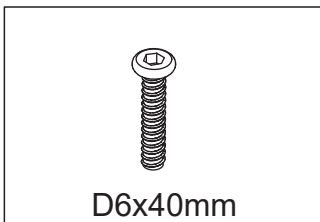

D D6x40mm x8



E D4x14mm x1

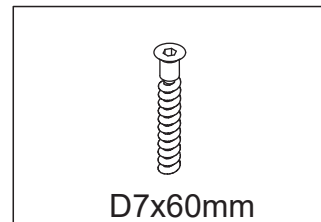

F D7x60mm x8

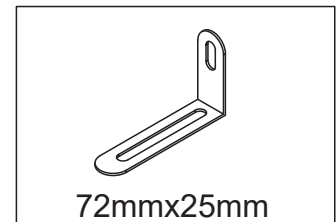

G 72mmx25mm x1

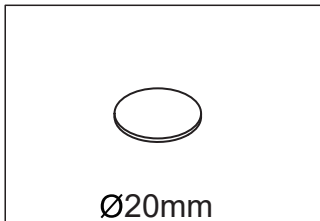

H Ø20mm x8

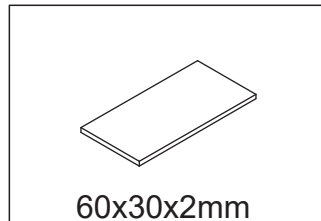

I 60x30x2mm x4

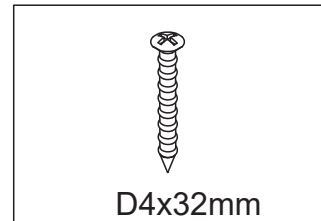

J D4x32mm x1

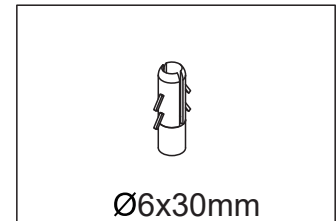

K Ø6x30mm x1

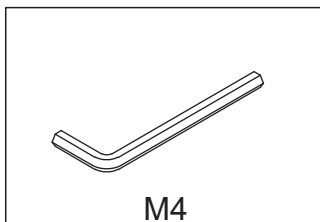

U M4 x1

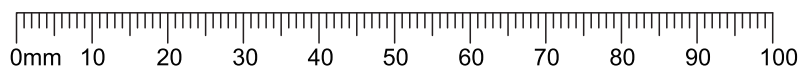

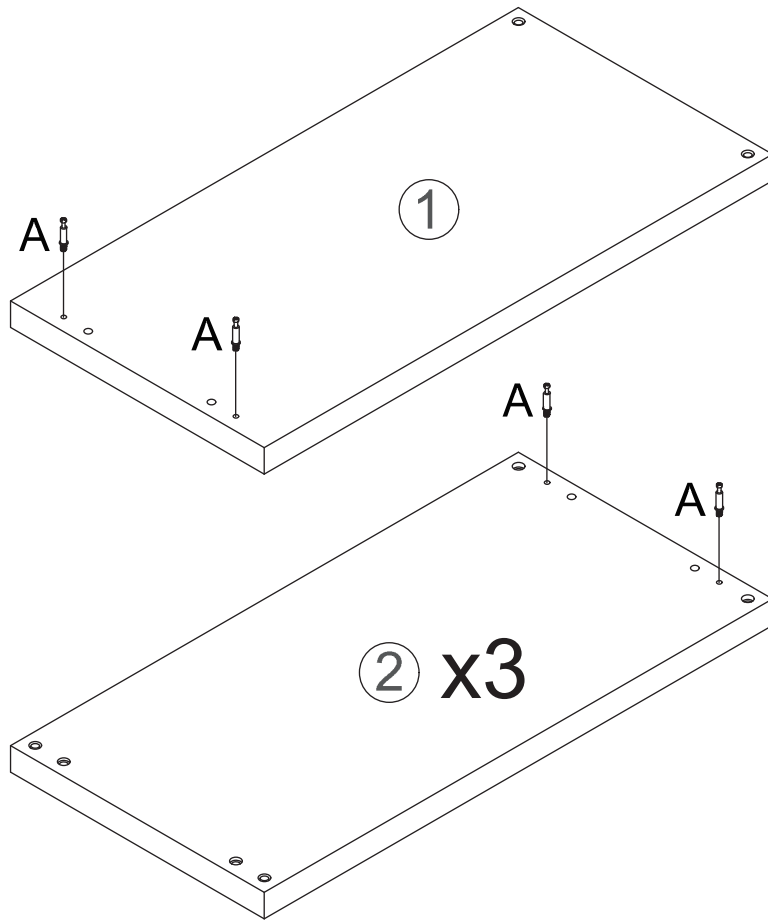

01

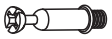

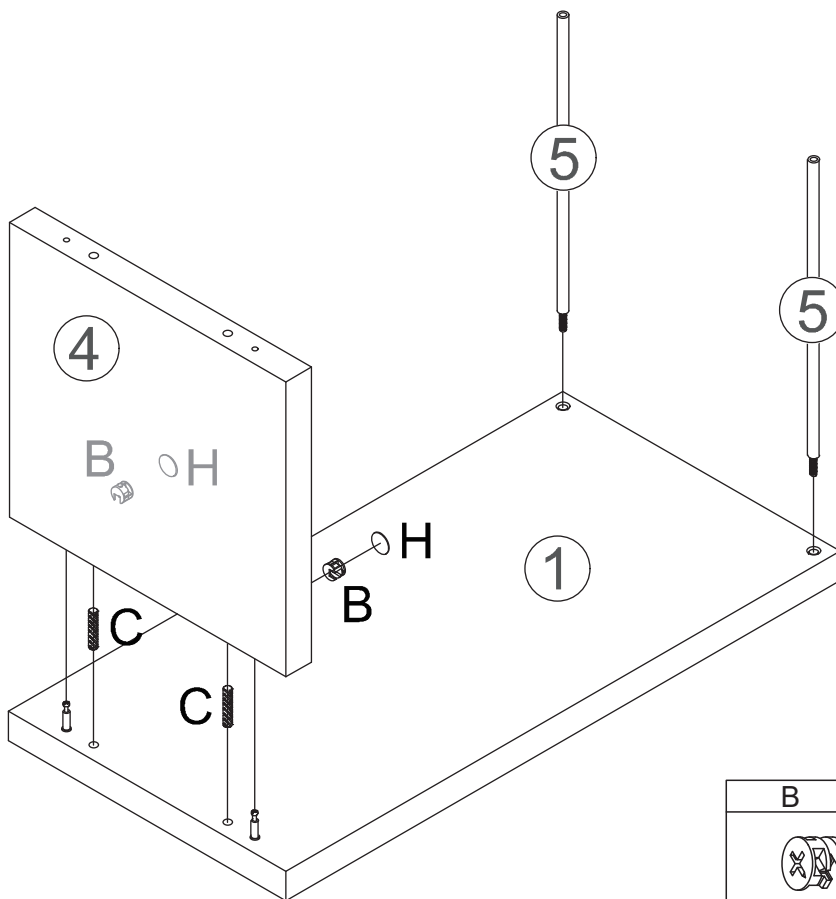

A	x8
	
Ø6x35mm	

02





B	x2
	
Ø15xD9mm	

C	x2
	
Ø8x30mm	

H	x2
	
Ø20mm	

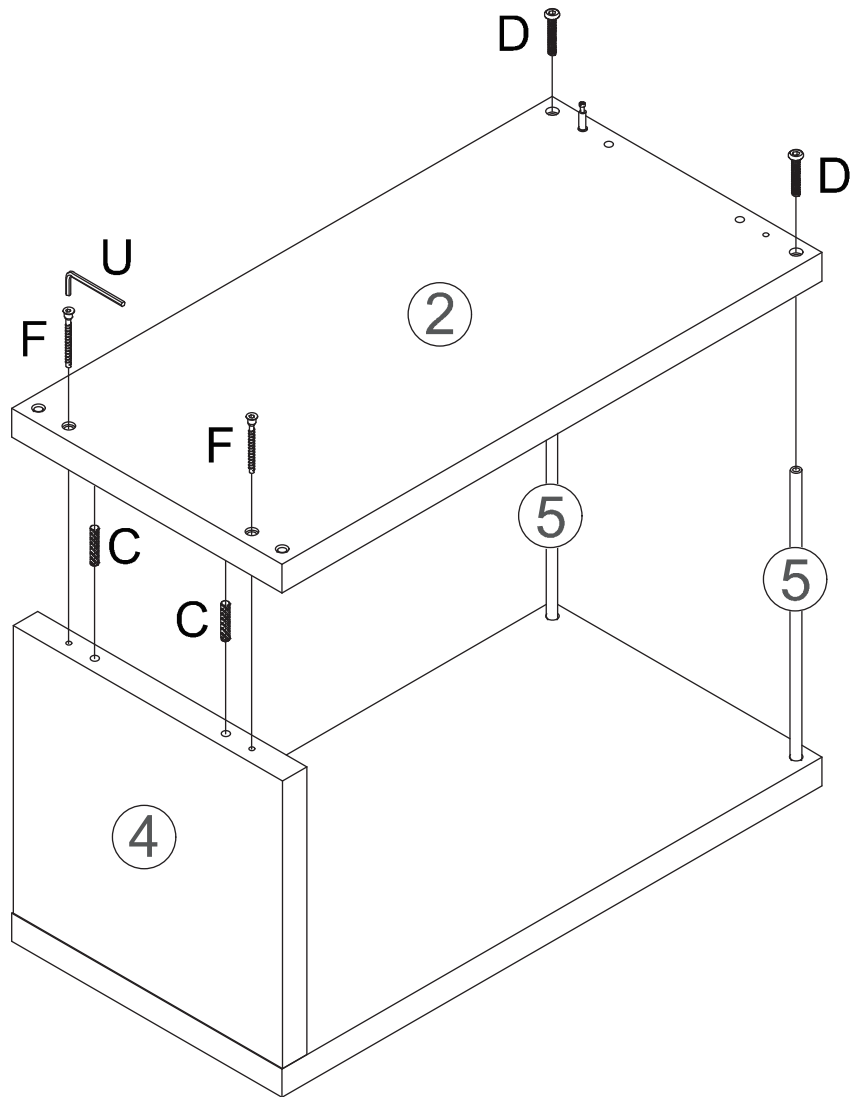
03



C	x2
	
Ø6x30mm	

D	x2
	
D6x40mm	

F	x2
	
D7x60mm	

U	x1
	
M4	

04

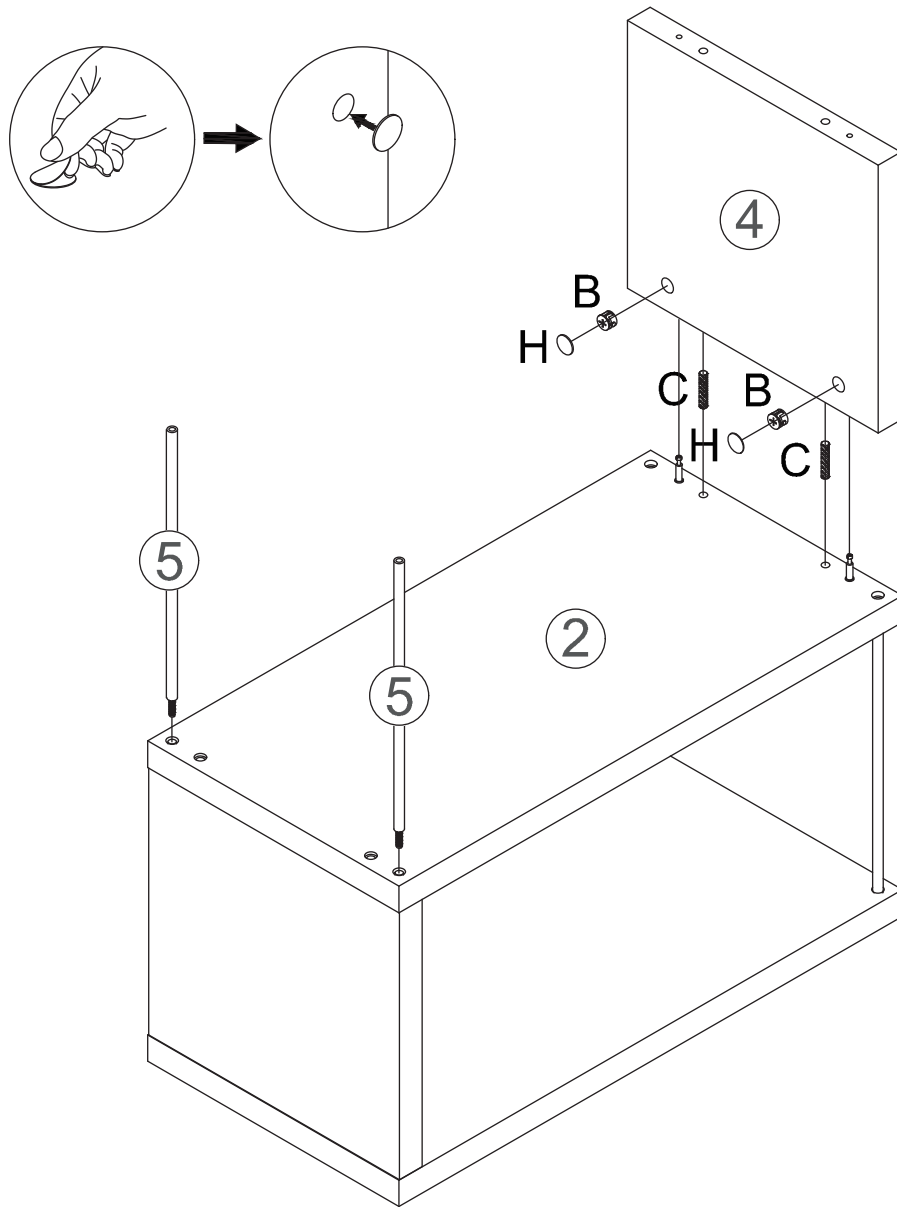



B	x2
	
Ø15xD9mm	

C	x2
	
Ø8x30mm	

H	x2
	
Ø20mm	

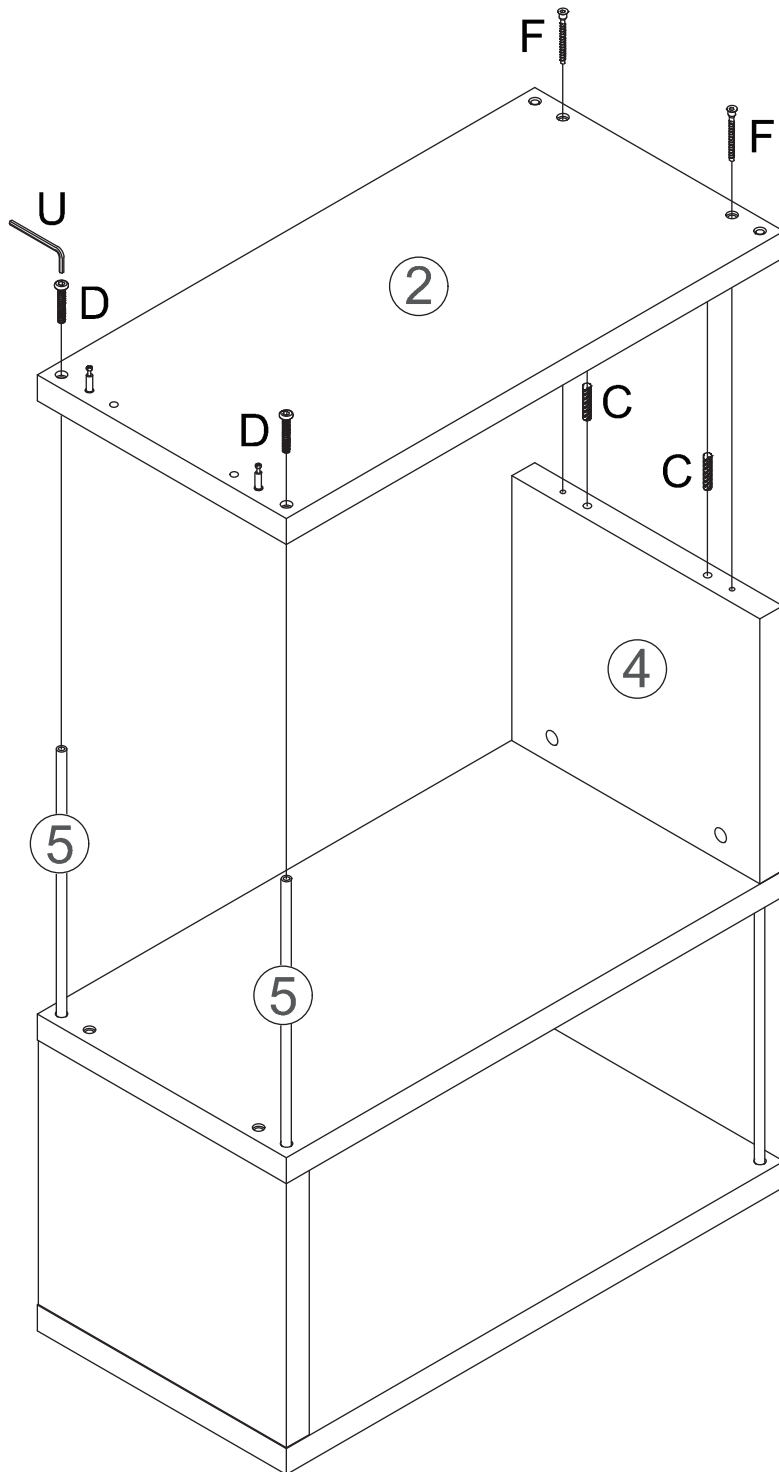
05



C	x2
	
Ø6x30mm	

D	x2
	
D6x40mm	

F	x2
	
D7x60mm	

U	x1
	
M4	

06

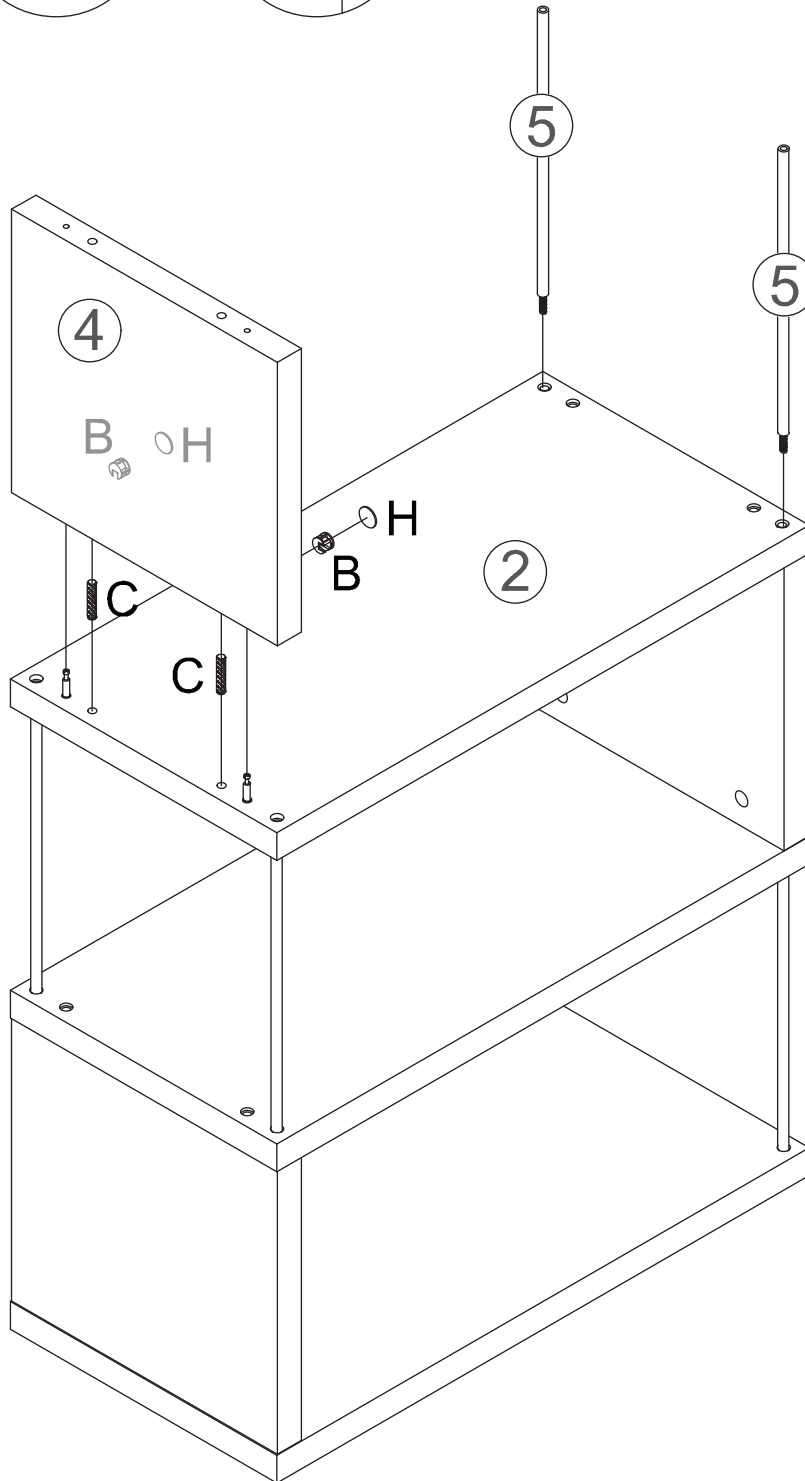
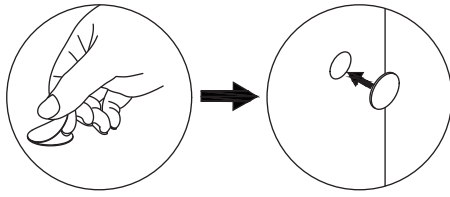



B	x2
	
Ø15xD9mm	

C	x2
	
Ø8x30mm	

H	x2
	
Ø20mm	

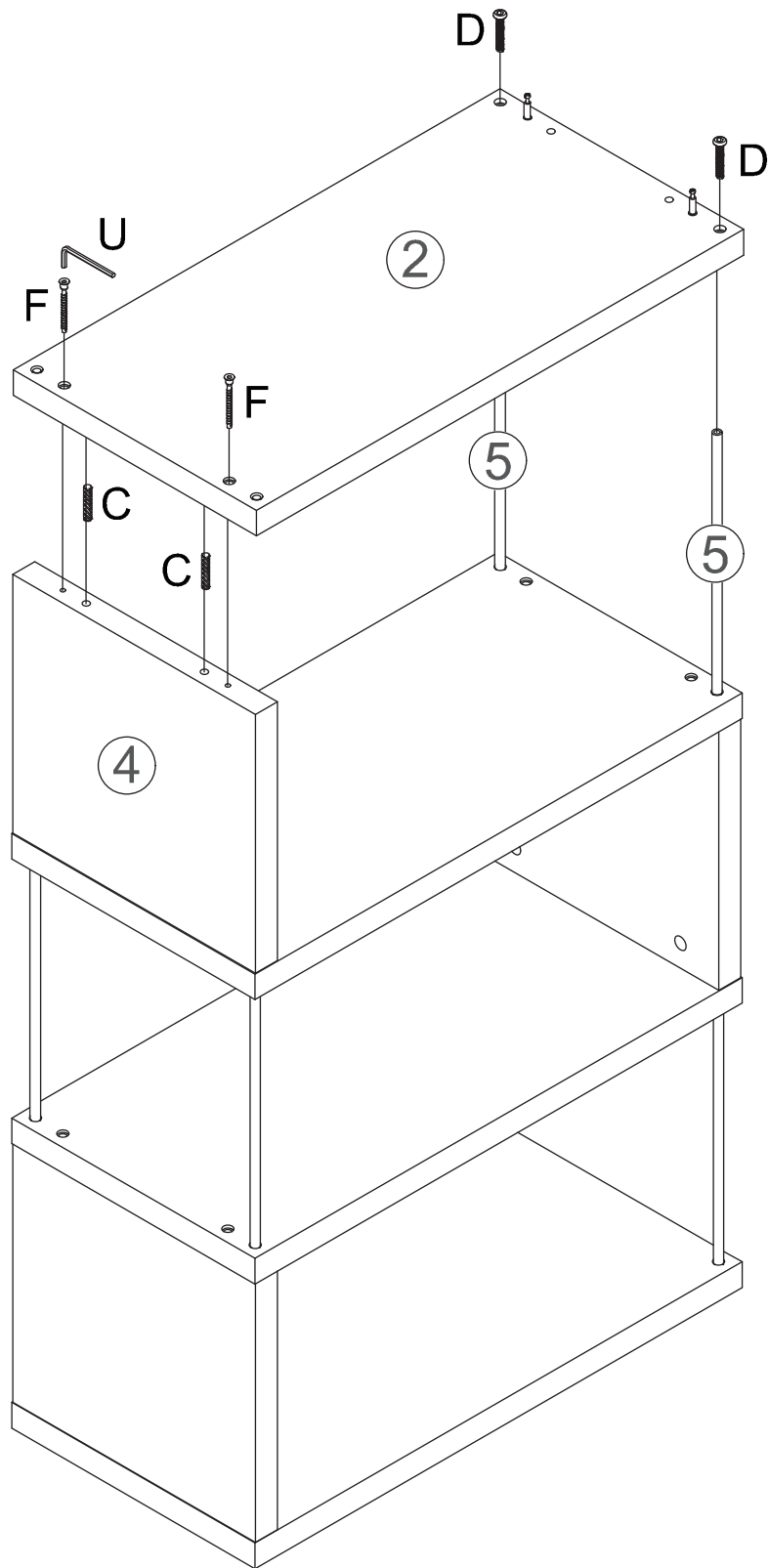
07



C	x2
	
Ø6x30mm	

D	x2
	
D6x40mm	

F	x2
	
D7x60mm	

U	x1
	
M4	

08

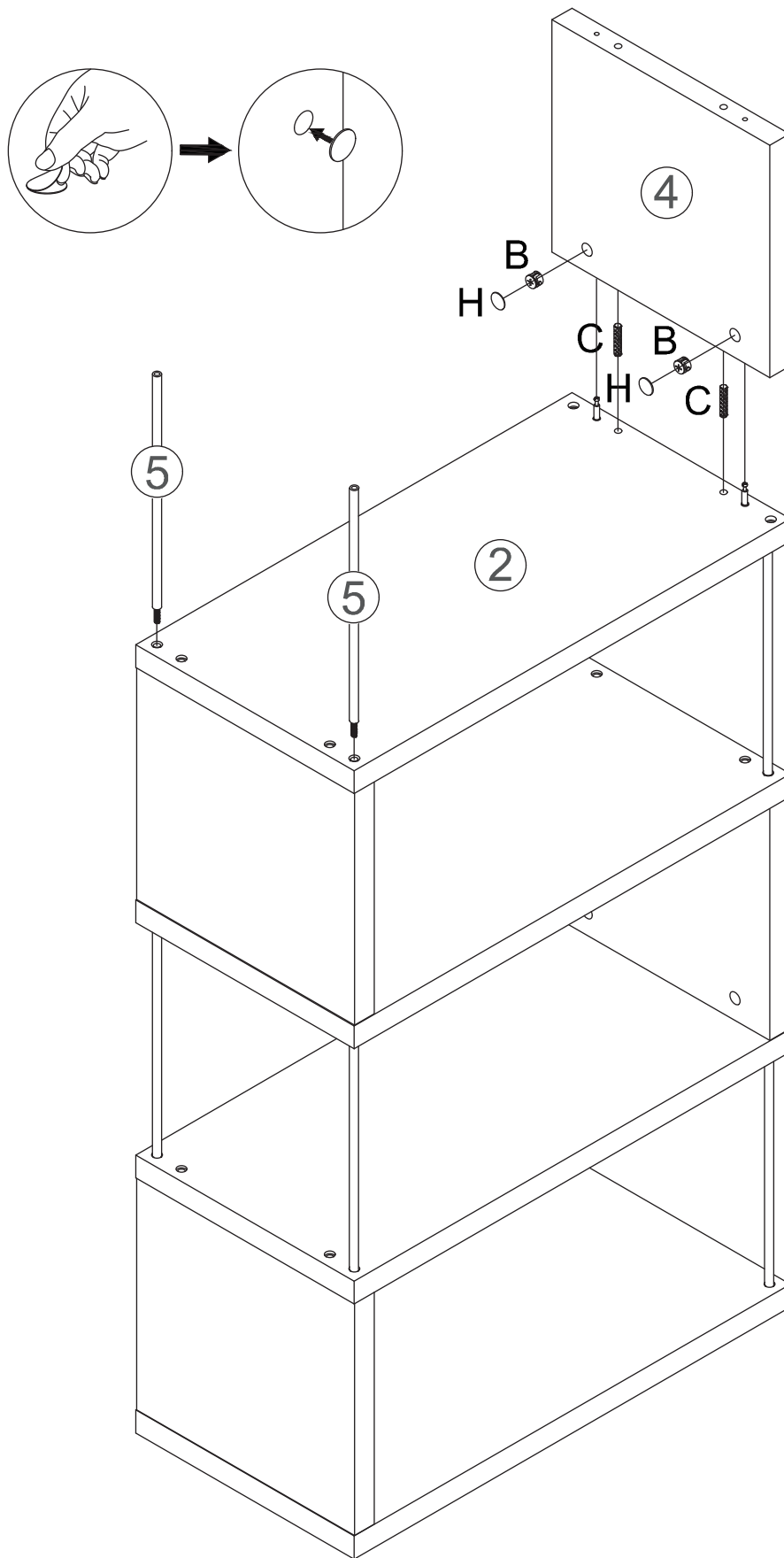



B	x2
	
Ø15xD9mm	

C	x2
	
Ø8x30mm	

H	x2
	
Ø20mm	

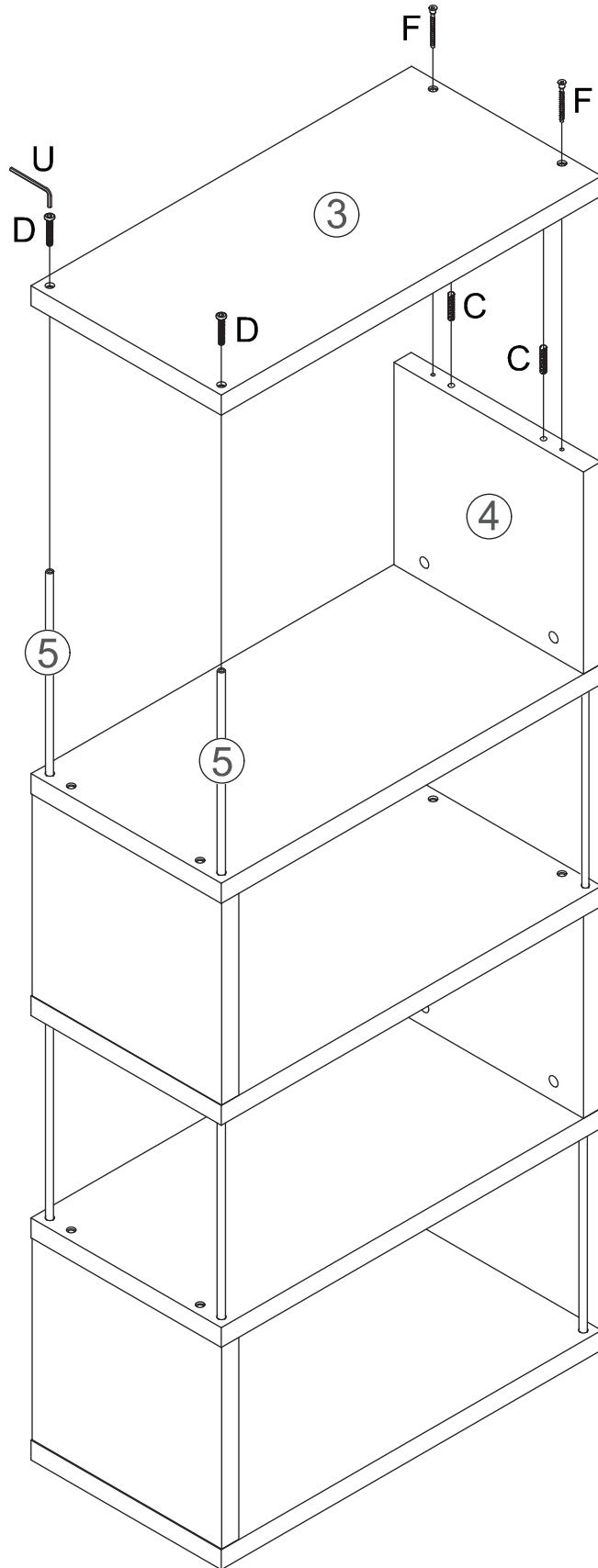
09

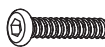

C	x2
	
Ø6x30mm	

D	x2
	
D6x40mm	

F	x2
	
D7x60mm	

U	x1
	
M4	

10

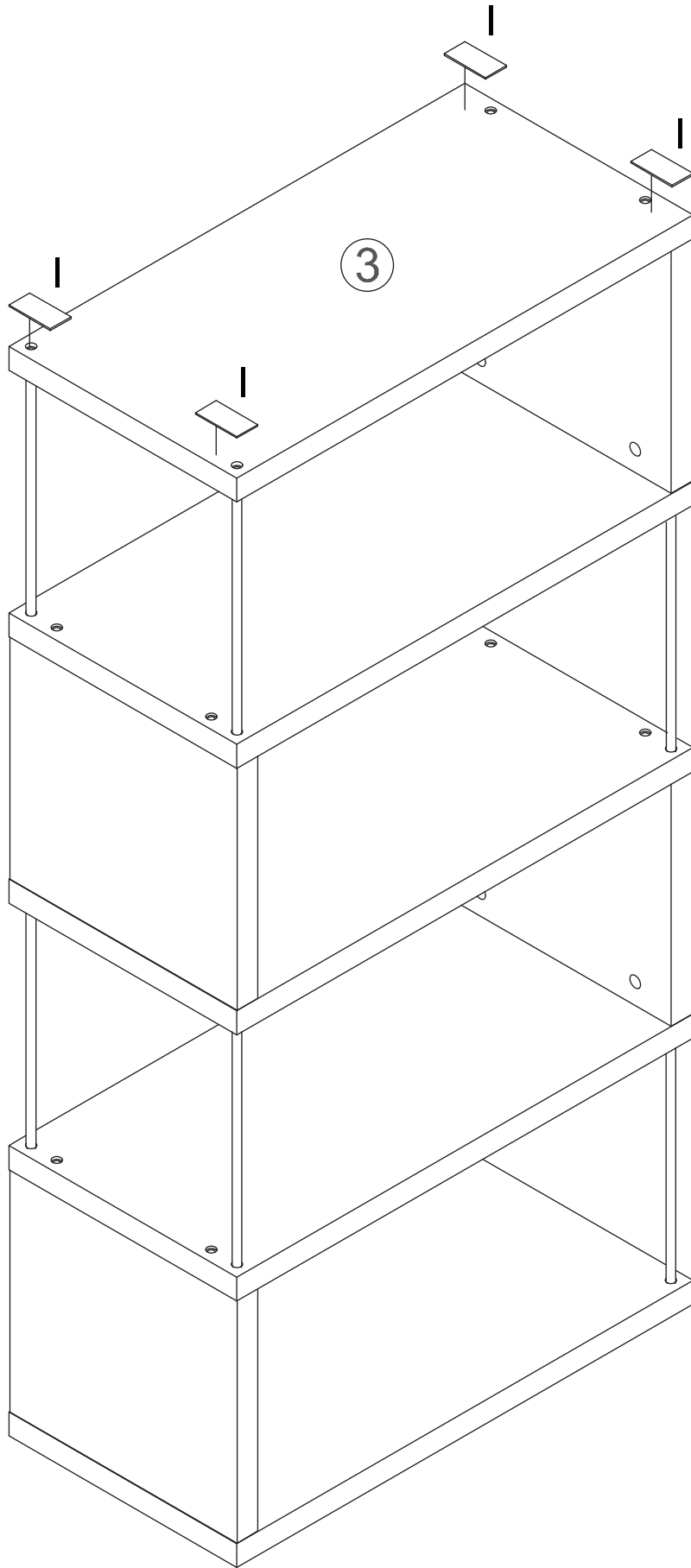

I	x4
60x30x2mm	

11

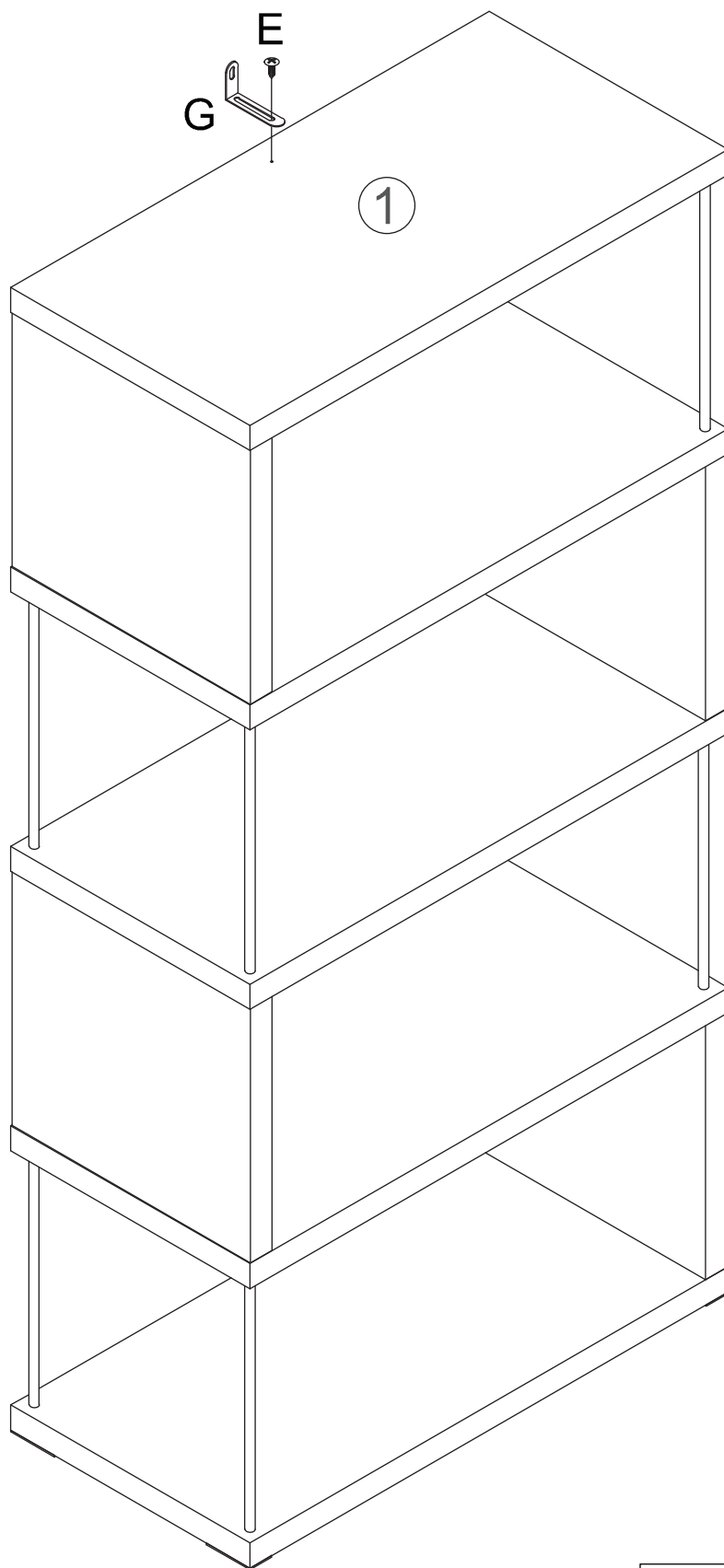



E	x1
	
D4x14mm	

G	x1
	
72mmx25mm	

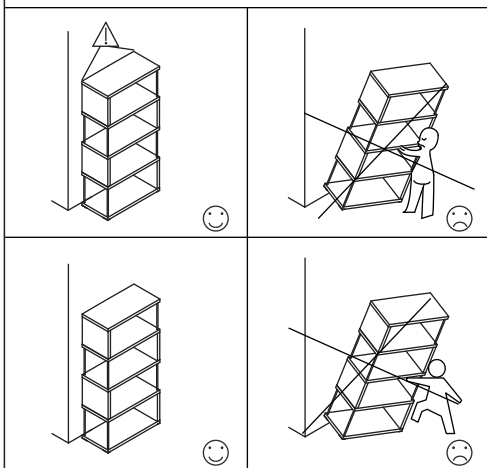
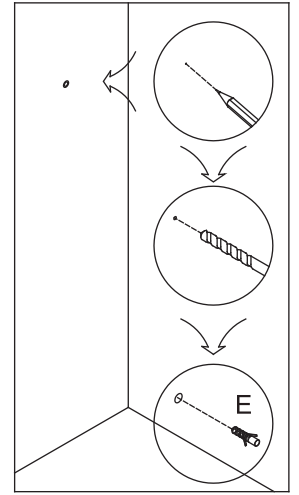
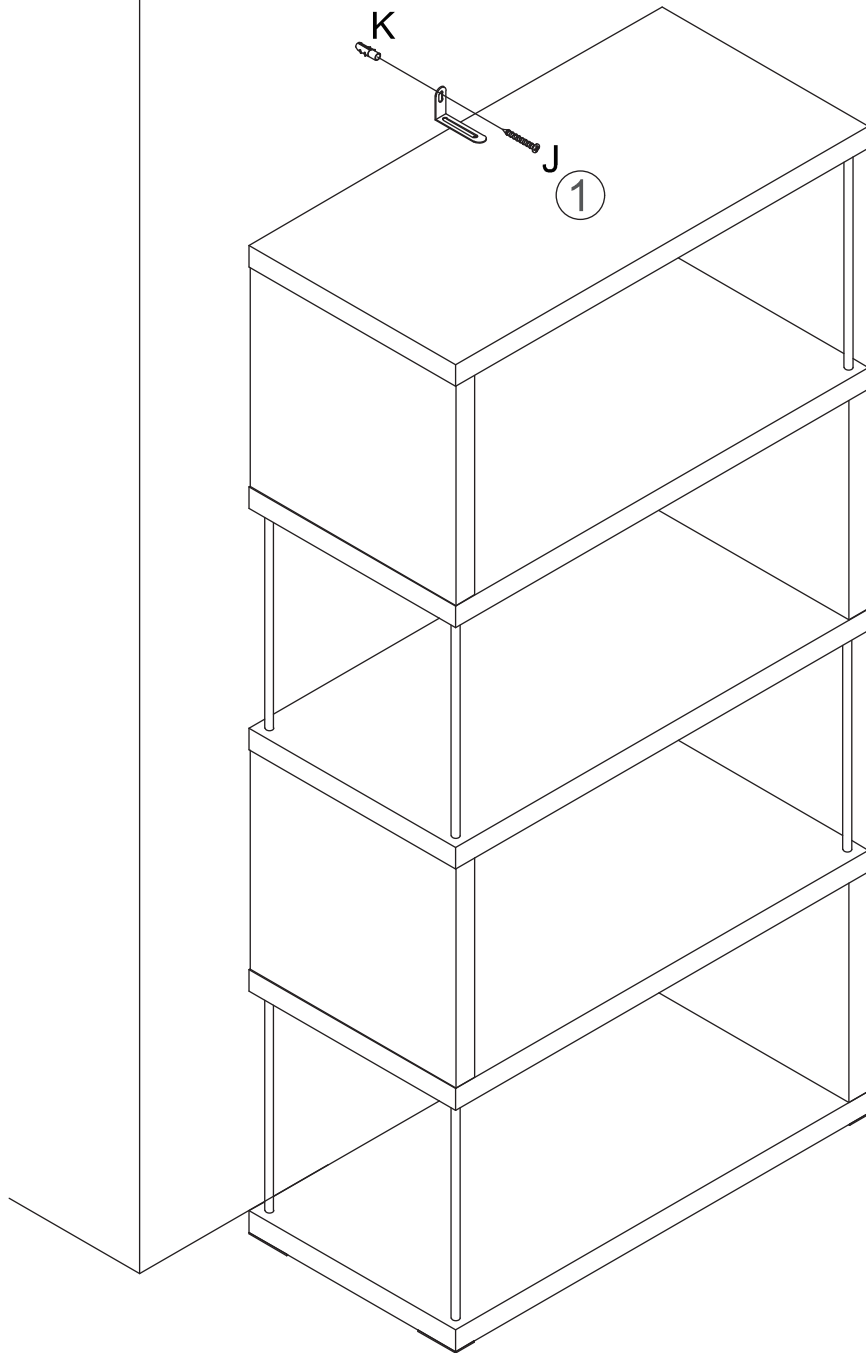
12



J	x1
	
D4x32mm	

K	x1
	
Ø6x30mm	