

UNIT 2250/2024

01	1144x506x16	1/1
----	-------------	-----

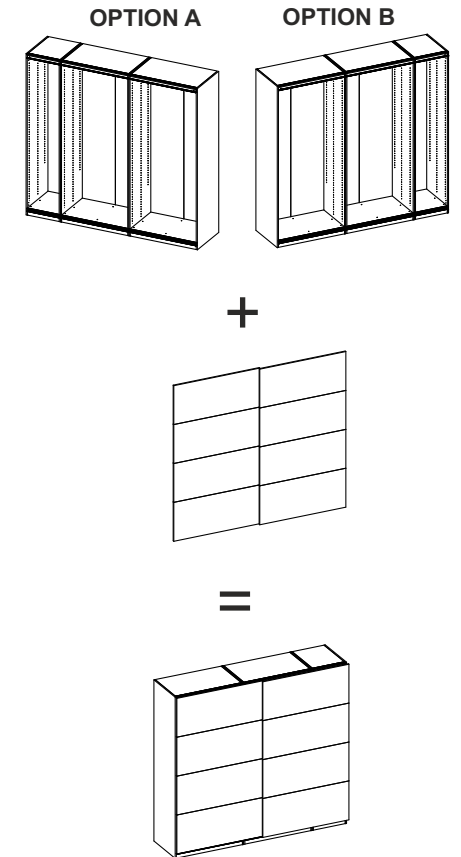
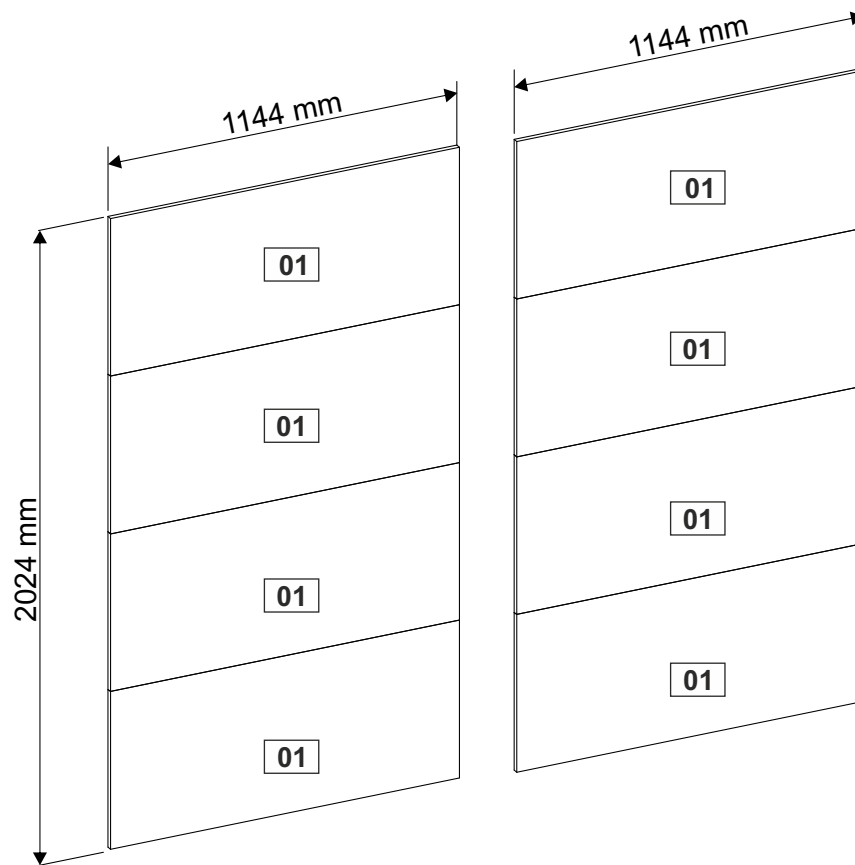
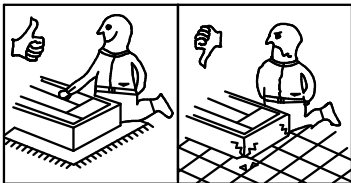
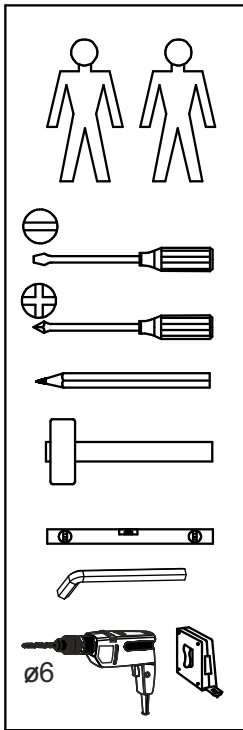

UNIT 2250/2346

C 1/1

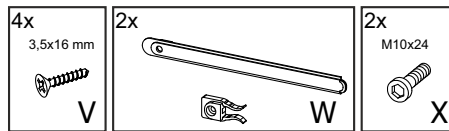
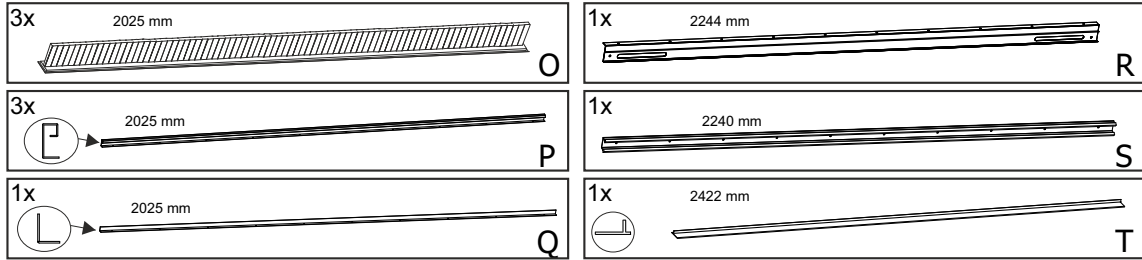
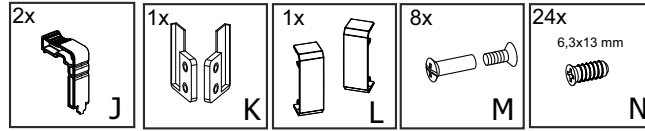
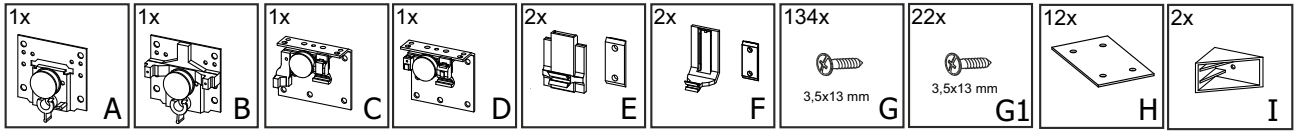
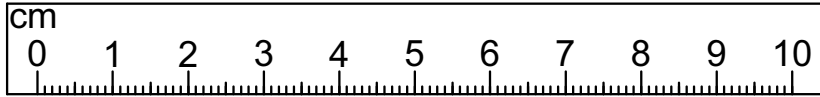

1

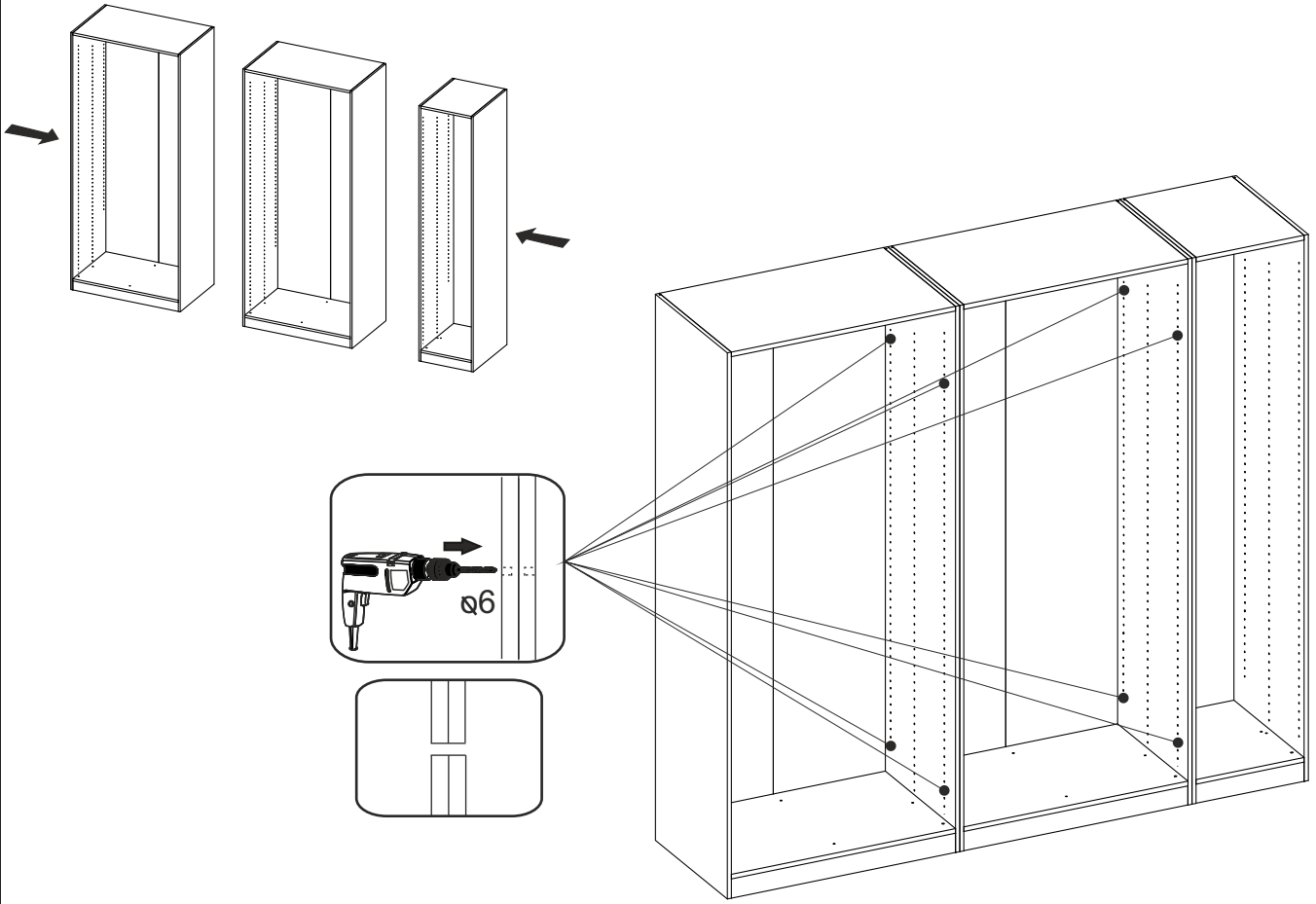

2

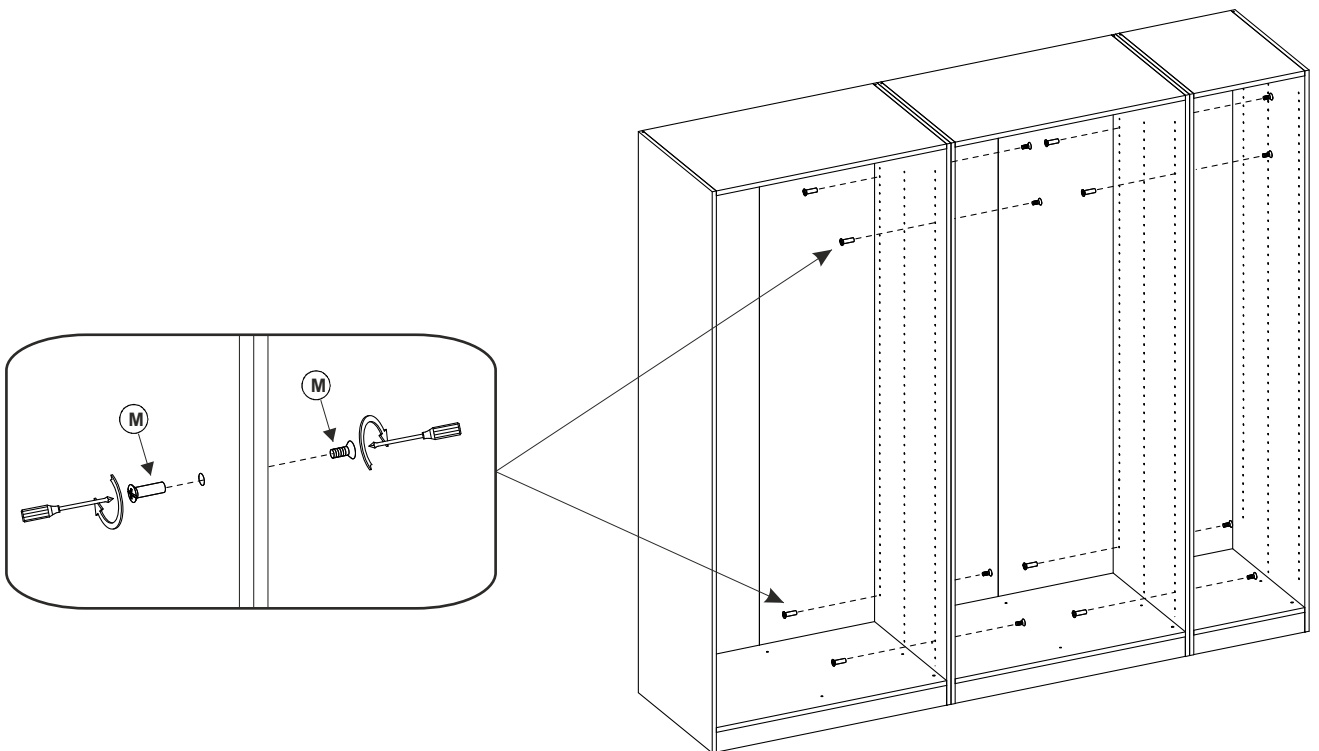
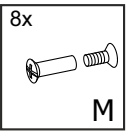

UNIT 2250/2346

3

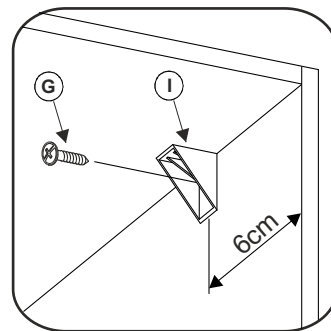
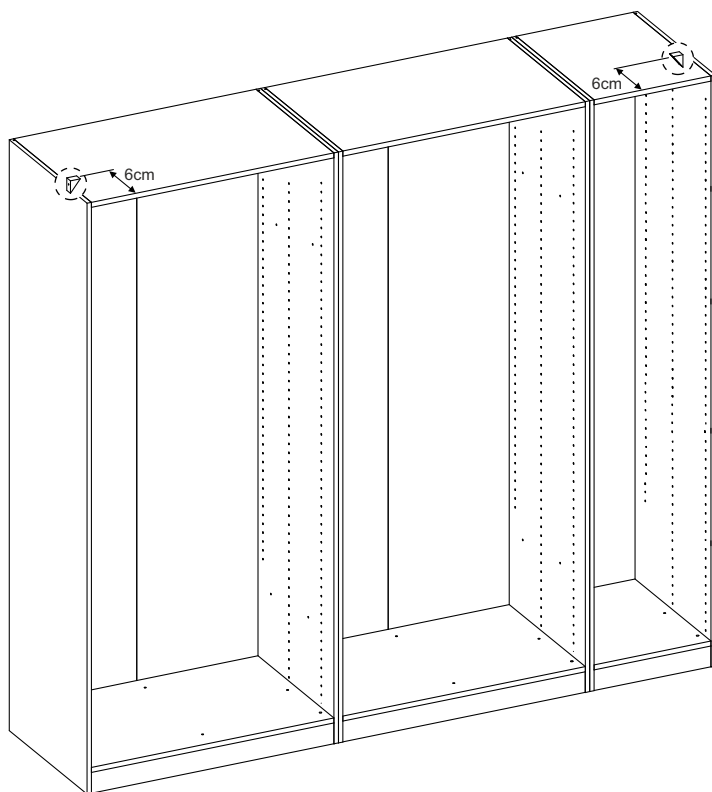
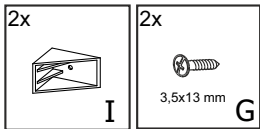

4

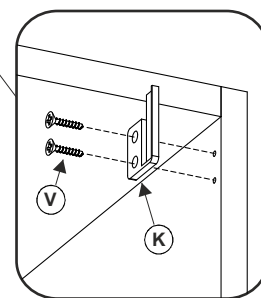
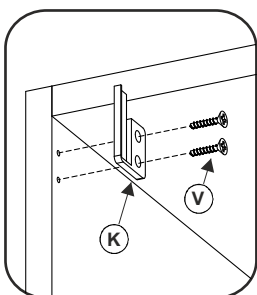
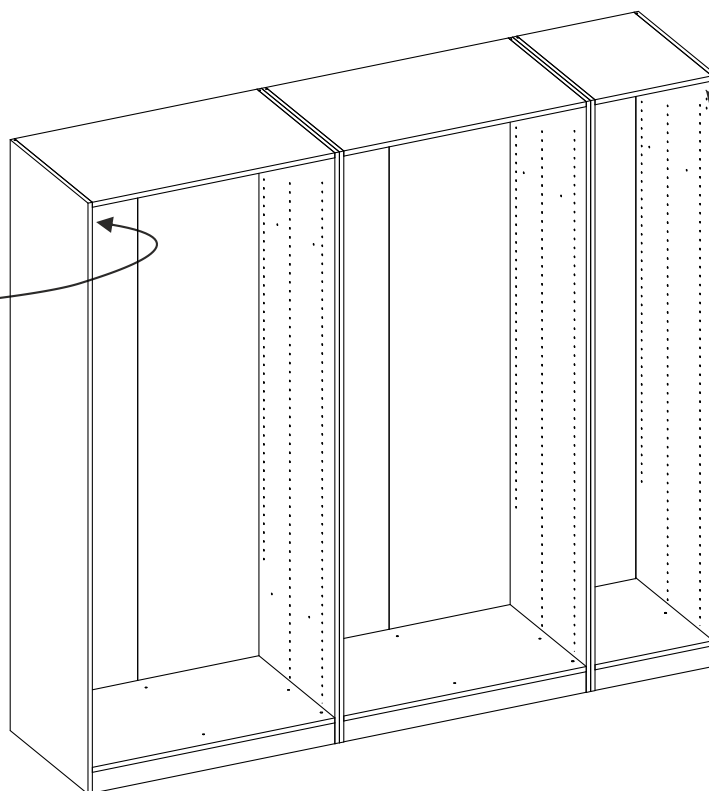
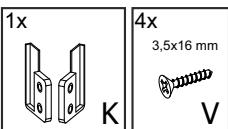

UNIT 2250/2346

5

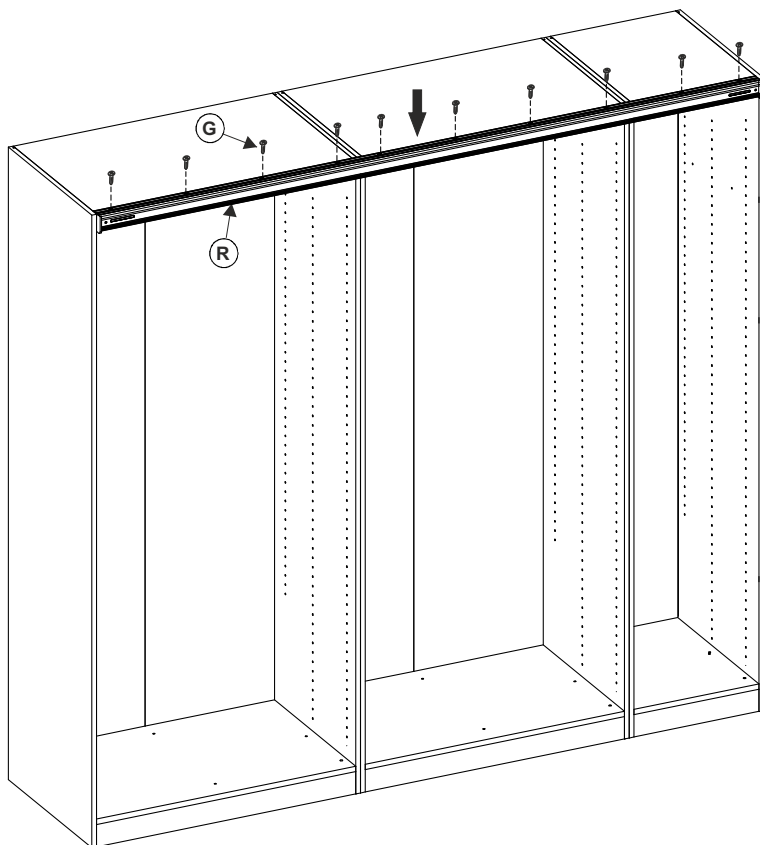
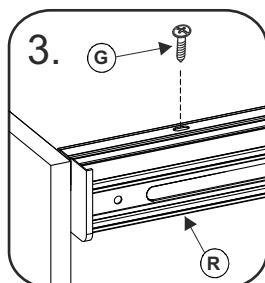
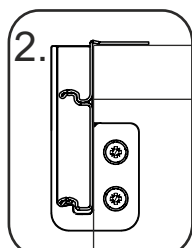
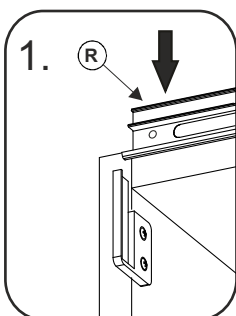
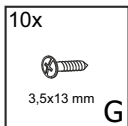

6

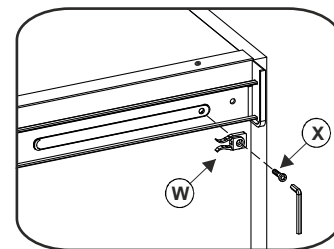
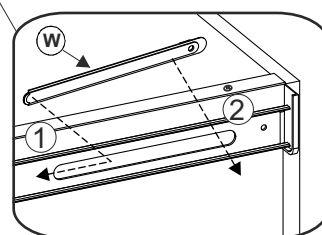
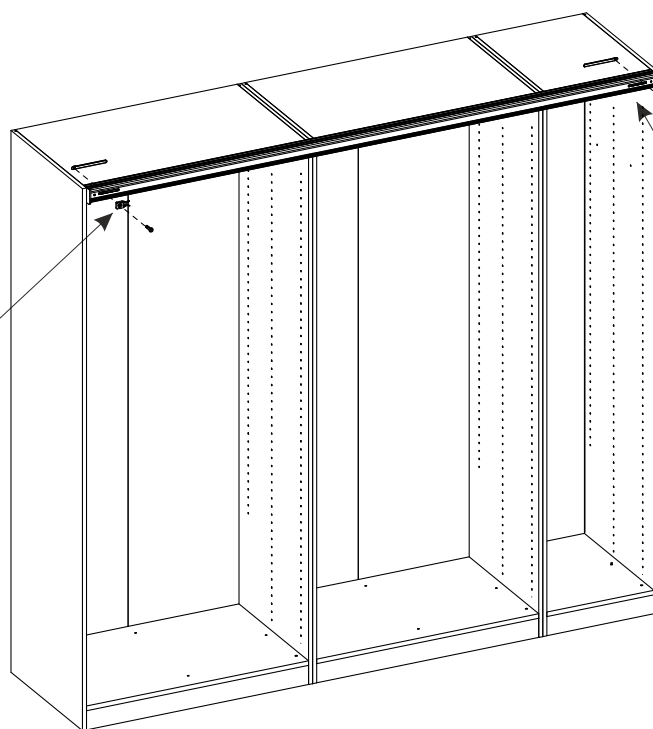
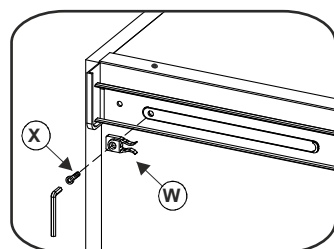
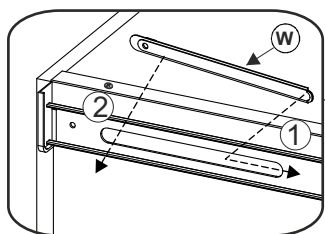
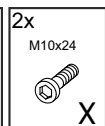
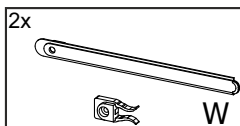

UNIT 2250/2346

7

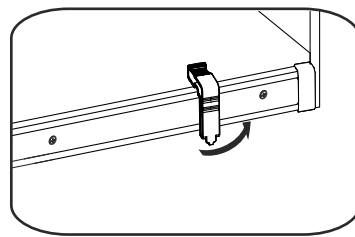
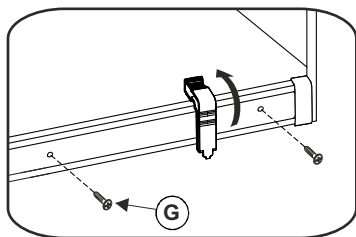
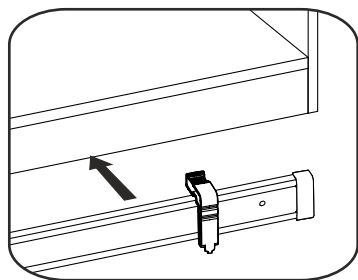
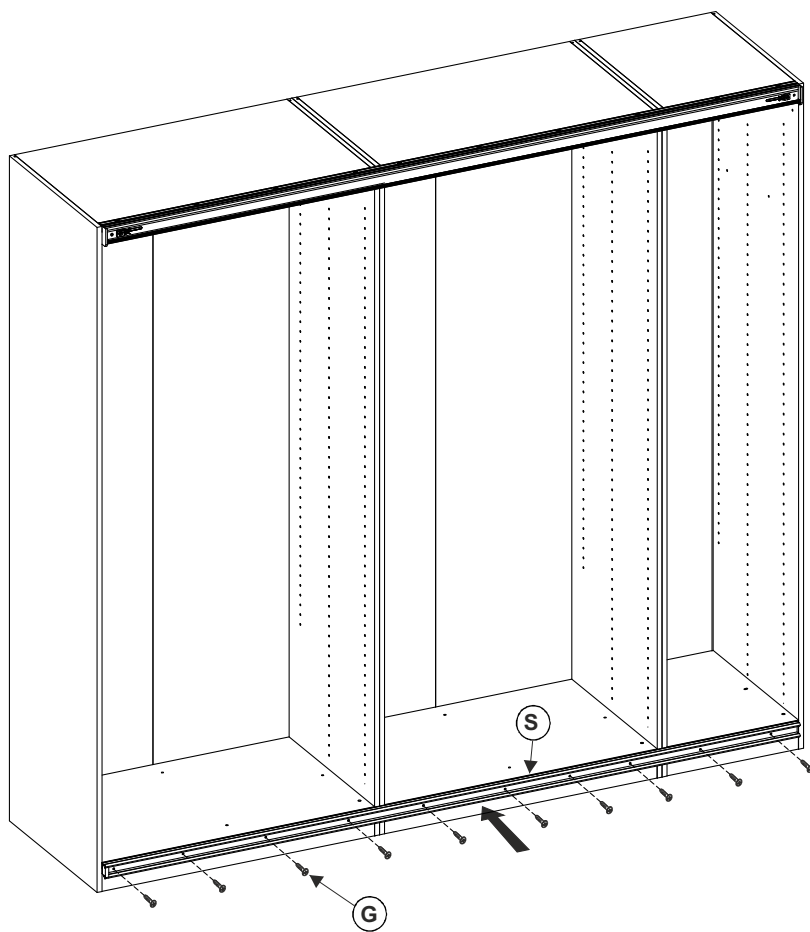
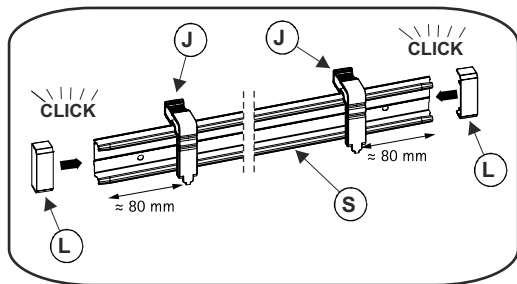
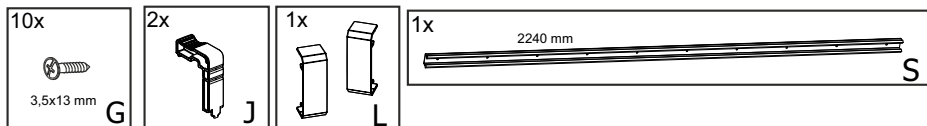

A=B

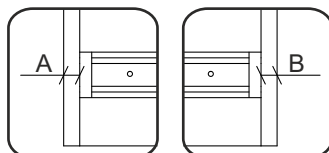

8

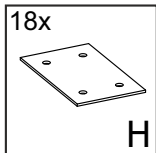
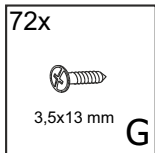
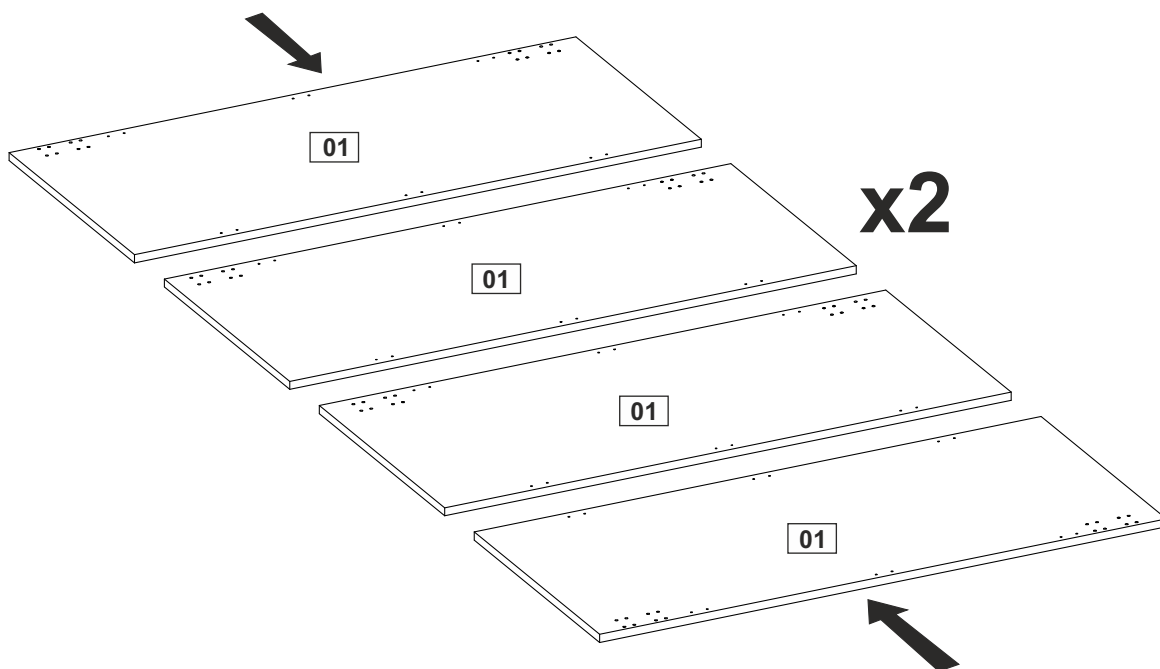
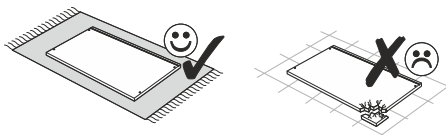

9

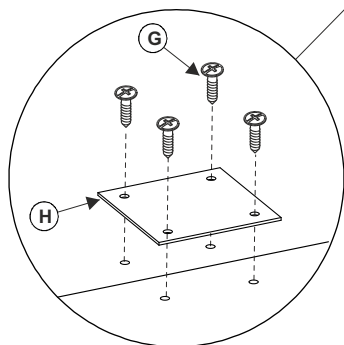
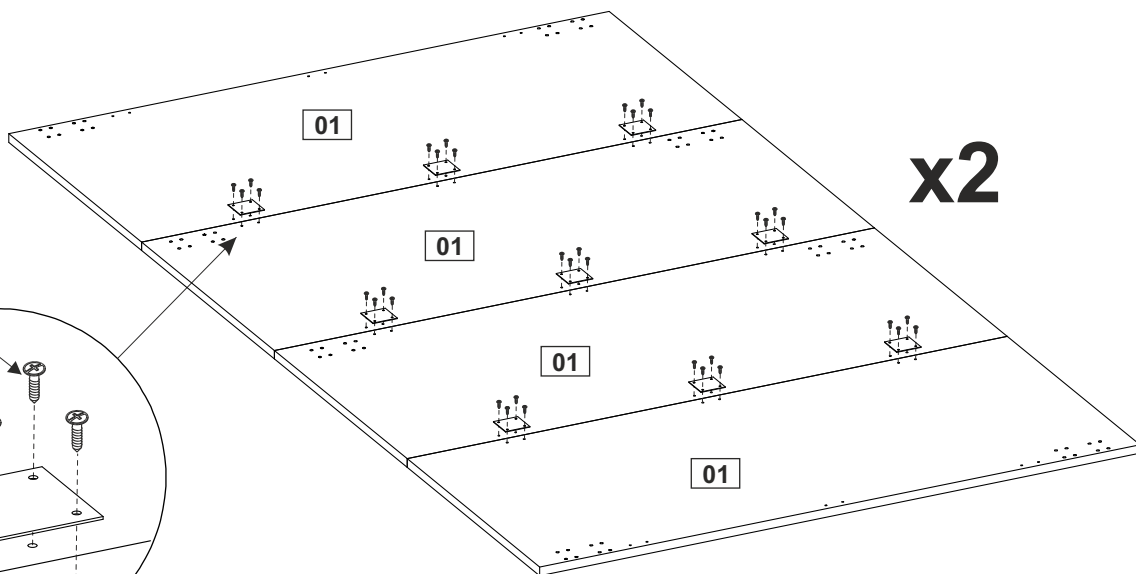
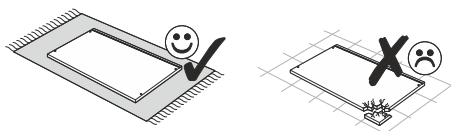

UNIT 2250/2346

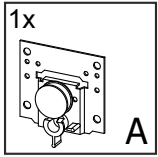
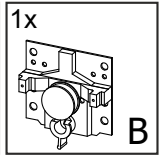
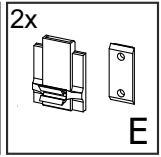
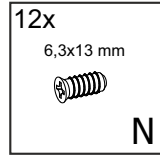
- 1x  A
- 1x  B
- 2x  E
- 12x  6,3x13 mm N

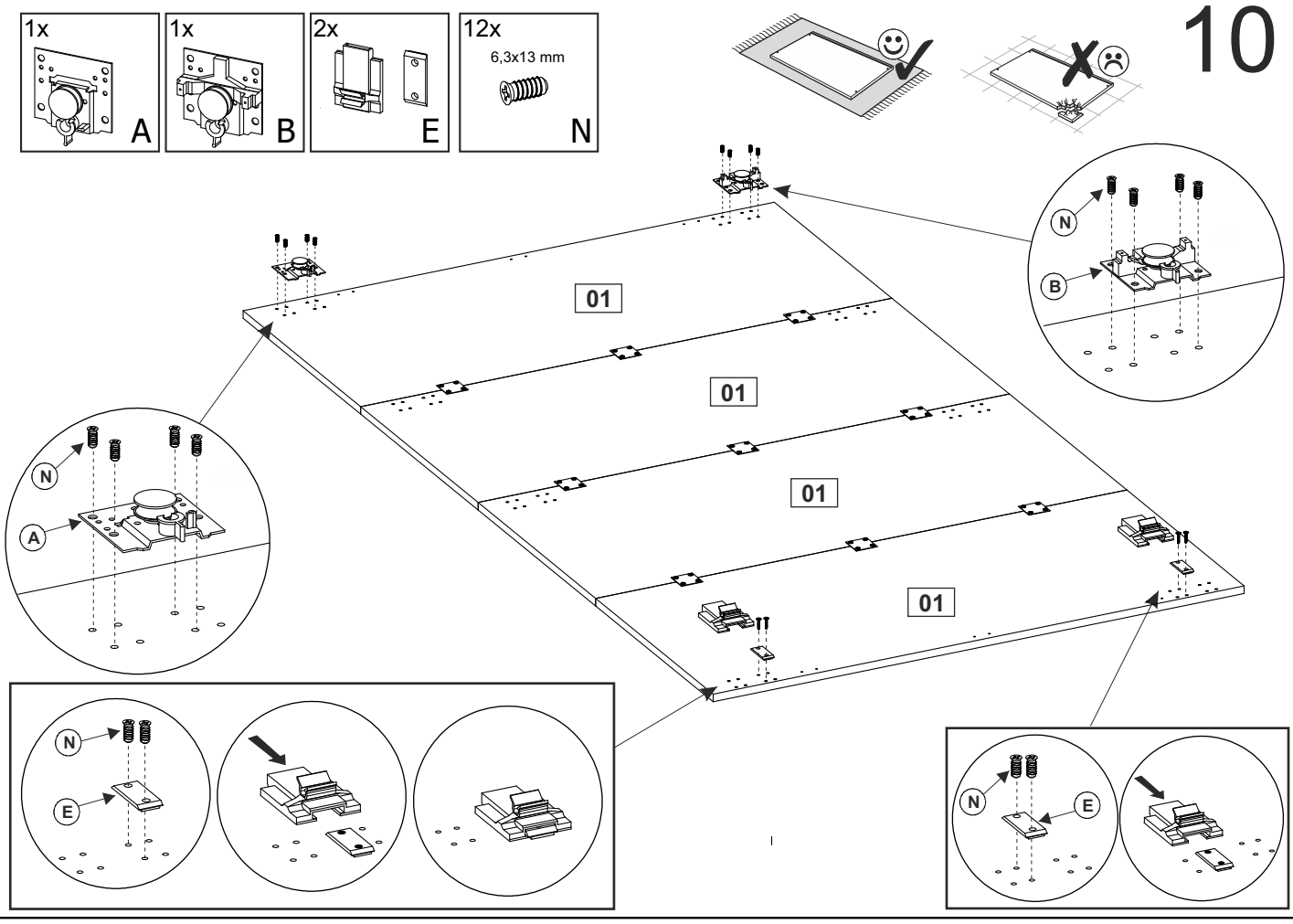

10

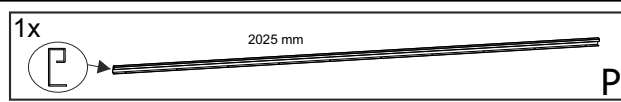
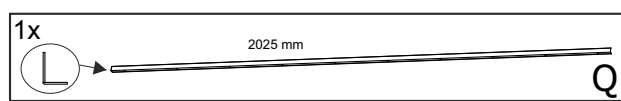
- 1x  2025 mm P
- 1x  2025 mm Q

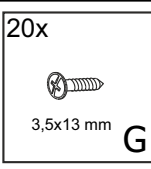
- 20x  3,5x13 mm G

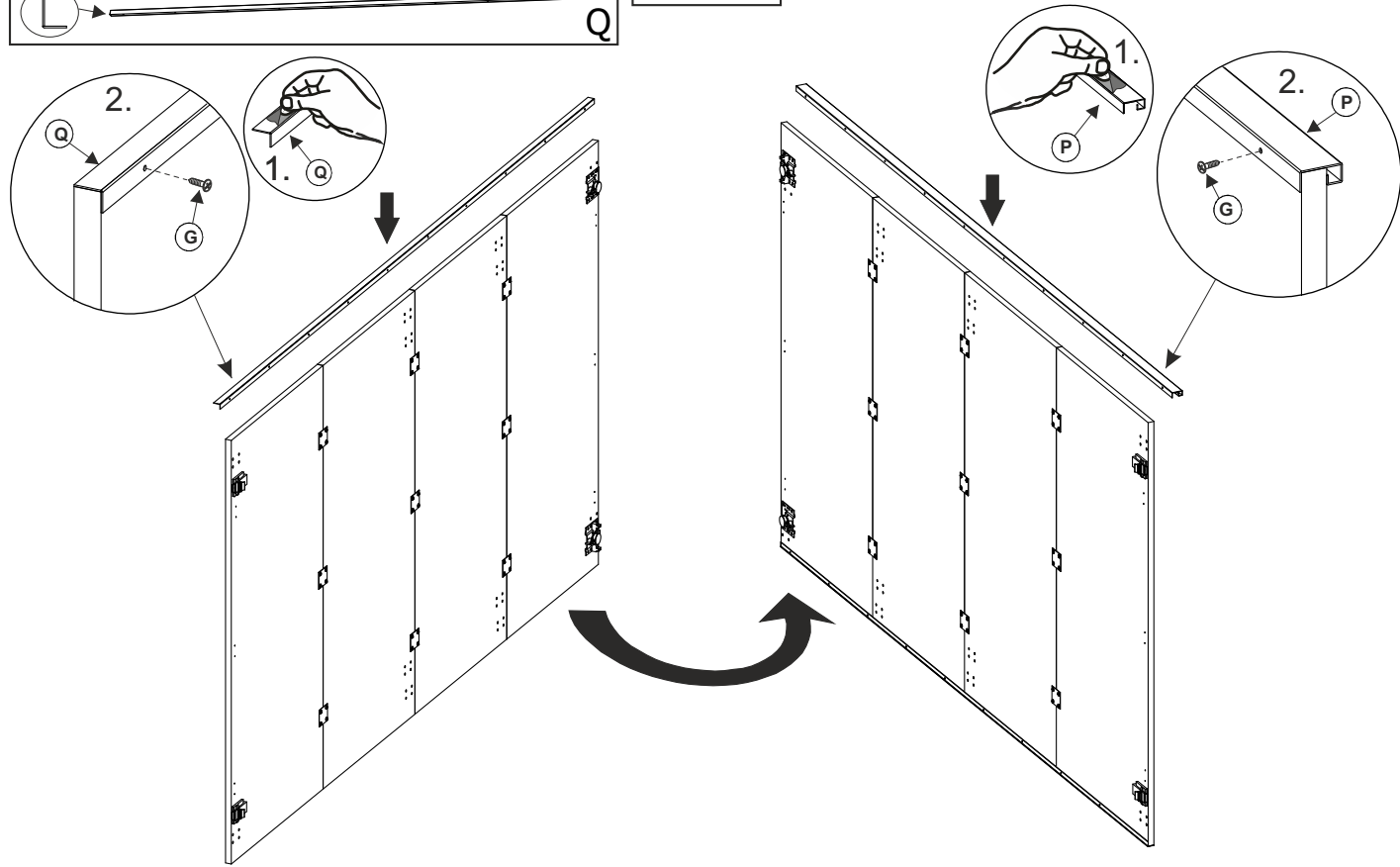

11

UNIT 2250/2346

1x 2025 mm 0

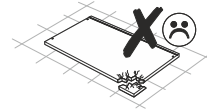
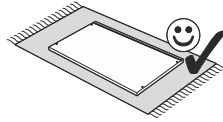

12

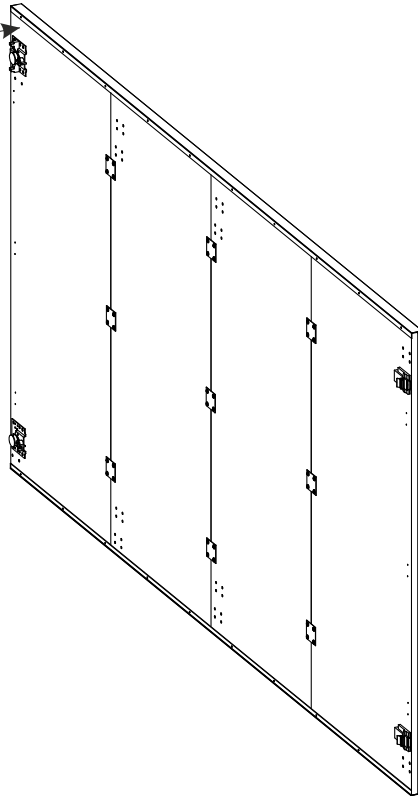
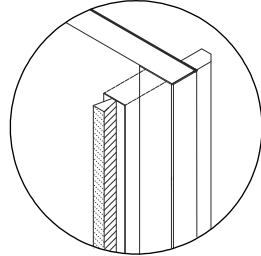
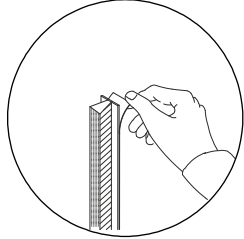
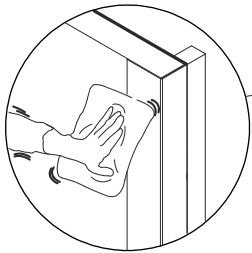

13

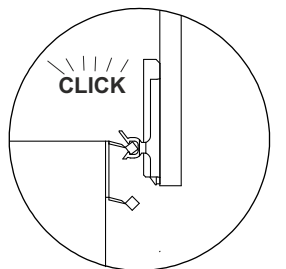
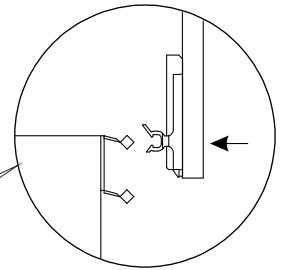
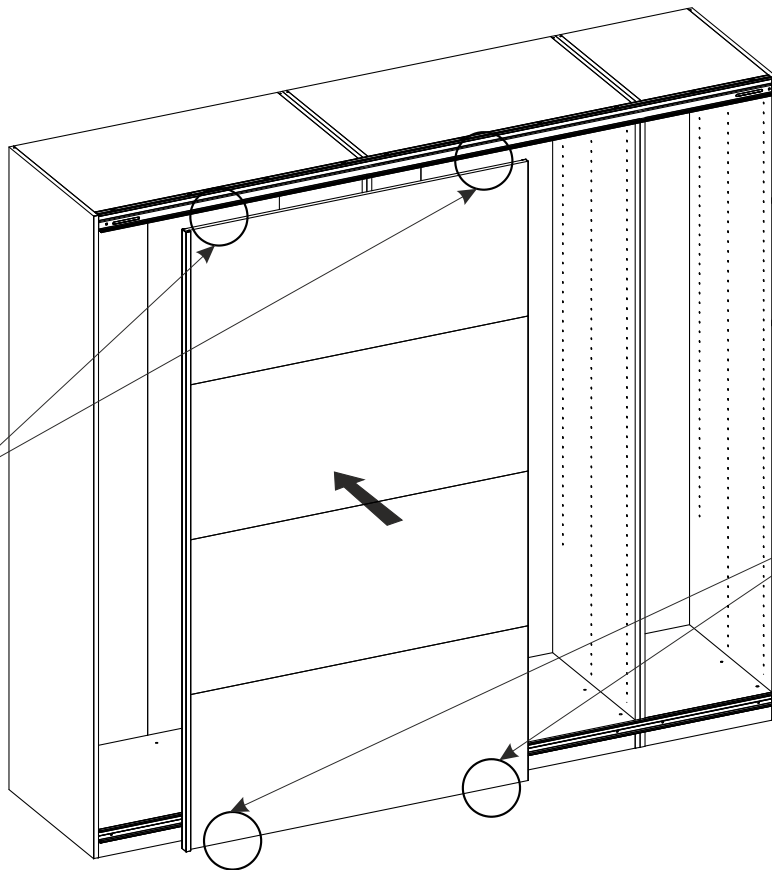
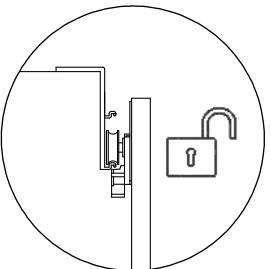
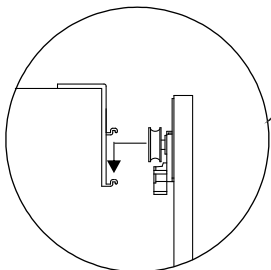

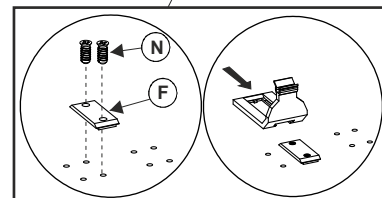
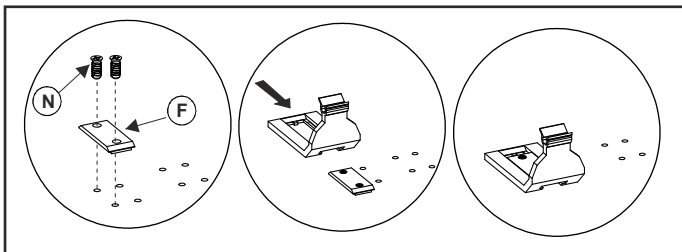
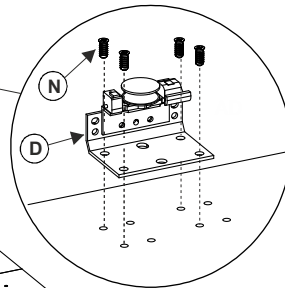
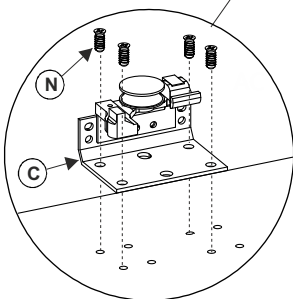
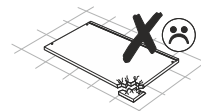
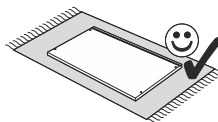
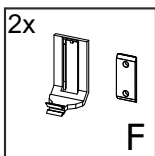
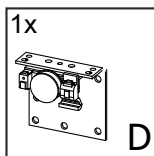
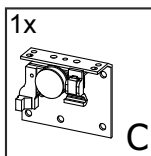
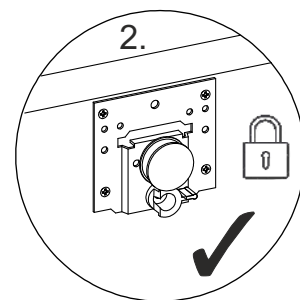
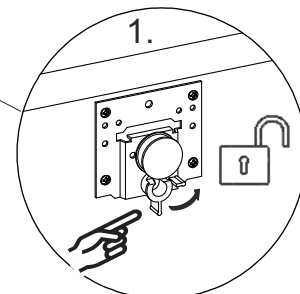
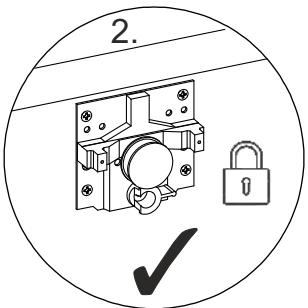
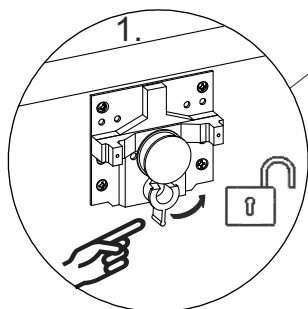
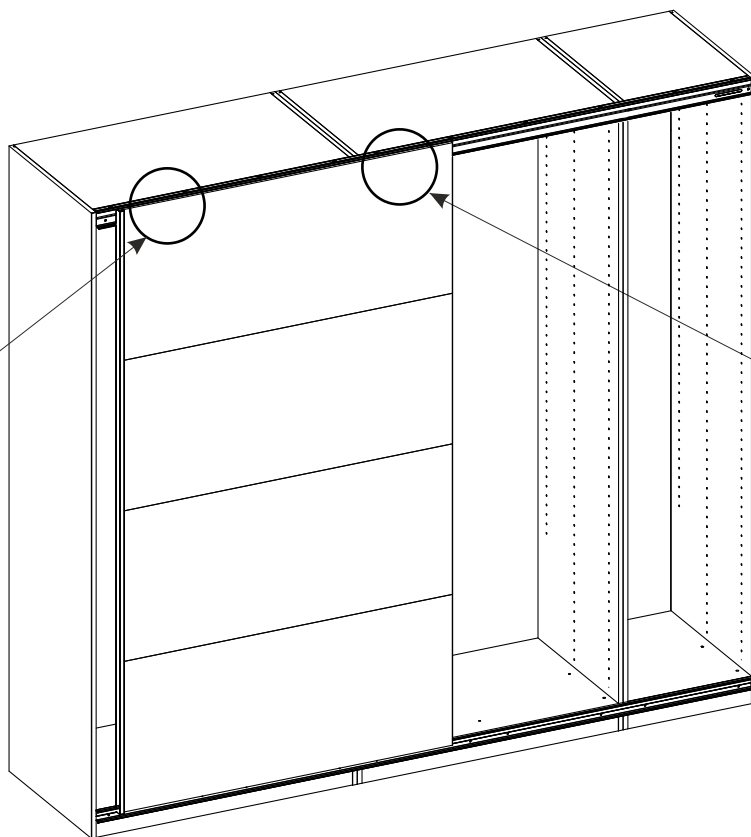

UNIT 2250/2346

16

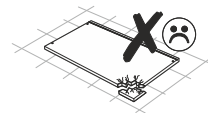
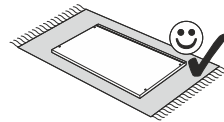
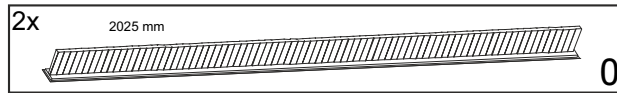
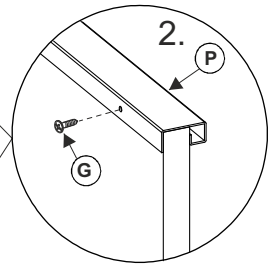
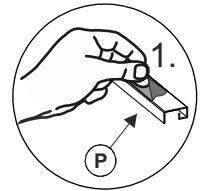
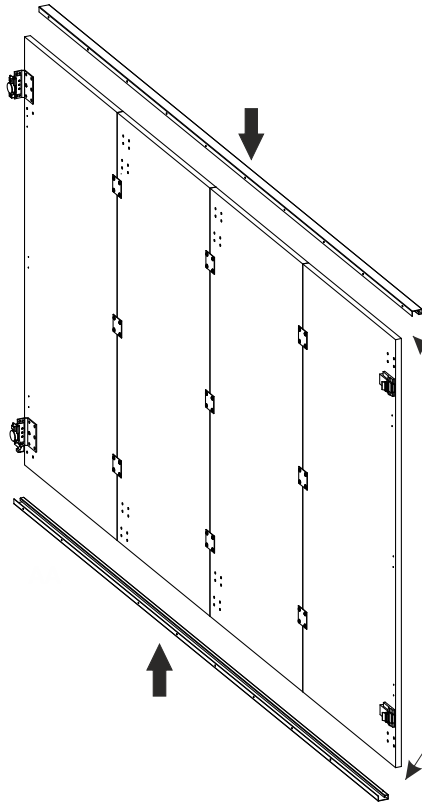
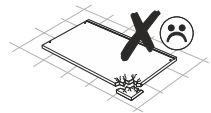
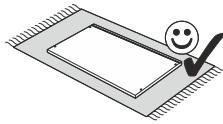
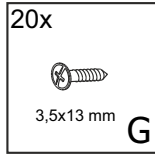

17

