

Nr	Ausmaß			St	Colli
1	754	361	15	1	1
2	754	341	15	1	1
3	754	341	15	1	1
4	754	361	15	1	1
5	1198	380	15	1	2
6	376	330	15	2	1
7	1198	362	15	1	2
8	396	764	15	1	2
9	396	380	15	1	2
10	396	764	15	1	2
11	396	189	15	2	2
12	300	100	12	2	1
13	300	100	12	2	1
14	345	100	12	2	1
15	299	356	2	2	2
16	768	390	2	2	2
17	768	398	2	1	2

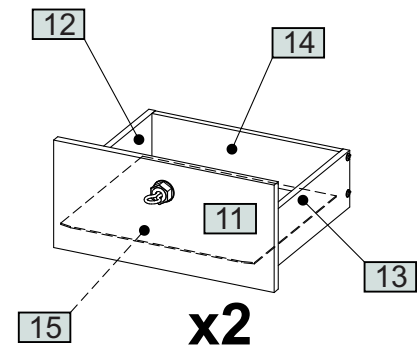

1

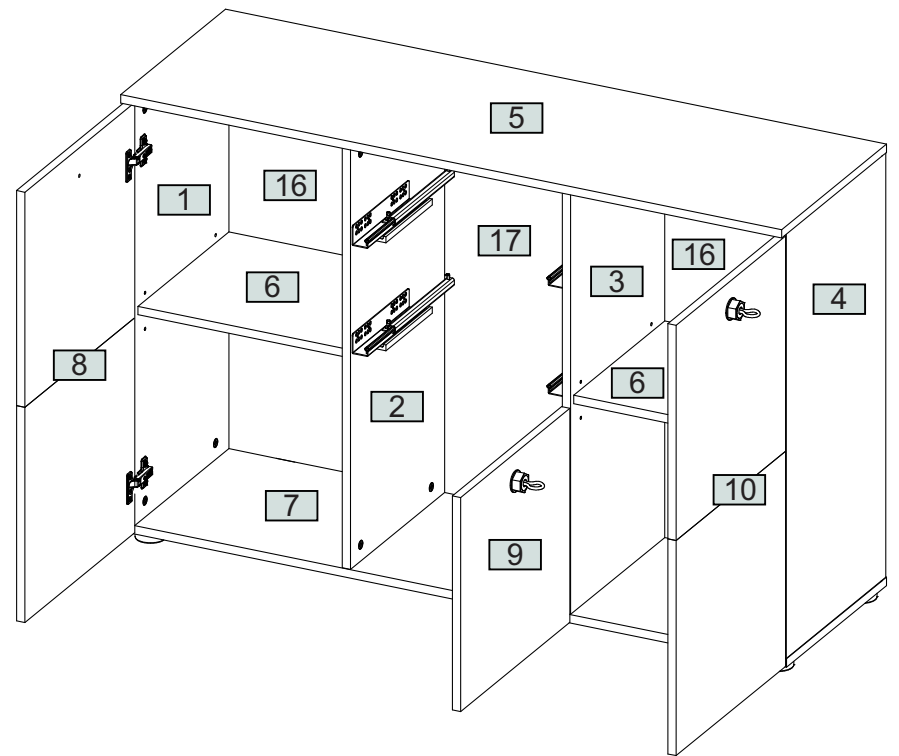
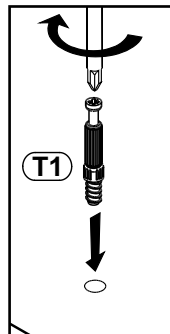
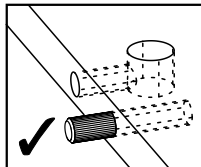
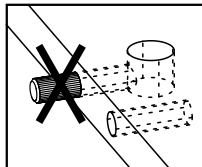
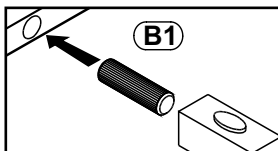
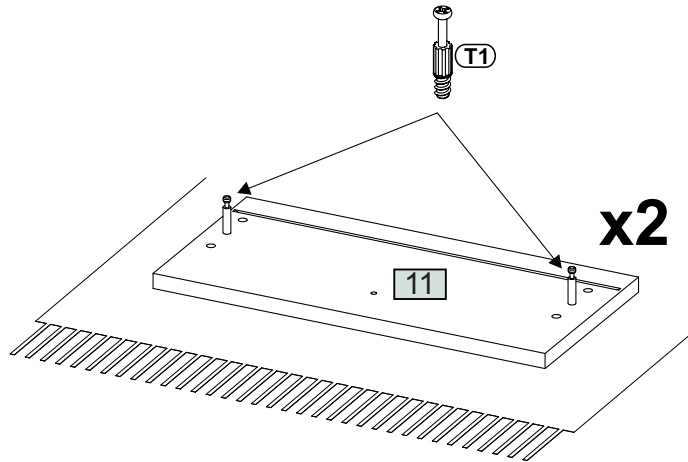
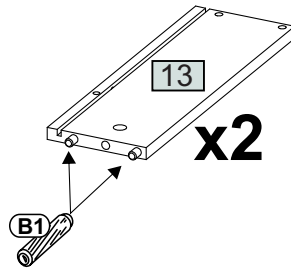
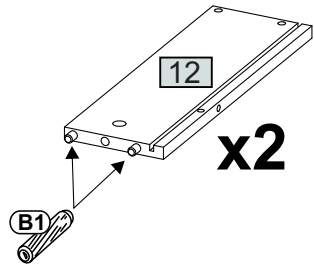
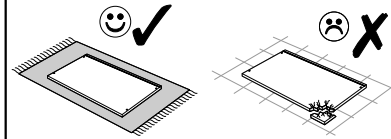
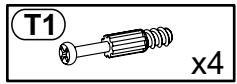
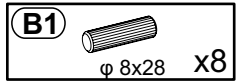

2

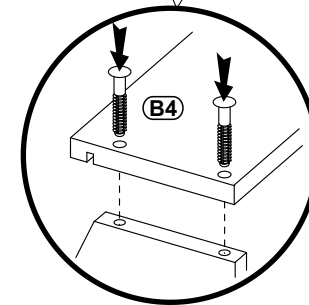
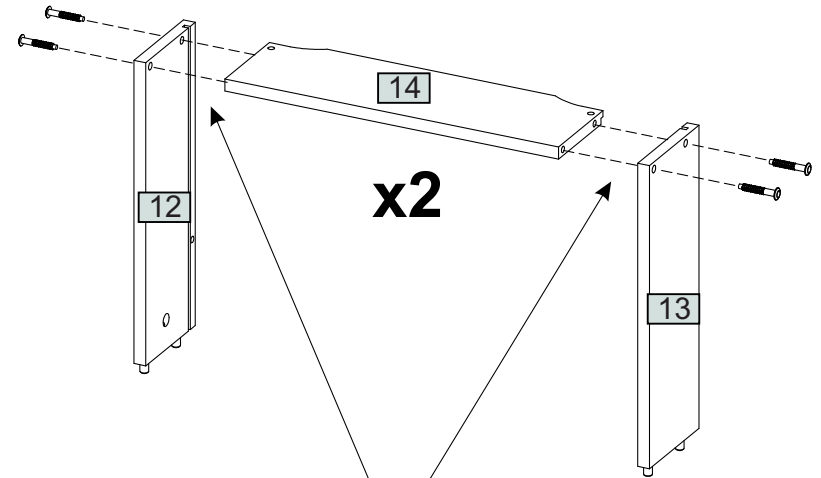
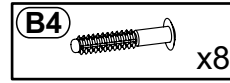

3

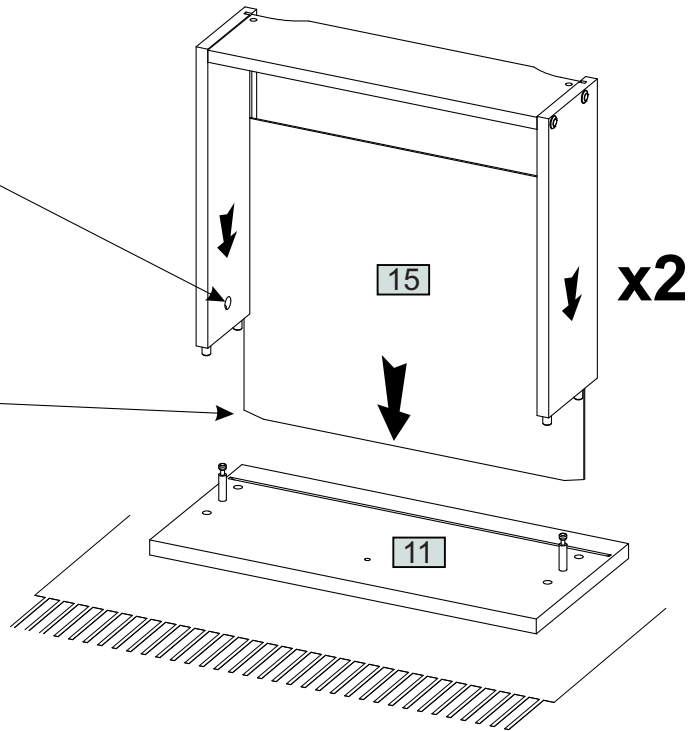
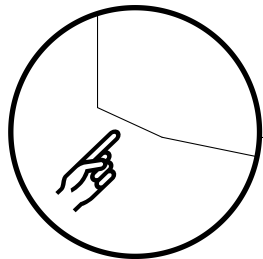
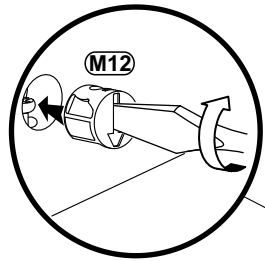
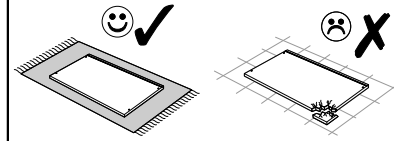

4

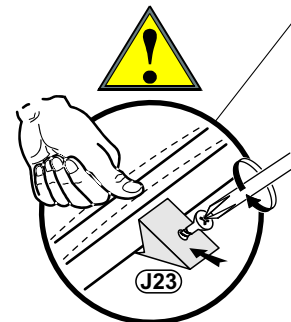
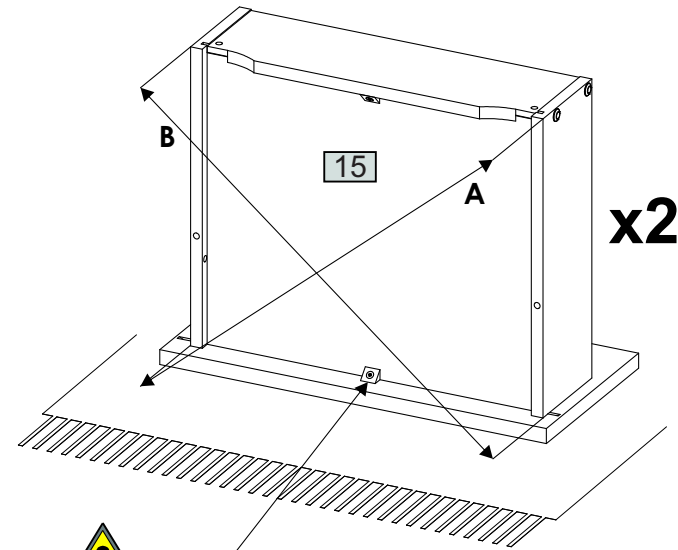
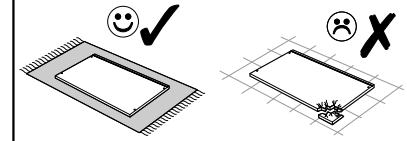
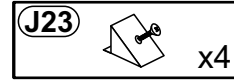

5

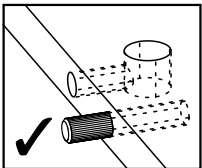
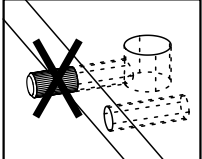
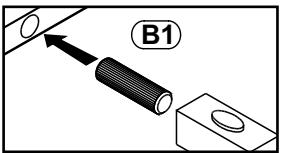
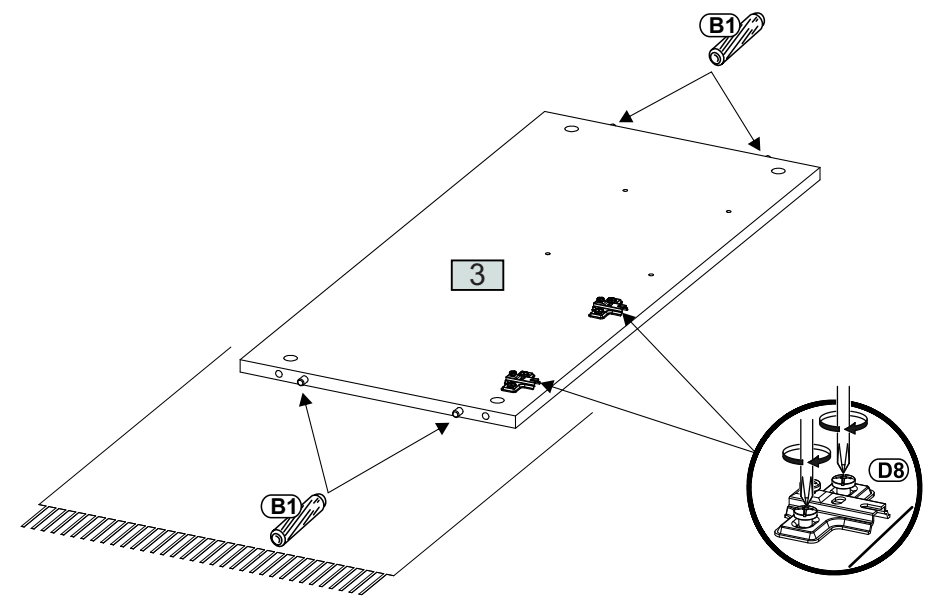
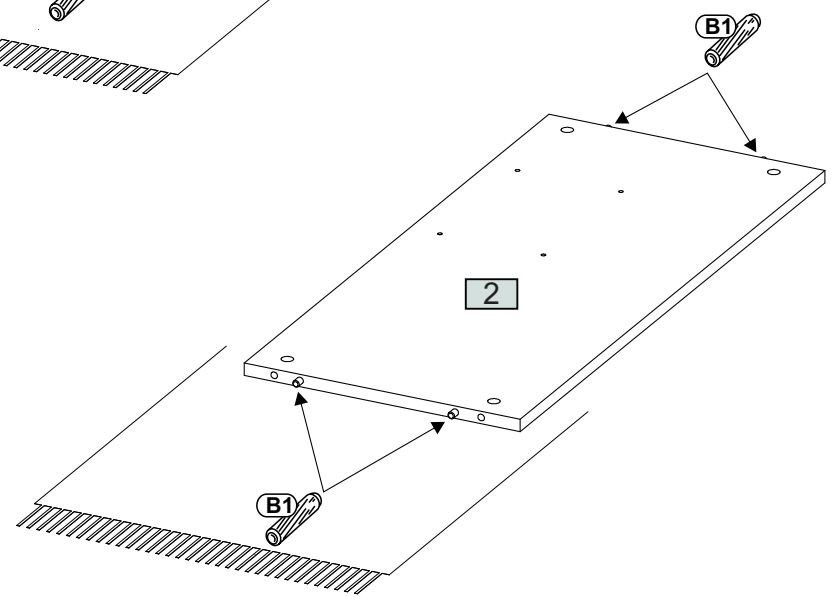
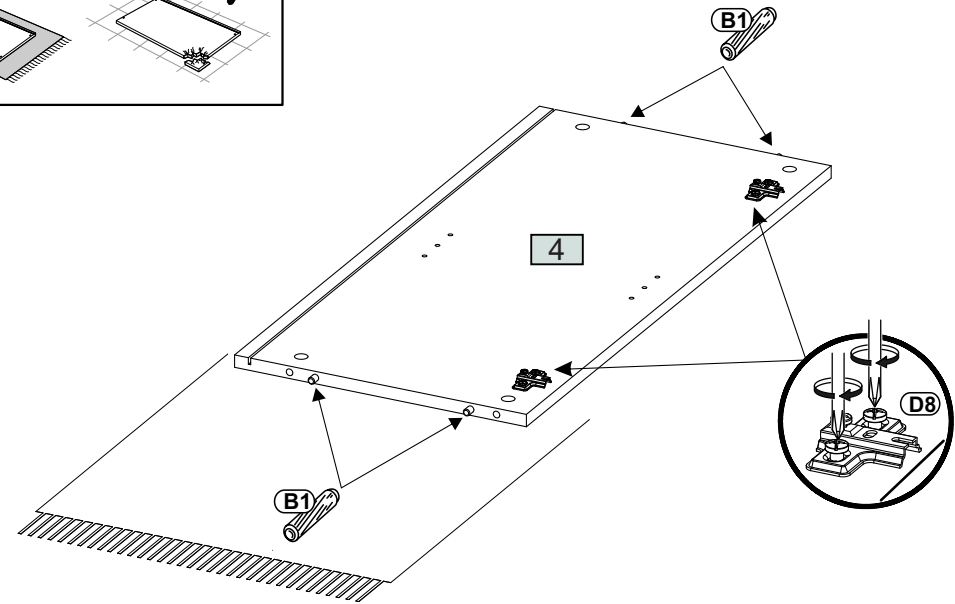
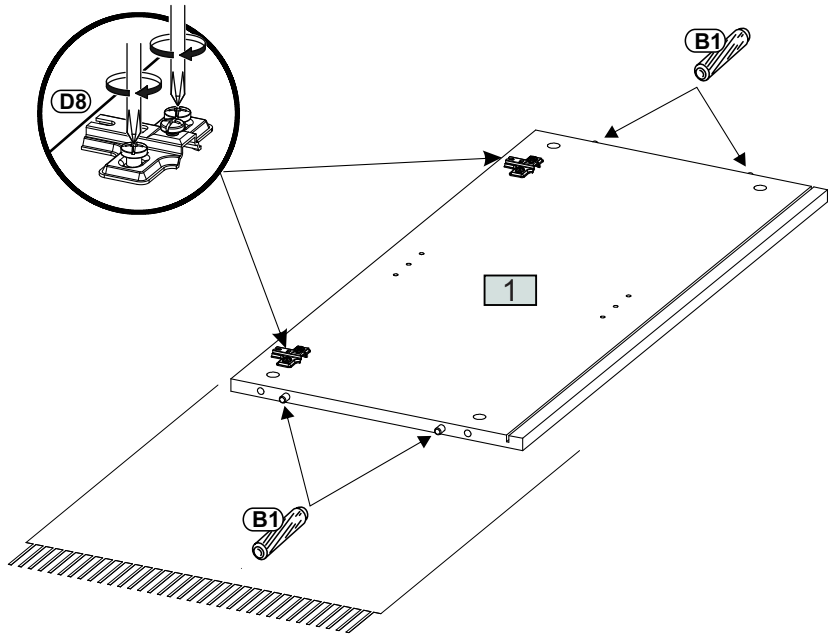
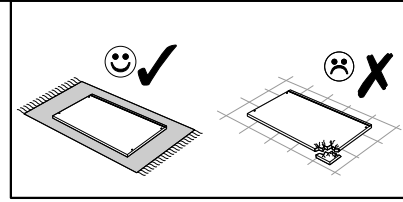
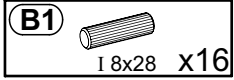
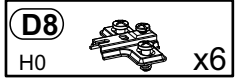

6

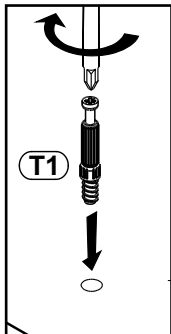
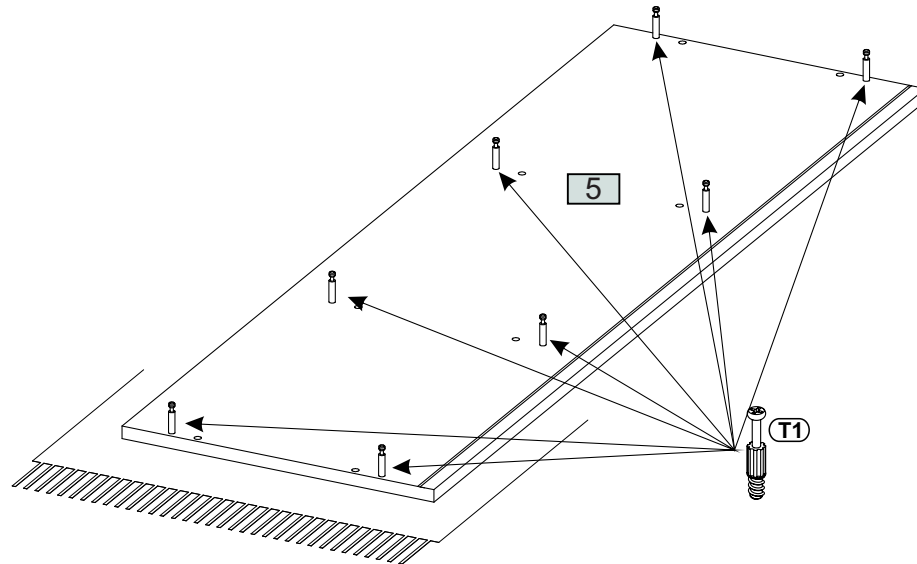
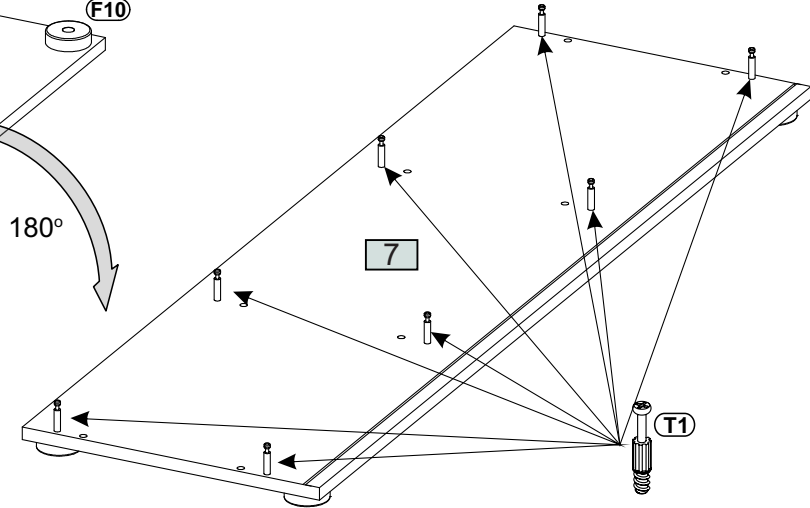
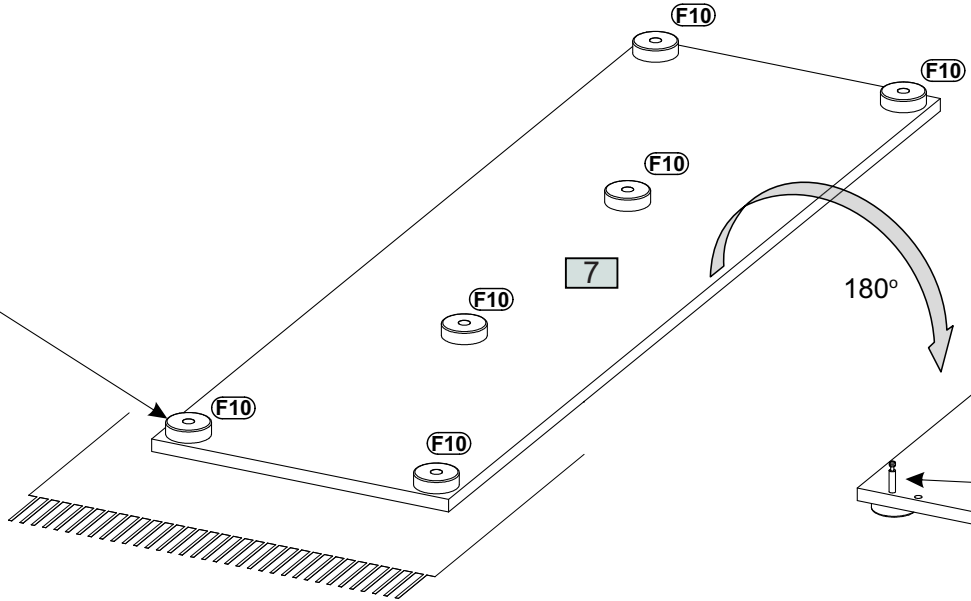
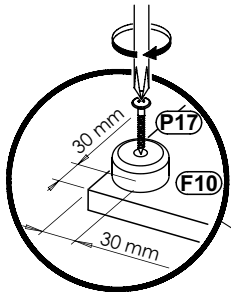
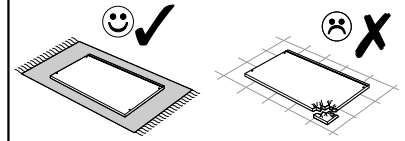
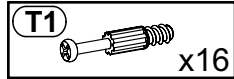
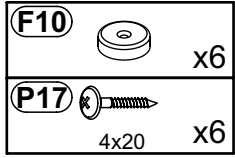

7

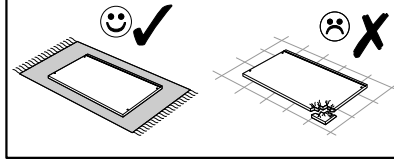
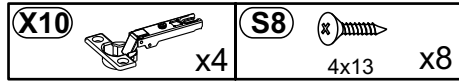

8

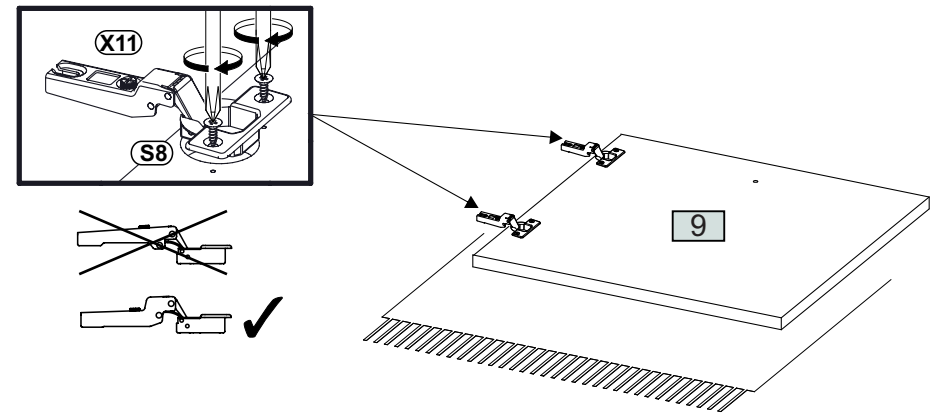
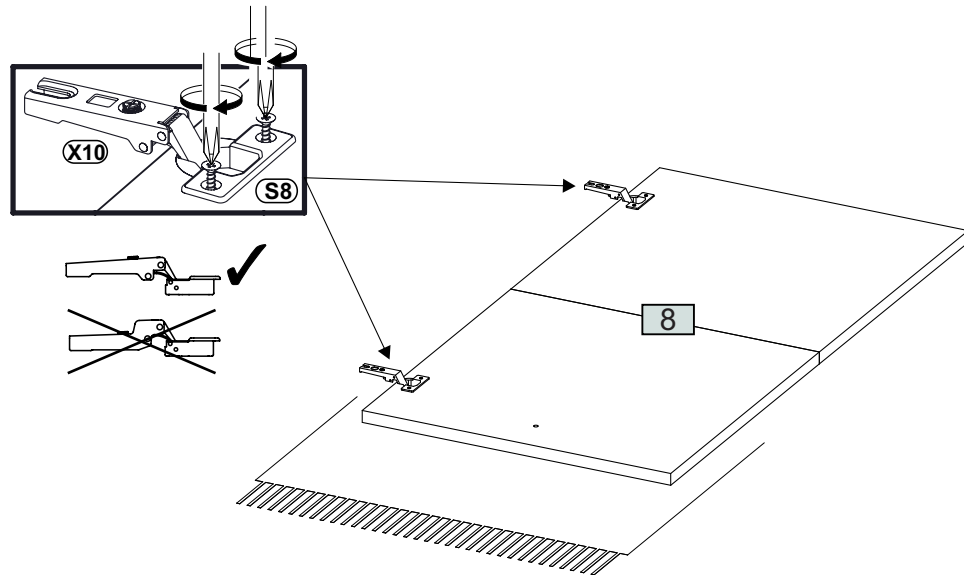
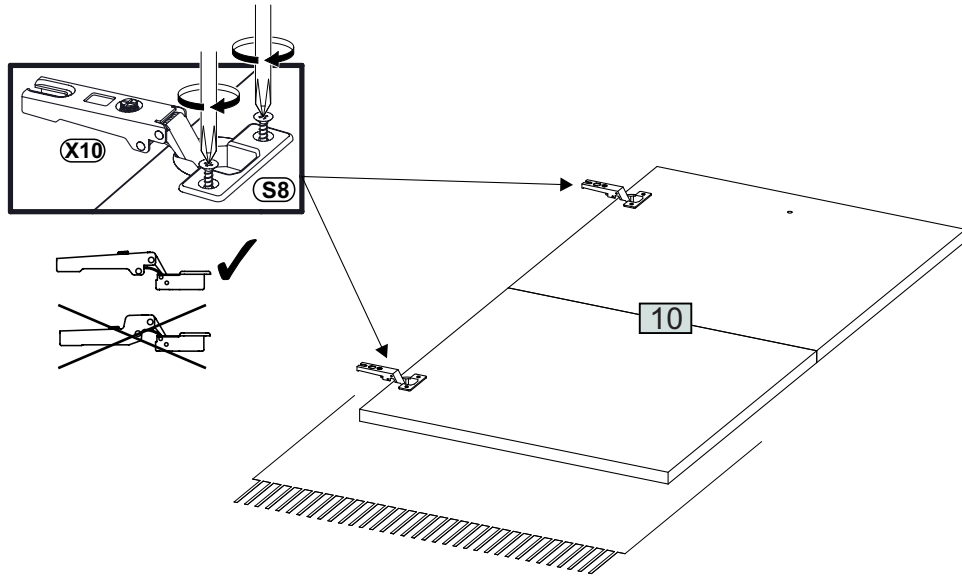
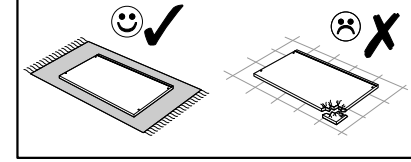
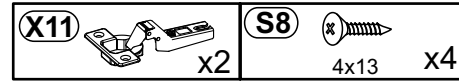

9

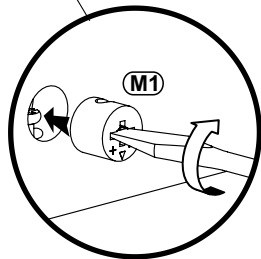
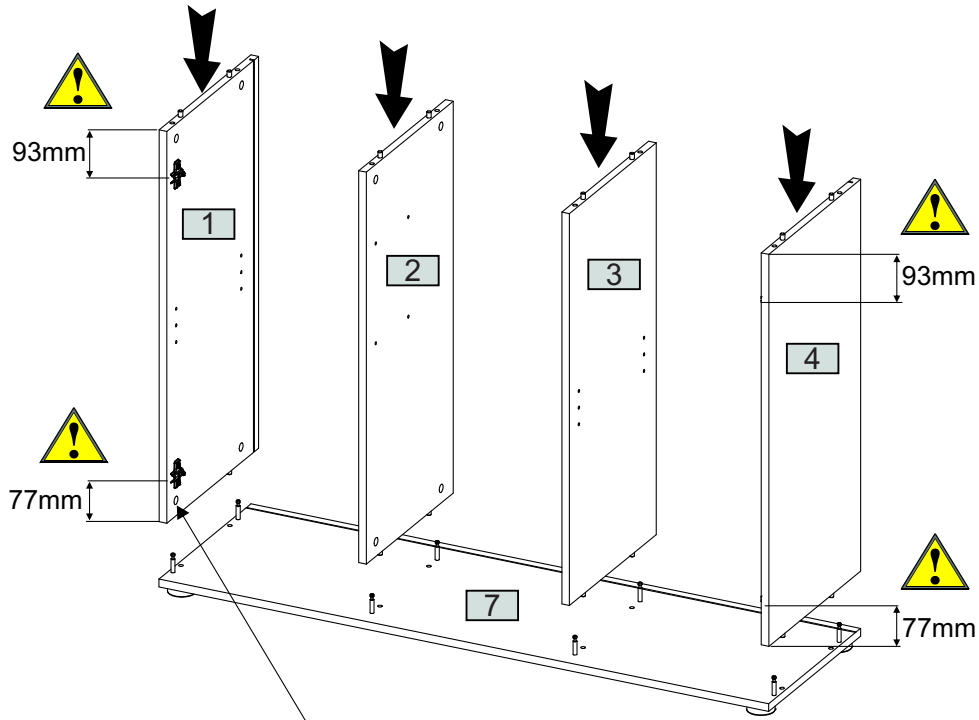

10

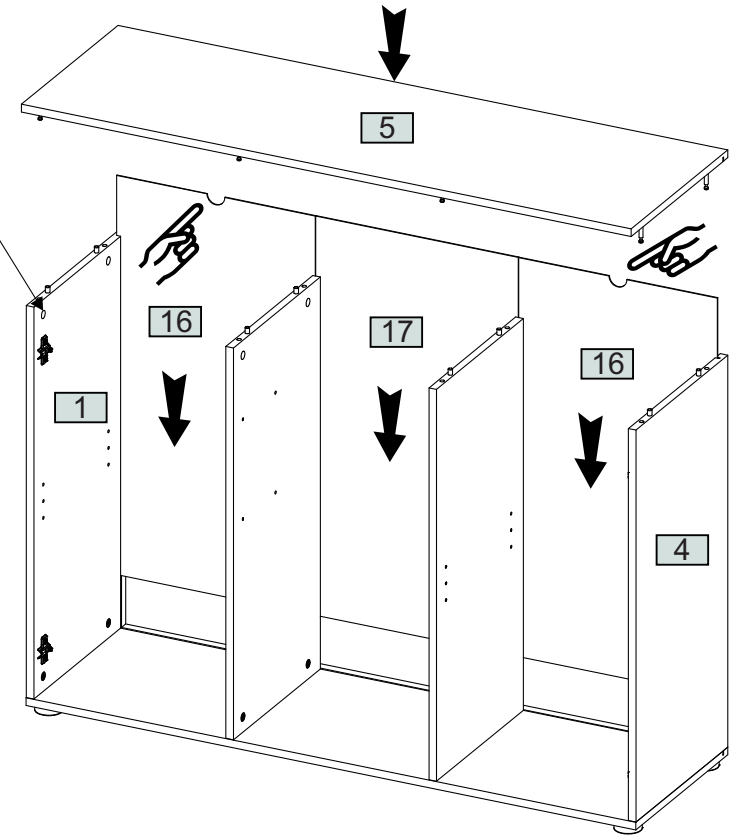
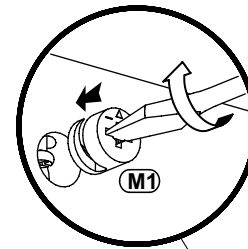





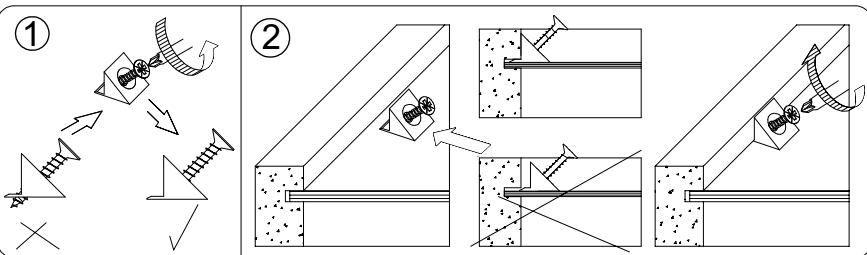
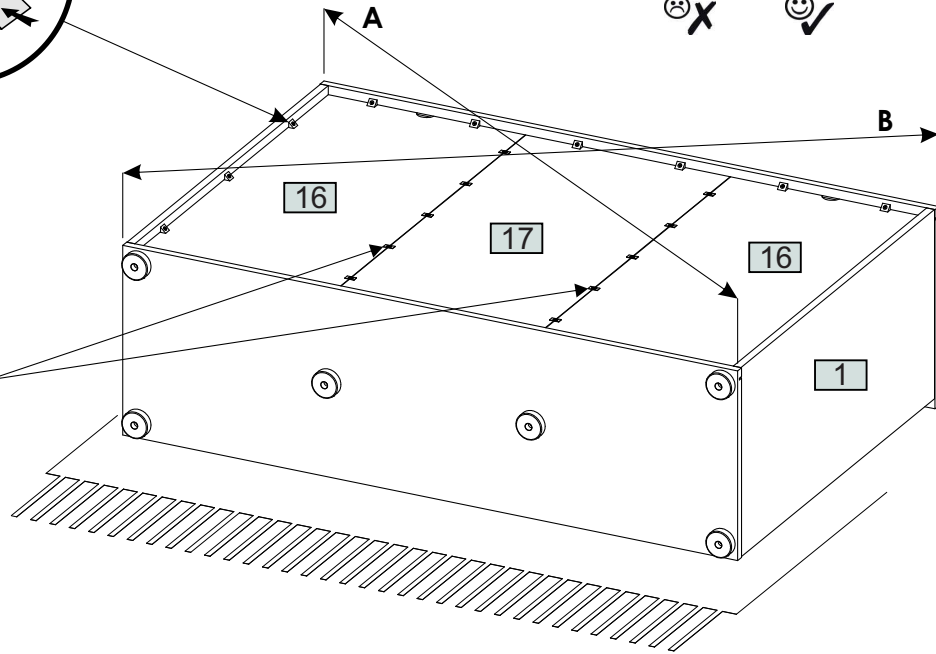
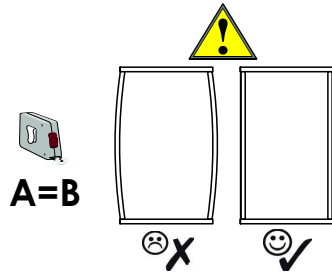
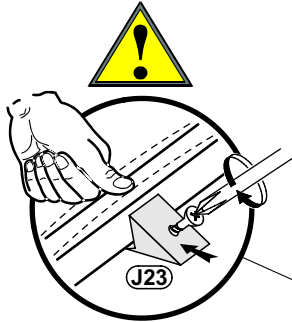
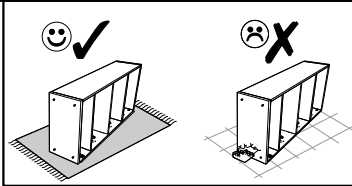
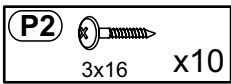
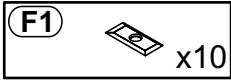
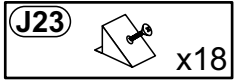

11

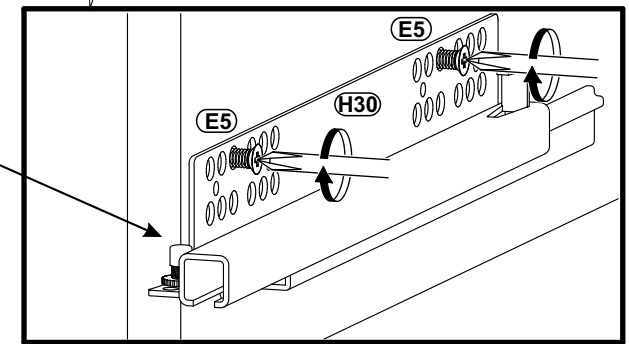
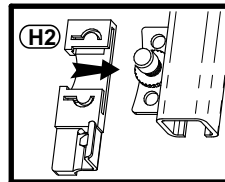
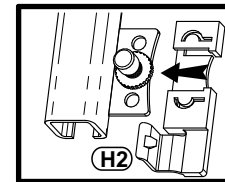
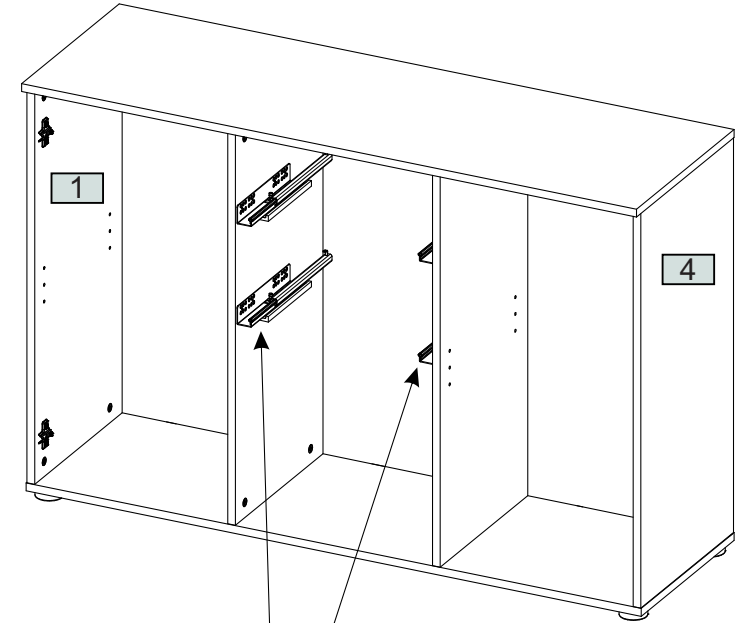
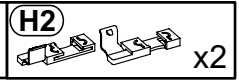
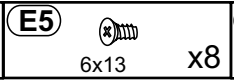
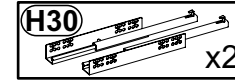

12

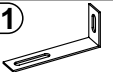

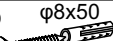
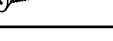

13

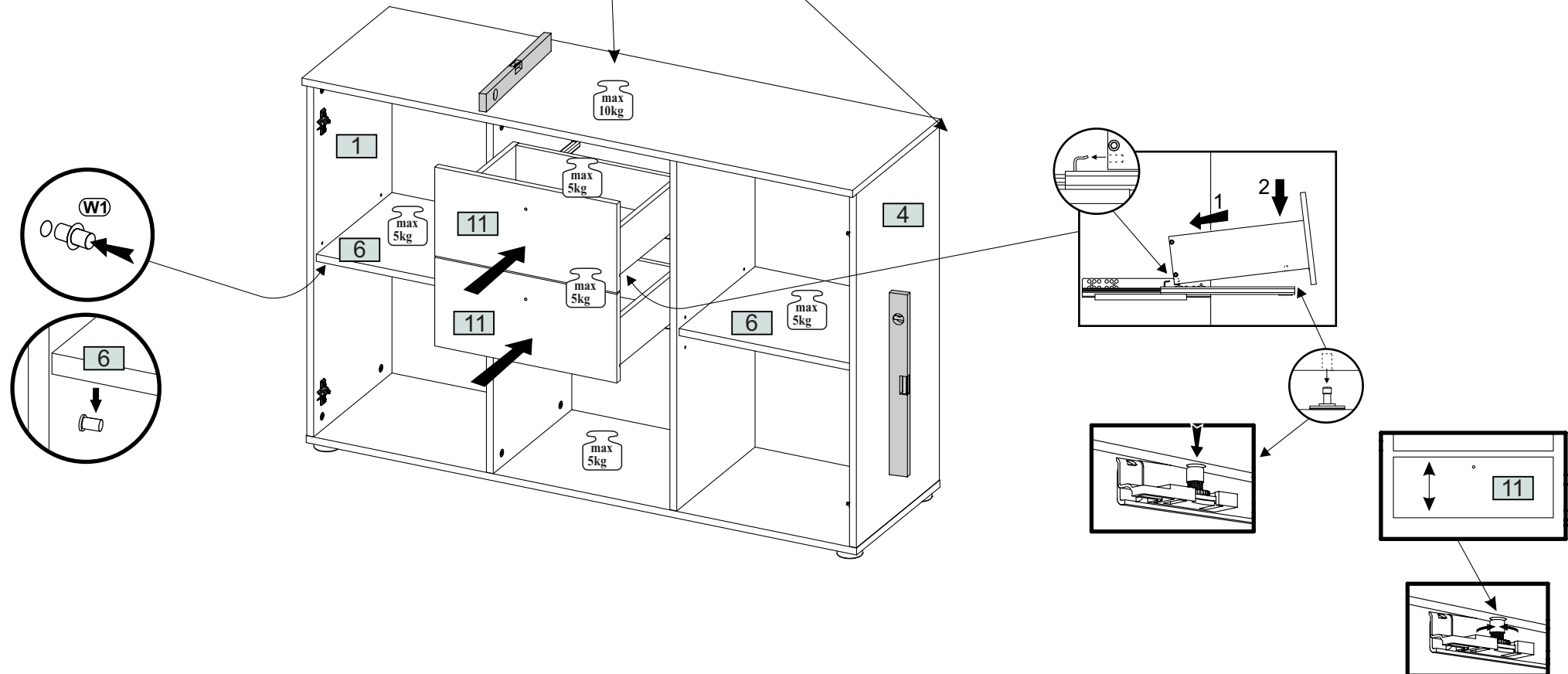
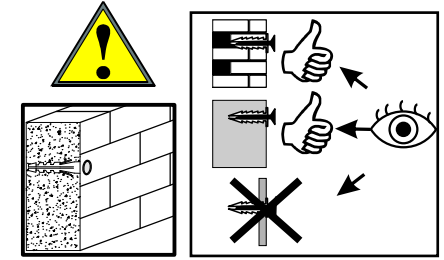
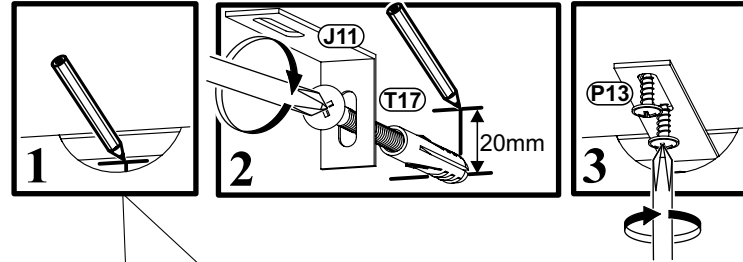
- J11**  x2
- P13**  3,5x13 x4
- T17**   $\varnothing 8 \times 50$  x2
- 5x60**  x2
- W1**  x8





14

<b>F16</b>		x5
<b>A2</b>		M4x25 x5

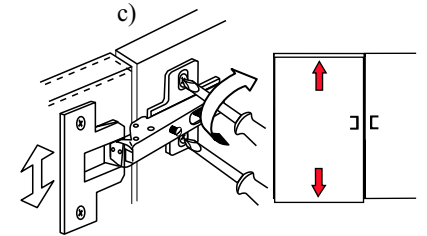
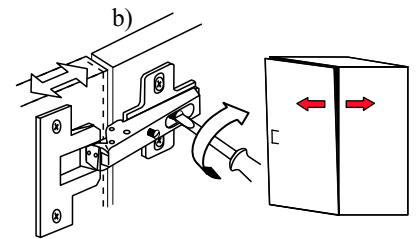
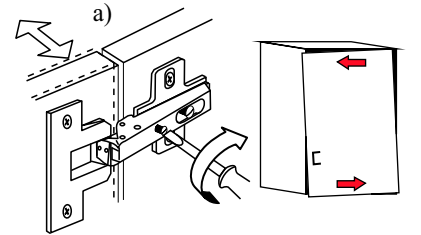
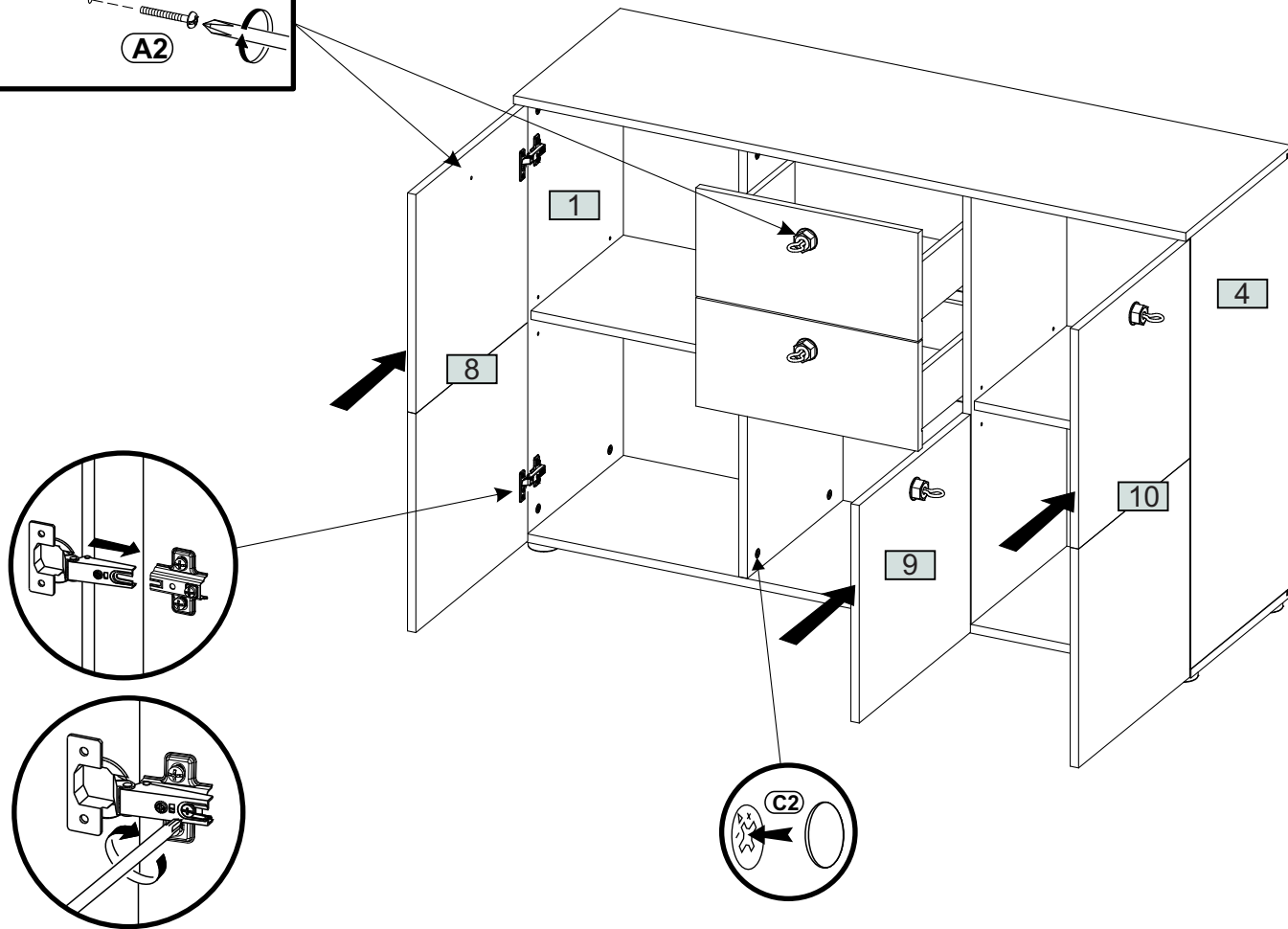
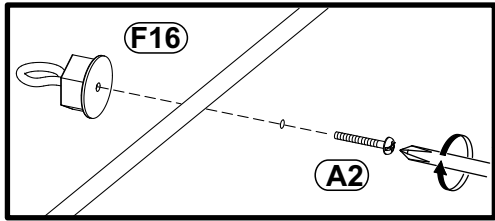
<b>C2</b>		x20
-----------	---	-----



		
---	---	---