

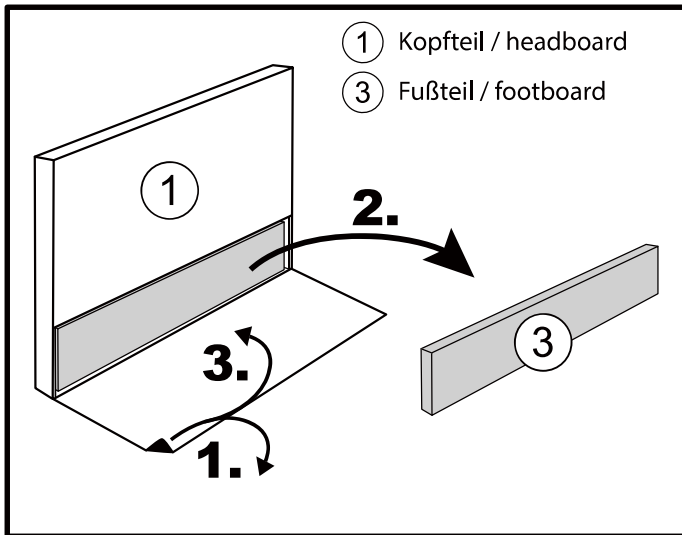

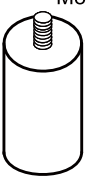

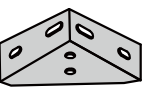



Fußteil im Kopfteil Footboard inside of the headboard

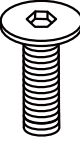
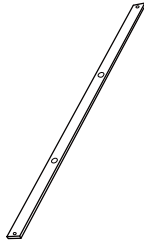

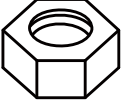
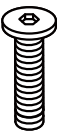
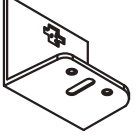
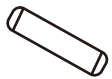
Ascona II by meise (JF8016)

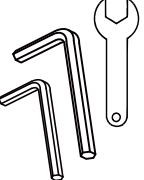
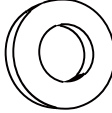
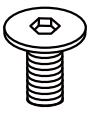
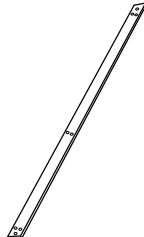
120/140
 160/180
 200cm

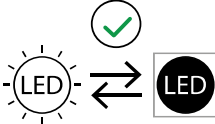
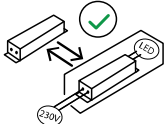
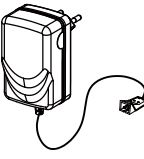
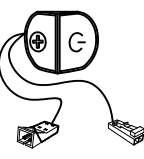
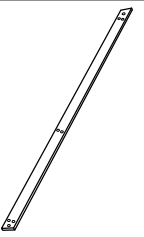
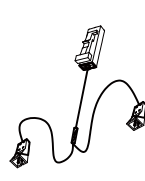
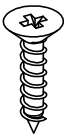
A-108	B-108	C-108	D-108	E-108	F-108	G-108	H-108	I-108
2	4	4	2	16	1	2	2	16
								
H 120	-	-	M6*20	M8*35	1990*70*20	ca 200-320	M8	M6*35
J-108	K-108	L-108	M-108	N-108	O-108	P-108	Q-108	R-108
8	4	1	9	1/1/1	2	36	2	12
								
-	M8*30	For Set 160-200	150*24*2.7mm	4 / 5 / 13	M8	M8*15	2018*100*18	4*20
S-108	T-108	U-108	V-108	W-108	   <p>Dieses Produkt enthält eine Lichtquelle der Energieeffizienzklasse G. / This product contains a light source of energy efficiency class G.</p>			
1	1	1	1	1				
								
24W	-	1250*100*18 1450*100*18 1650*100*18 1850*100*18 2050*100*18	-	-				

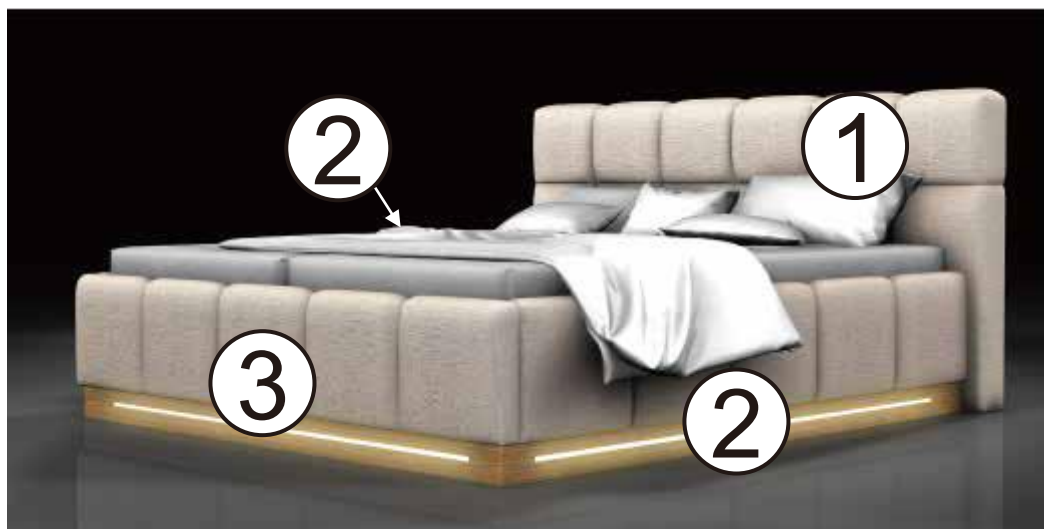

								
---	---	---	---	---	--	--	--	--

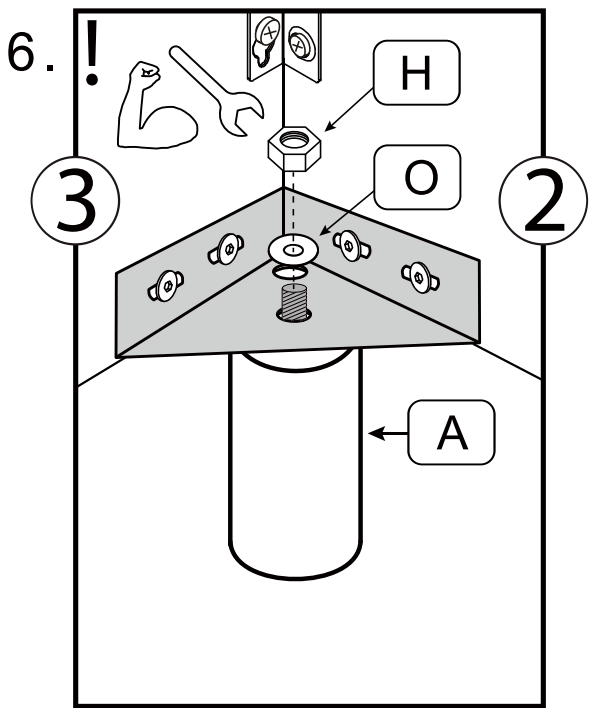
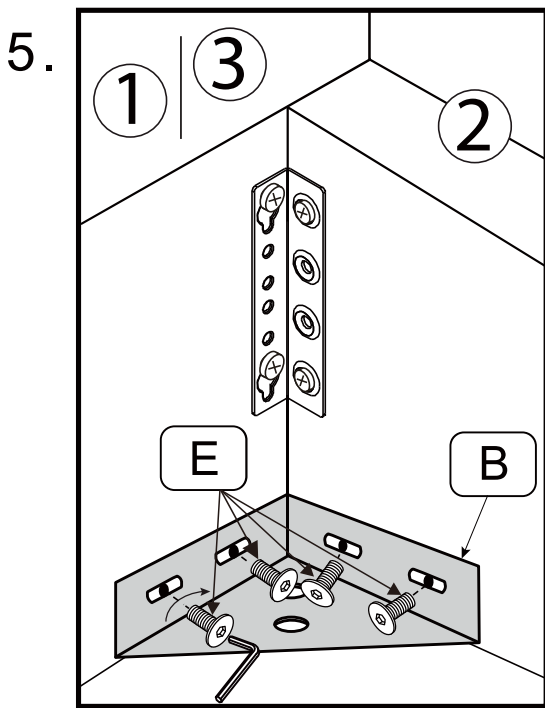
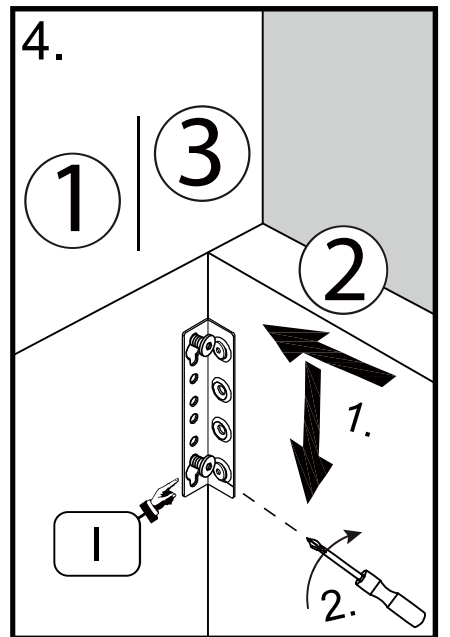
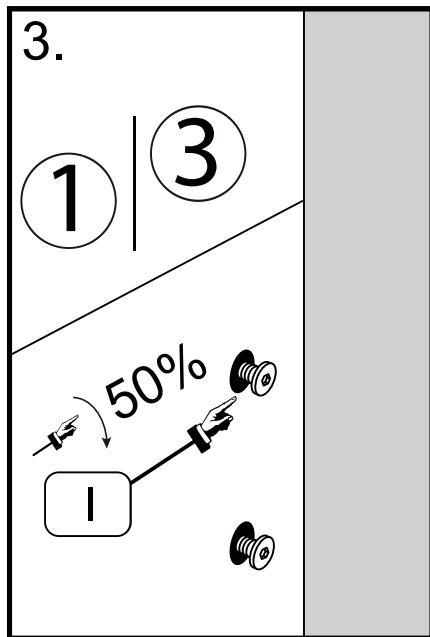
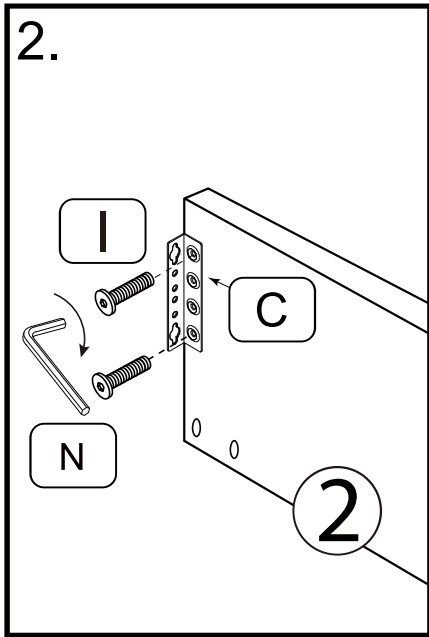
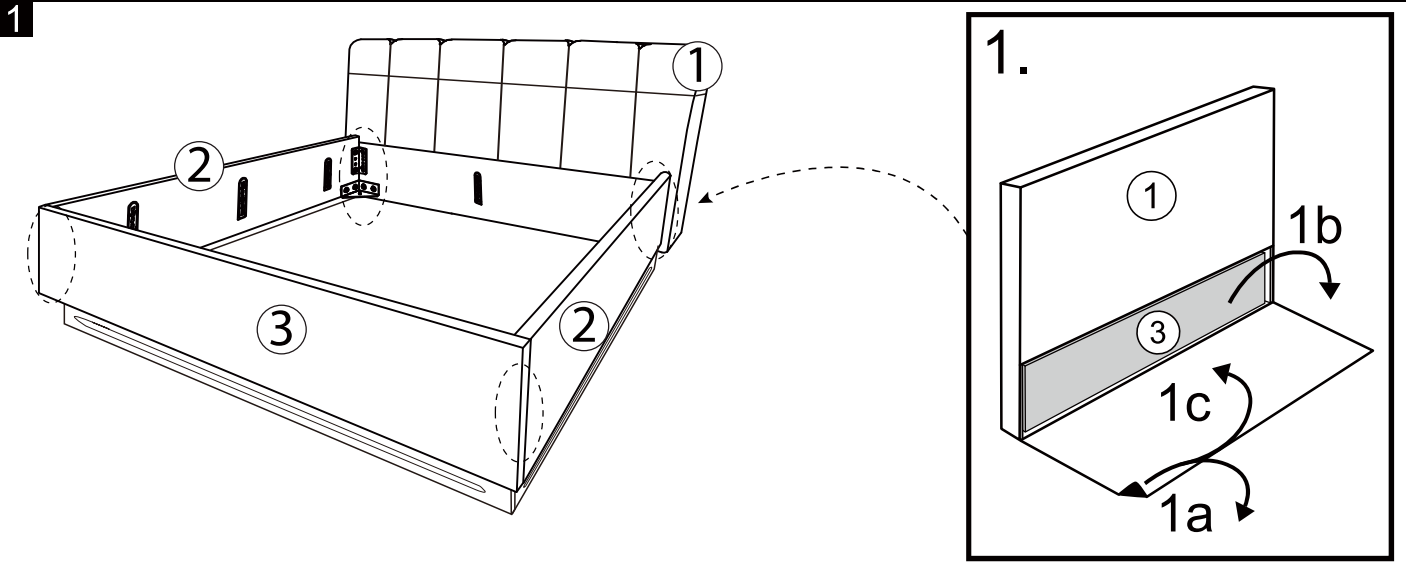

2

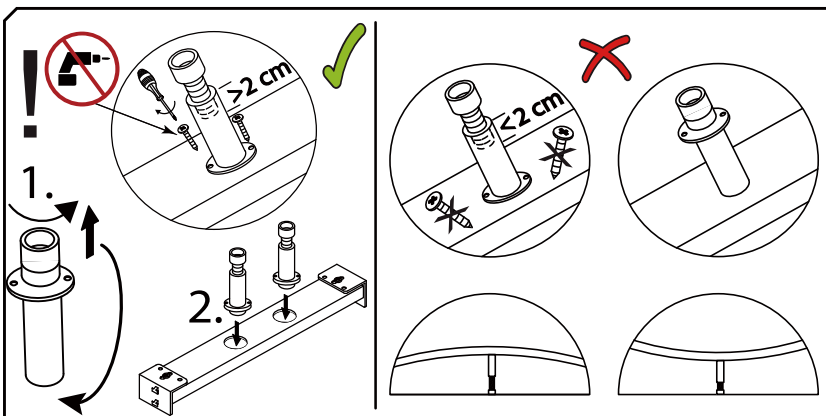
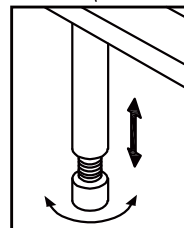
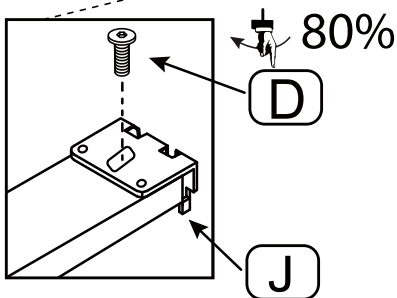
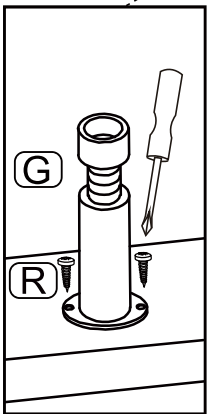
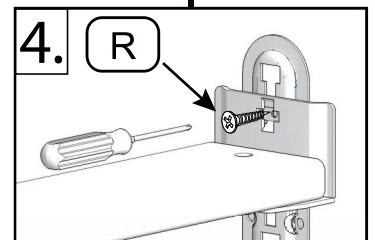
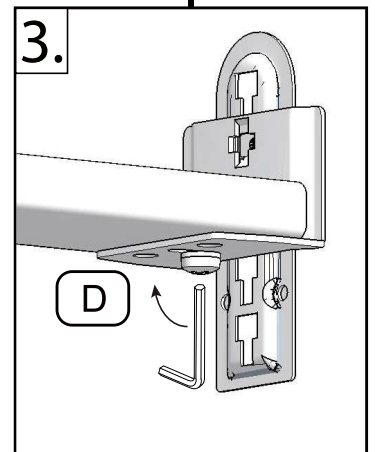
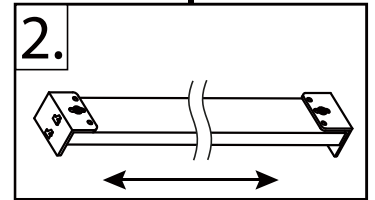
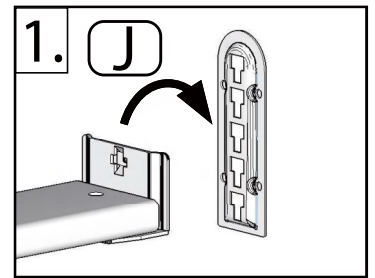
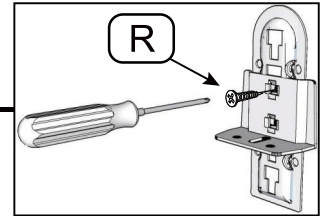
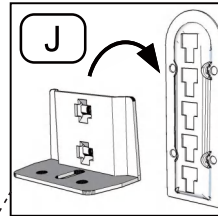
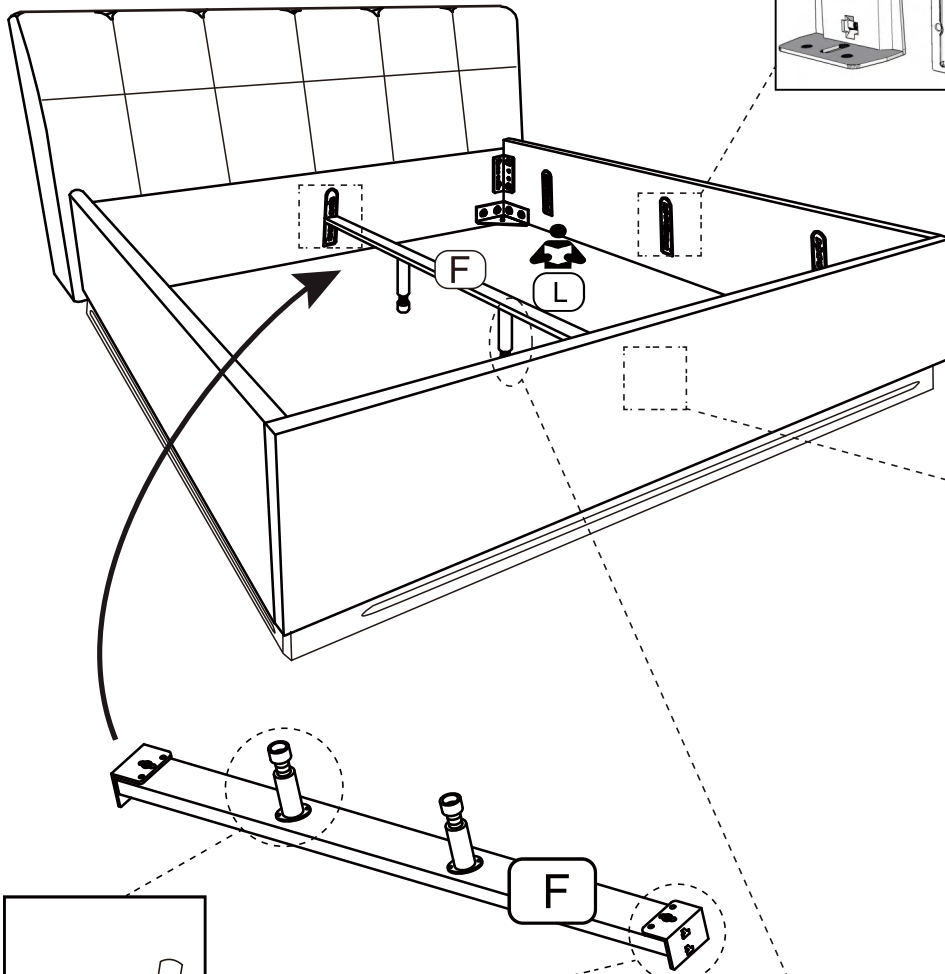

3

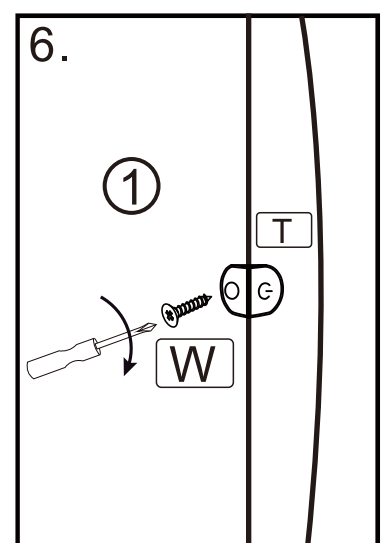
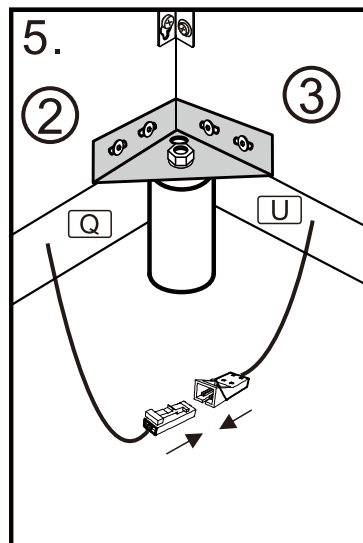
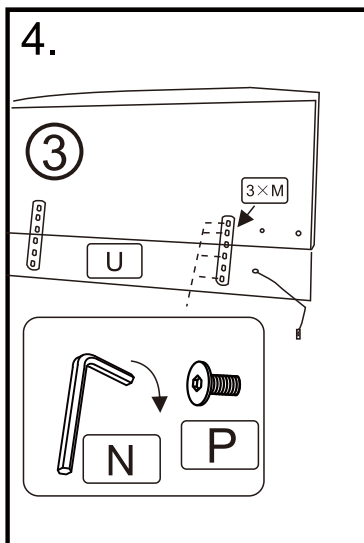
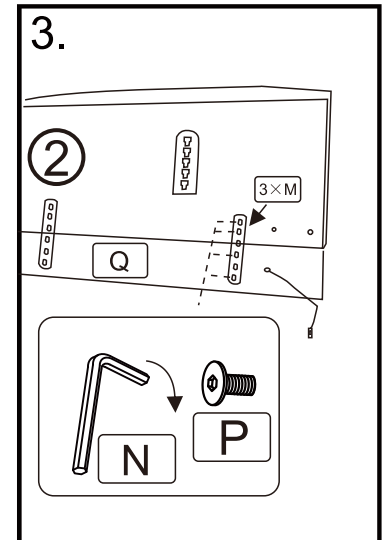
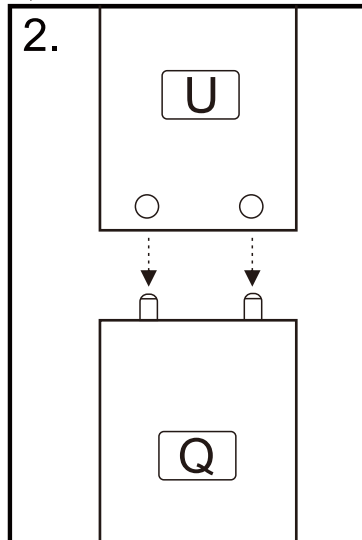
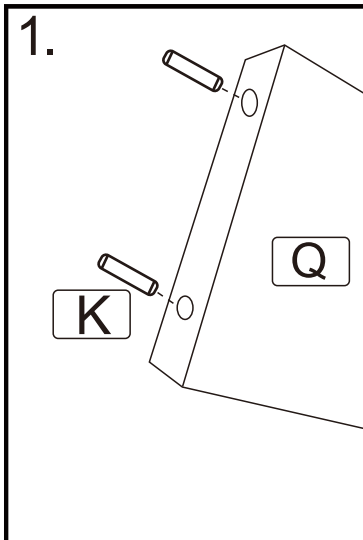
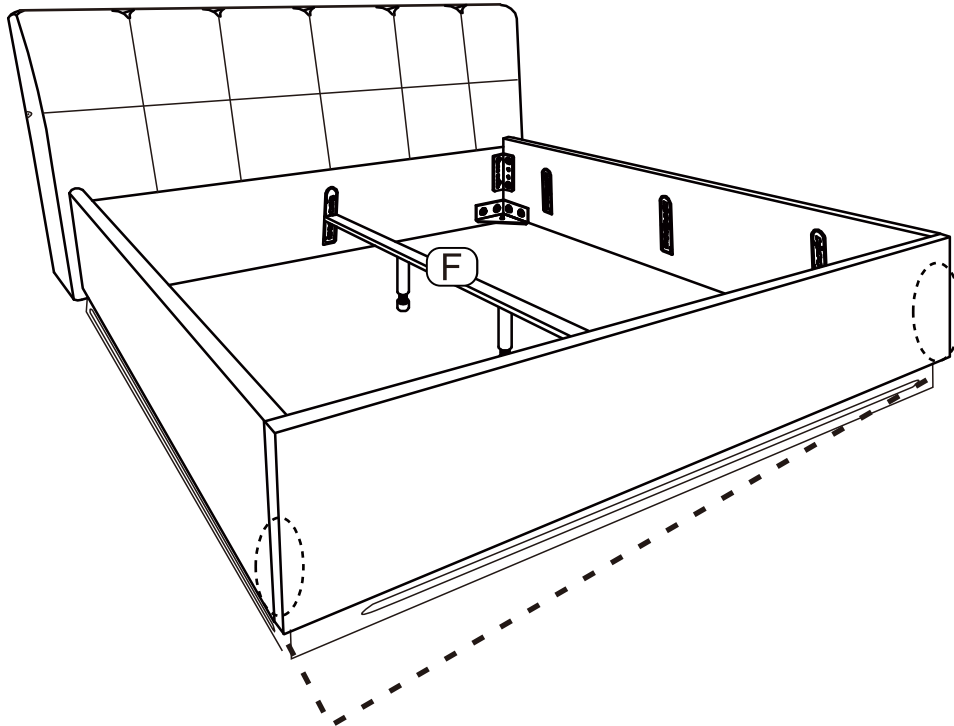

4

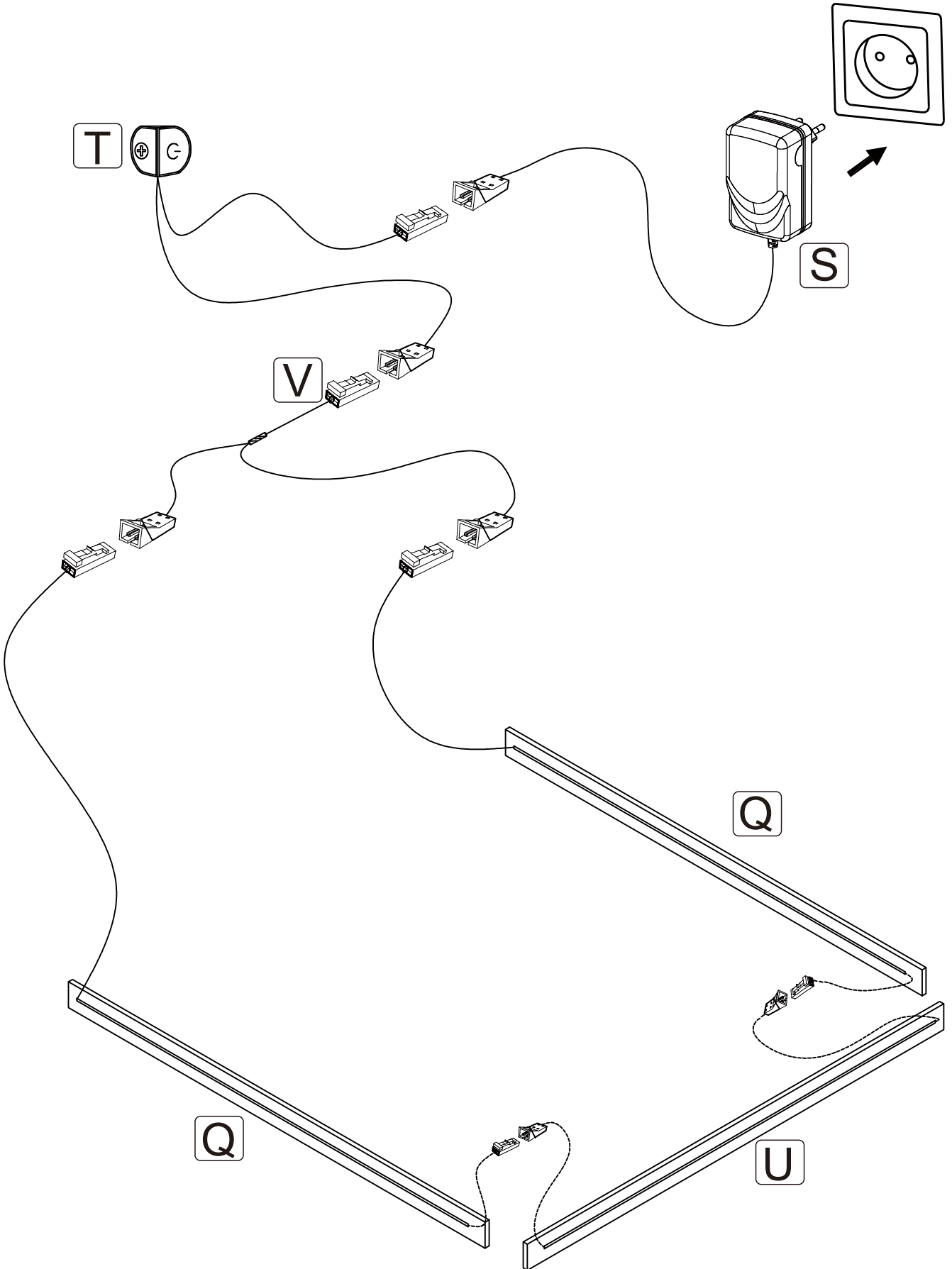

5

Recycling



1.

4 :



3 4 :

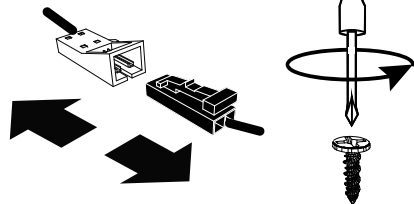

2.

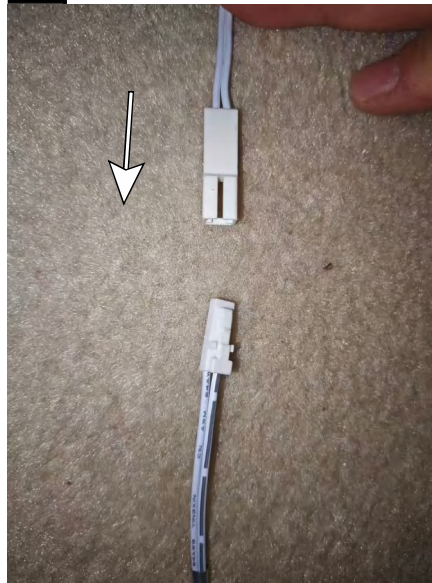

3.



4.

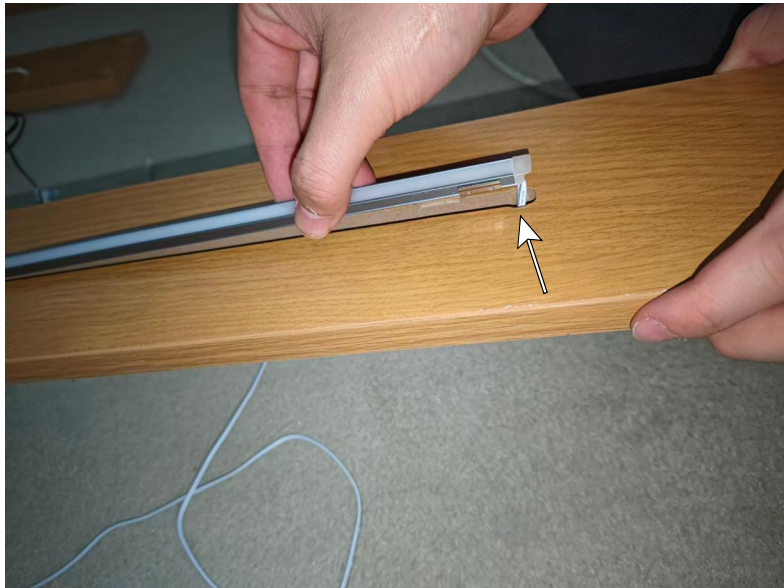

EU - Konformitätserklärung für alle Produkte mit Licht- und / oder Ladeelementen
EU declaration of conformity for all products with light- and / or charging elements.

Meise Möbel GmbH & Co. KG

erklärt für Produkte mit LED und / oder USB-Ladeelementen die Einhaltung und

Entsprechung der EG-Richtlinien:

Meise Möbel GmbH & Co. KG

declares for products with LED and / or USB charging elements, compliance and conformity with EC directives:

LVD 2014/35/EU

EMV 2014/30/EU

RoHS 2011/65/EU & 2015/863/EU

ERP 2009/125/EG

und der Anwendung harmonisierter Normen / and of standards:

PN-EN IEC 60598-1:2021-07+A11:2022-11

PN-EN 60598-2-2:2012

EN 61347-1:2015

EN 61347-2-13: 2014 + A1:2017

EN 55015:2019+A11:2020

EN 61547:2009

EN IEC 61000-3-2:2019+A1:2021

EN 61000-3-3:2013+A1:2019

EN 62471:2008

EN 62479:2010

PN-EN IEC 63000:2019-01

(UE) 2019/2020 & (UE) 2021/341

Dokumentationsbevollmächtigte / Authorised representative for documentation:

Meise Möbel GmbH & Co. KG

Klosterbauerschafter Straße 27

32278 Kirchlengern

Deutschland

info@meisemoebel.de

Hiermit wird bestätigt, dass das oben genannte Produkt den genannten

EG-Richtlinien entspricht.

This is to certify that the above product complies with the above

EC directives.

Kirchlengern, 27.11.2024

Meise Möbel GmbH & Co. KG

Klosterbauerschafter Str. 27

32278 Kirchlengern

Tel. 05223 / 18 09 8-0

Fax 05223 / 18 09 8-29



Sven Knabe







Geschäftsführer

Die alleinige Verantwortung für die Ausstellung dieser Konformitätserklärung trägt der Hersteller.

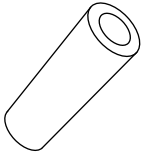
The manufacturer bears sole responsibility for issuing this declaration of conformity.

SPACER

160 cm
 180 cm
 200 cm
 240 cm

-	A-86	B-86					
1 Set ->	4	4			10 min		
							
1-Set	10*35	4*50					

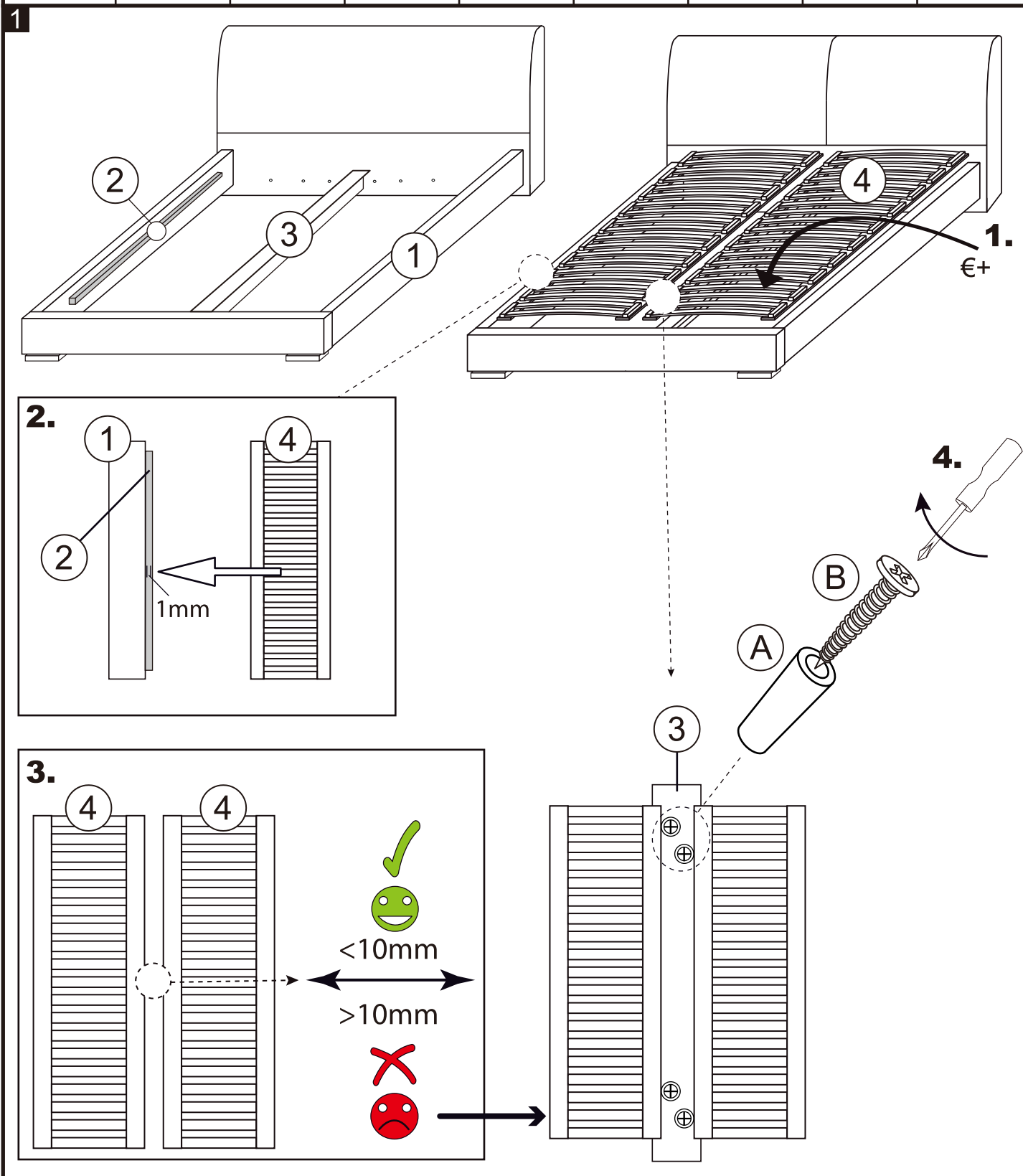



„Wichtig: Gebrauchs- und Montageanleitung für spätere Bezugnahme aufbewahren, sorgfältig lesen“

"Important: for future reference please keep the assembly instruction, read it carefully"

„Important : Notice d'utilisation et de montage pour toute référence ultérieure, à conserver et à lire attentivement.“

Modelle mit Lichtquellen: Die Lichtquellen und die separaten Steuerungselemente können zur Überprüfung durch die Marktüberwachungsbehörde / als Austauschteil aus dem umgebenden Produkt entnommen werden, ohne sie dauerhaft zu zerstören.

Anweisungen dazu finden Sie in der technischen Dokumentation des Produktes.

Models incl. LED Light: The light sources and the separate control elements can be removed from the surrounded product for inspection by the market surveillance authority / as replacement part without permanently destroying them. Instructions for this can be found in the technical documentation of the product.

Modèles avec sources lumineuses : Les sources lumineuses et les éléments de commande séparés peuvent être retirés du produit environnant pour être contrôlés par l'autorité de surveillance du marché / en tant que pièce de rechange sans être détruits de manière permanente. Vous trouverez des instructions à ce sujet dans la documentation technique du produit.

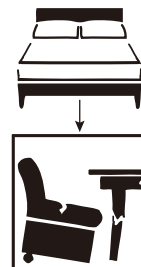
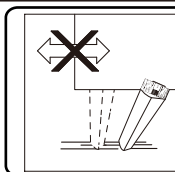
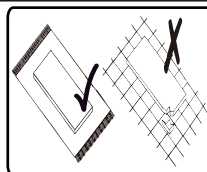
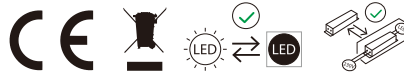

Sperrmüll / bulky waste / Déchets encombrants

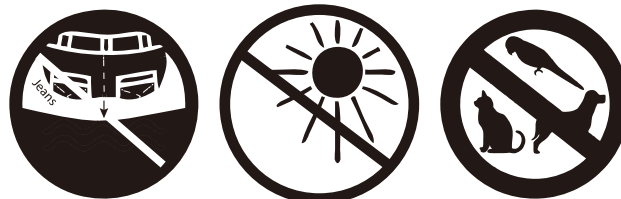
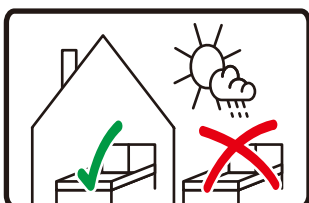
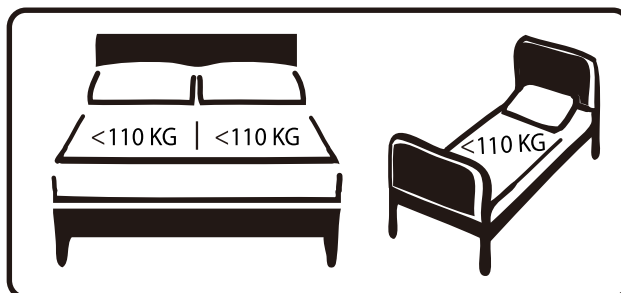
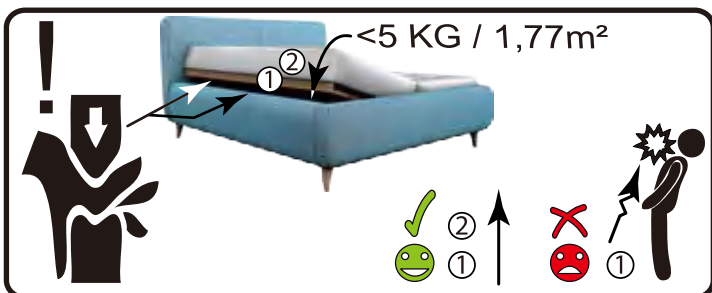

Ä ä à é Ä Å w ä w / návod k montáži / monteringsv
ning / instrucciones de montaje / monteerimisjuhendid /
instructions de montage / asennusohjeet / M
N : N / szerelési útmutató / upute za montažu /
istruzioni di montaggio / montužas instrukcijas / surinkimo
instrukcijos / montage-instructies / instruções de montagem /
instrukcja montaGu / instruc 'iunile de asamblare / Ä ä à é Ä Å
à à / monteringsanvisningar / návod na montáž /
navodila za montažo / montaj talimatları