

INSTRUCTION SHEET

22240015-01

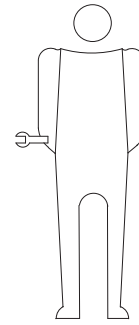

x1

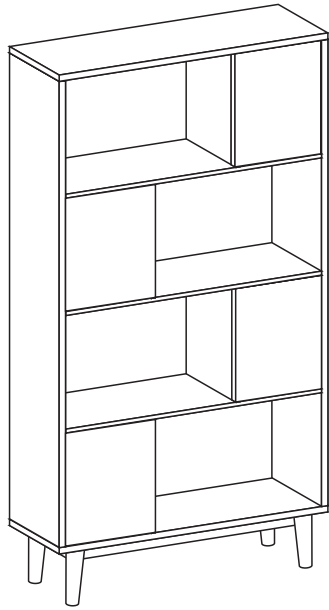

Ax1

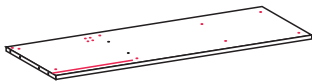

Bx2



Cx1

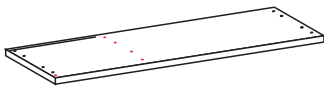

Ex1



Fx1

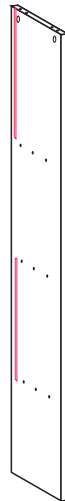

Gx1



Hx2



Ix2

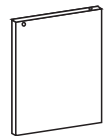

Kx4

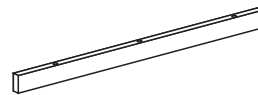

Lx2



Nx4









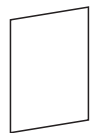













Ox2



Mx4



Px4

 Ø4×35mm ax14	 bx24	 cx36	 dx24	 Ø5×50mm ex10	 Ø4×14mm fx2	 gx2	 hx2
 ix8	 jx8	 Ø3×16mm kx32	 lx4	 mx4	 Ø4×25mm nx16	 ox4	 Ø3×10mm px4
 qx16	 rx12	 sx4	 tx1				

Step 1

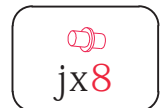
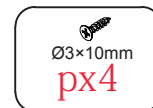
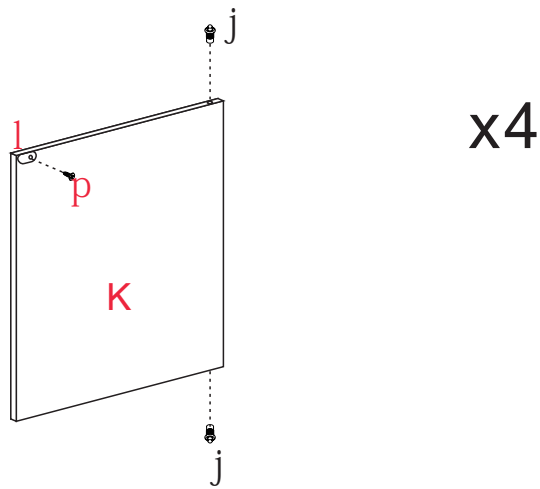

Step 2

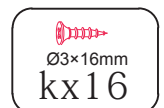
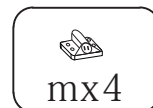
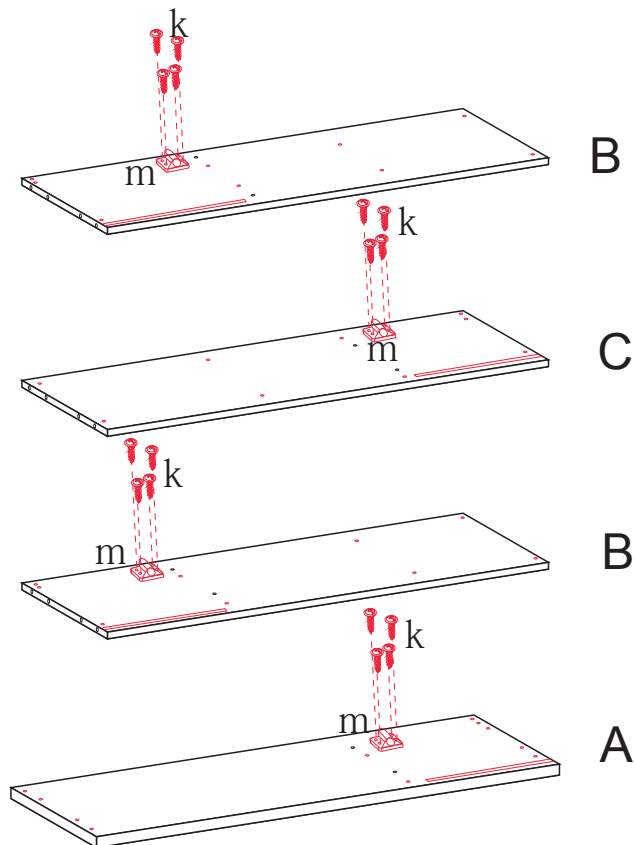

Step 3

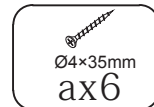
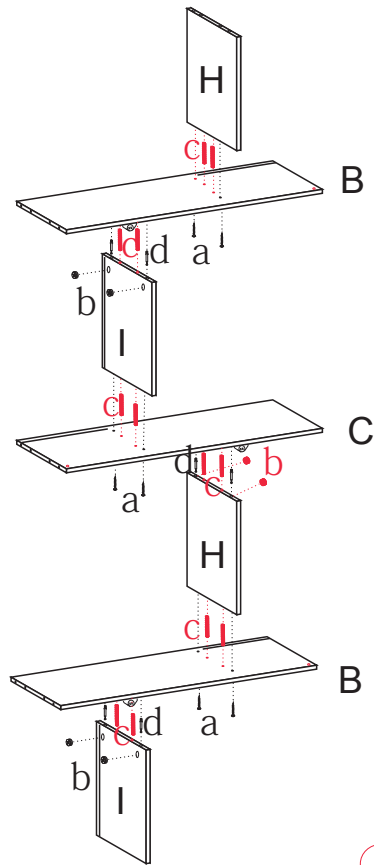

Step 4

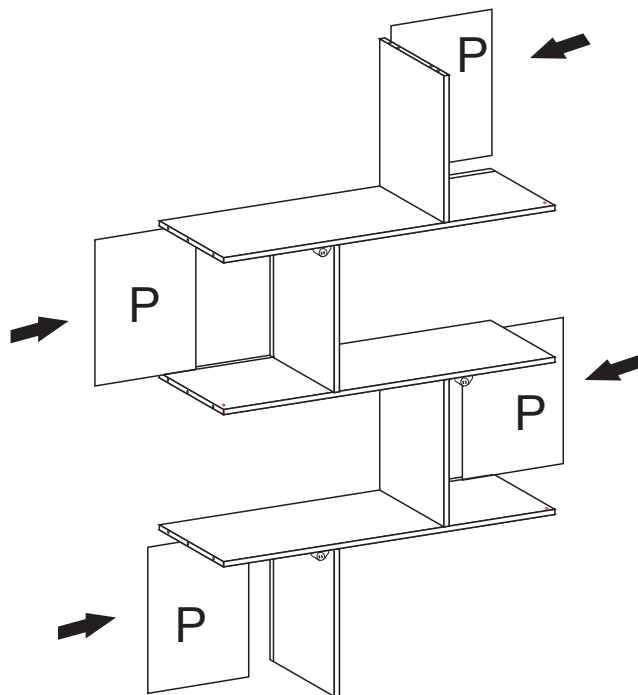

Step 5

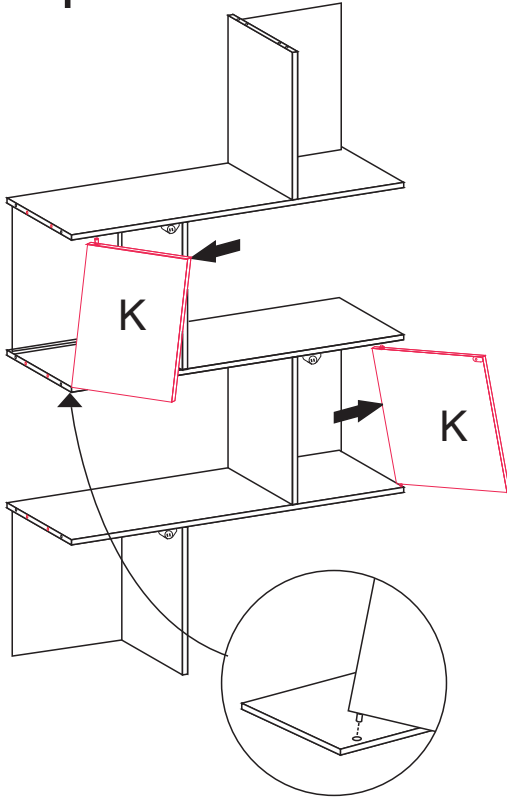

Step 6

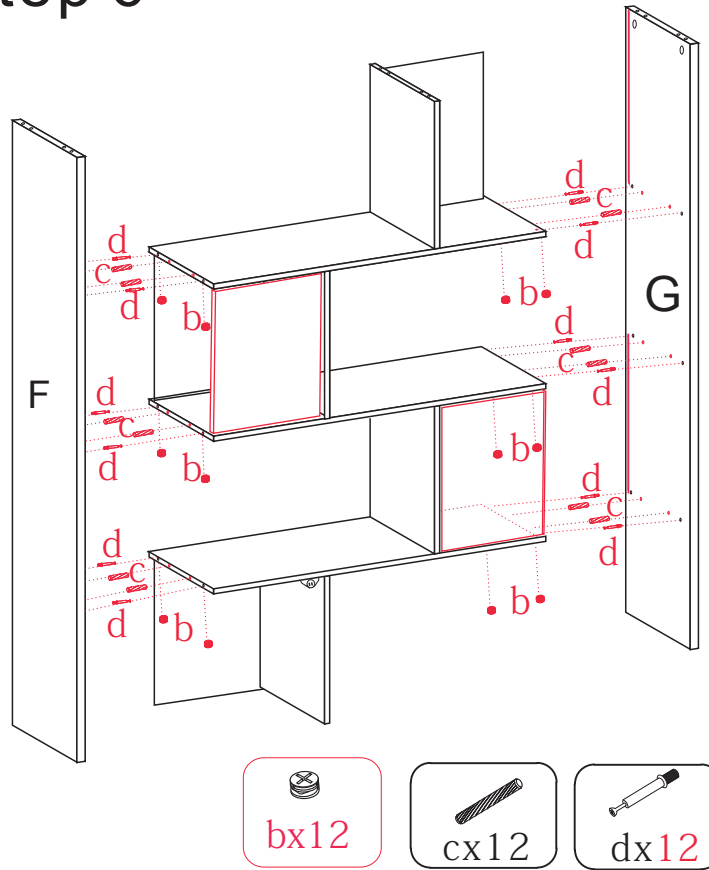

Step 7

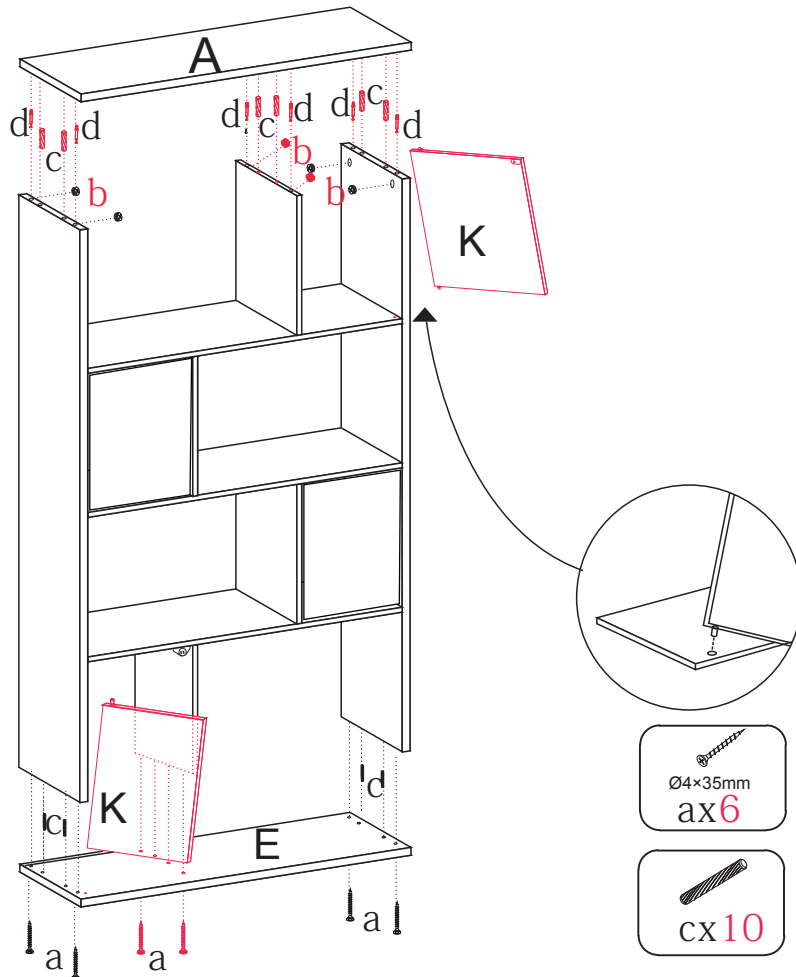

Step 8

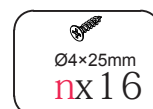
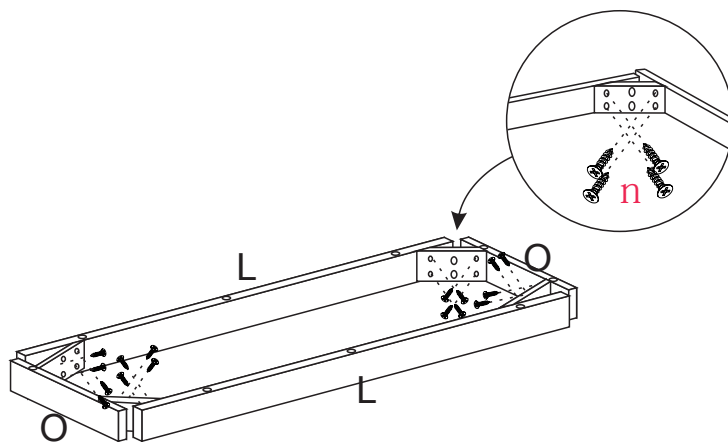

Step 9

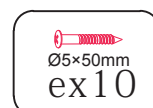
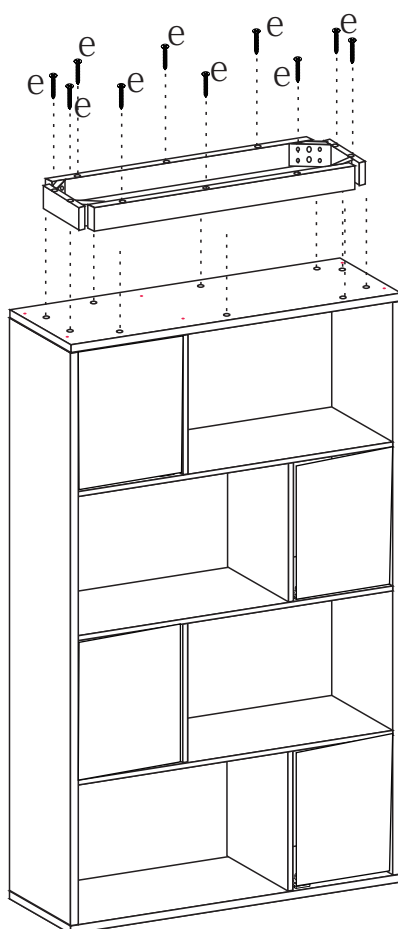

Step 10

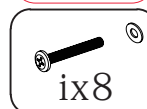
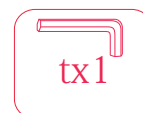
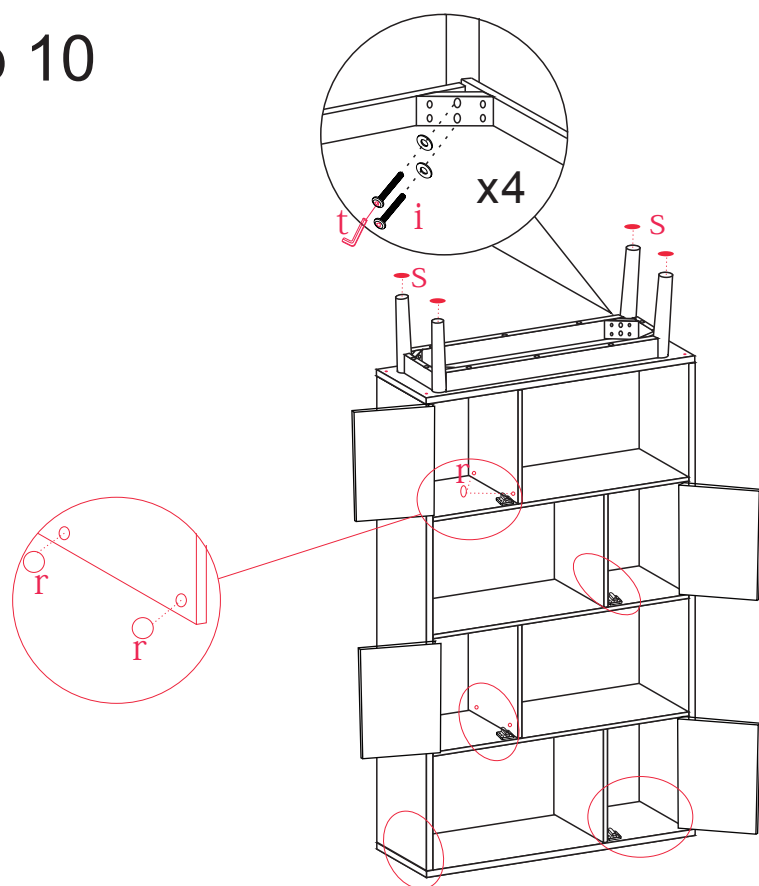

Step 11

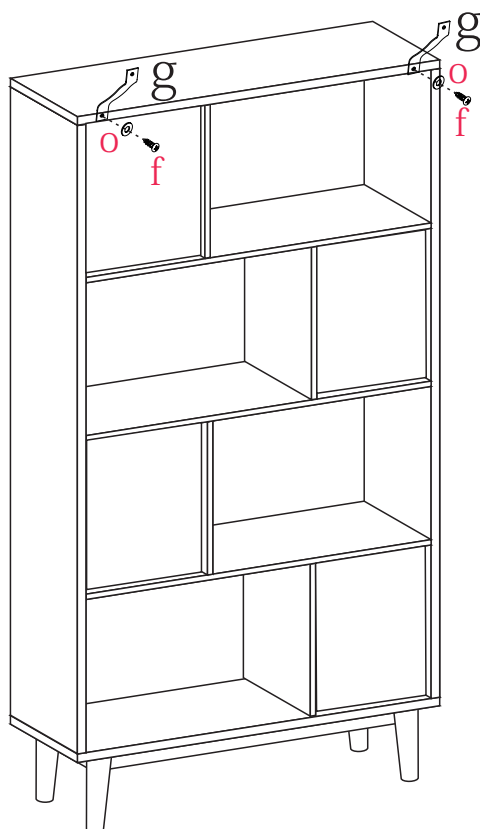

Step 12

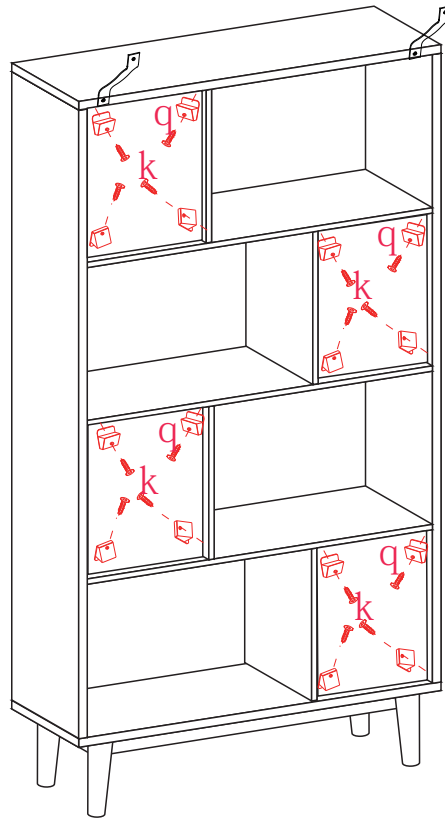

Step 13

