

<http://www.bega-gruppe.de>

874/2012

- | | |
|----|----------------|
| BG | Bulgarisch |
| CS | Tschechisch |
| DA | Dänisch |
| DE | Deutsch |
| ET | Eströisch |
| EL | Griechisch |
| EN | Englisch |
| ES | Spanisch |
| FR | Französisch |
| FI | Finnisch |
| HR | Kroatisch |
| HU | Ungarisch |
| IT | Italienisch |
| LV | Lettisch |
| LT | Litauisch |
| NL | Niederländisch |
| PL | Polnisch |
| PT | Portugiesisch |
| RO | Rumänisch |
| SK | Slowakisch |
| SL | Slowenisch |
| SV | Schwedisch |

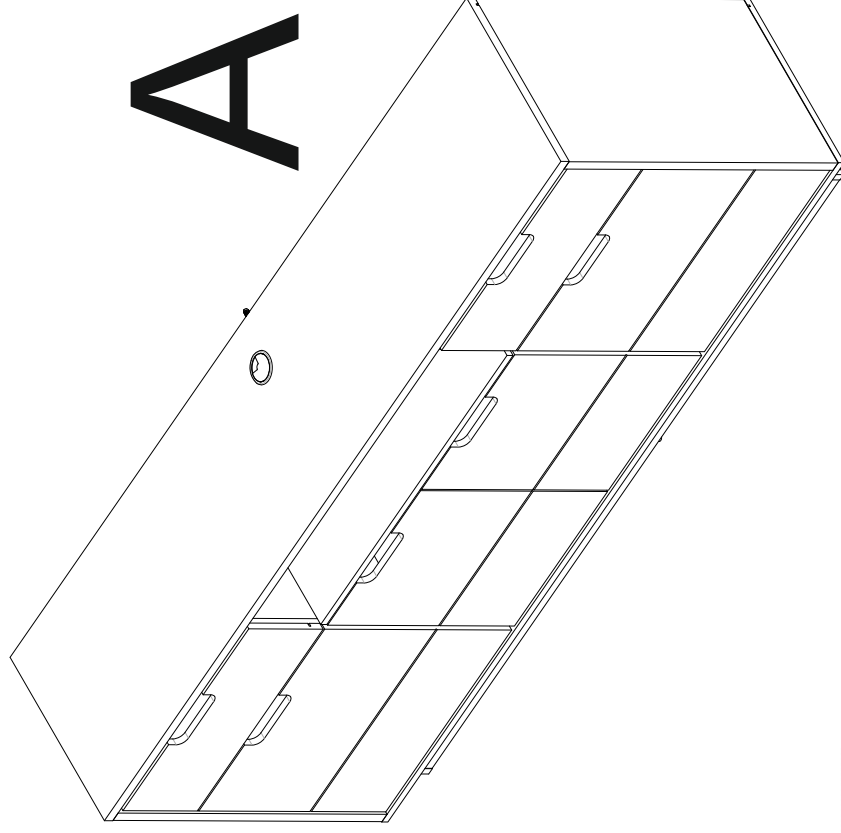

A

120 min



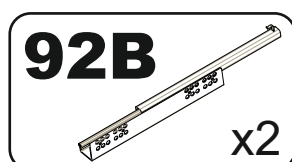
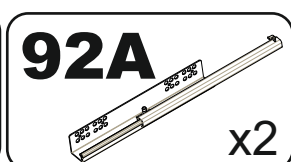
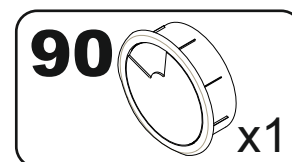
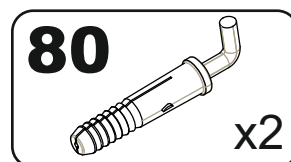
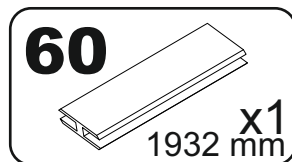
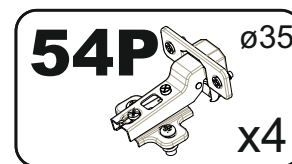
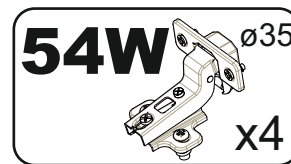
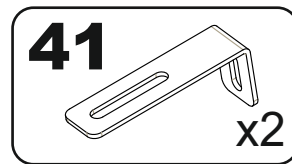
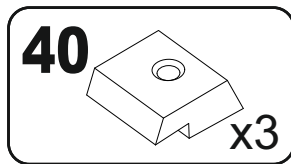
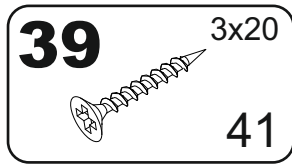
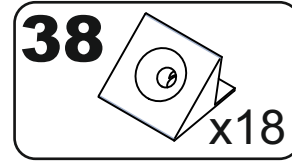
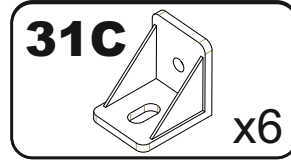
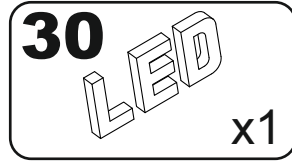
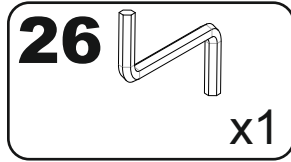
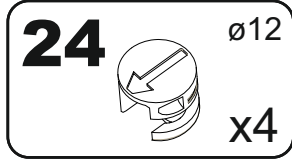
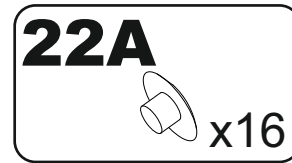
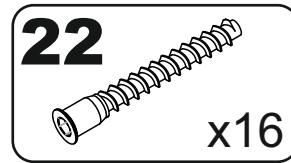
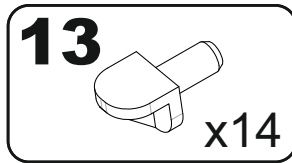
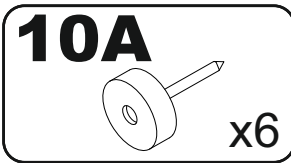
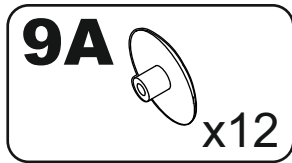
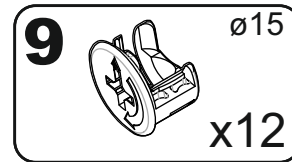
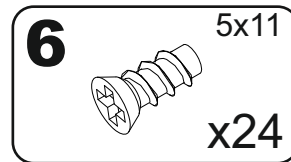
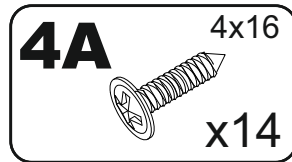
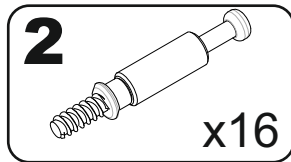
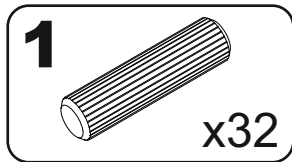
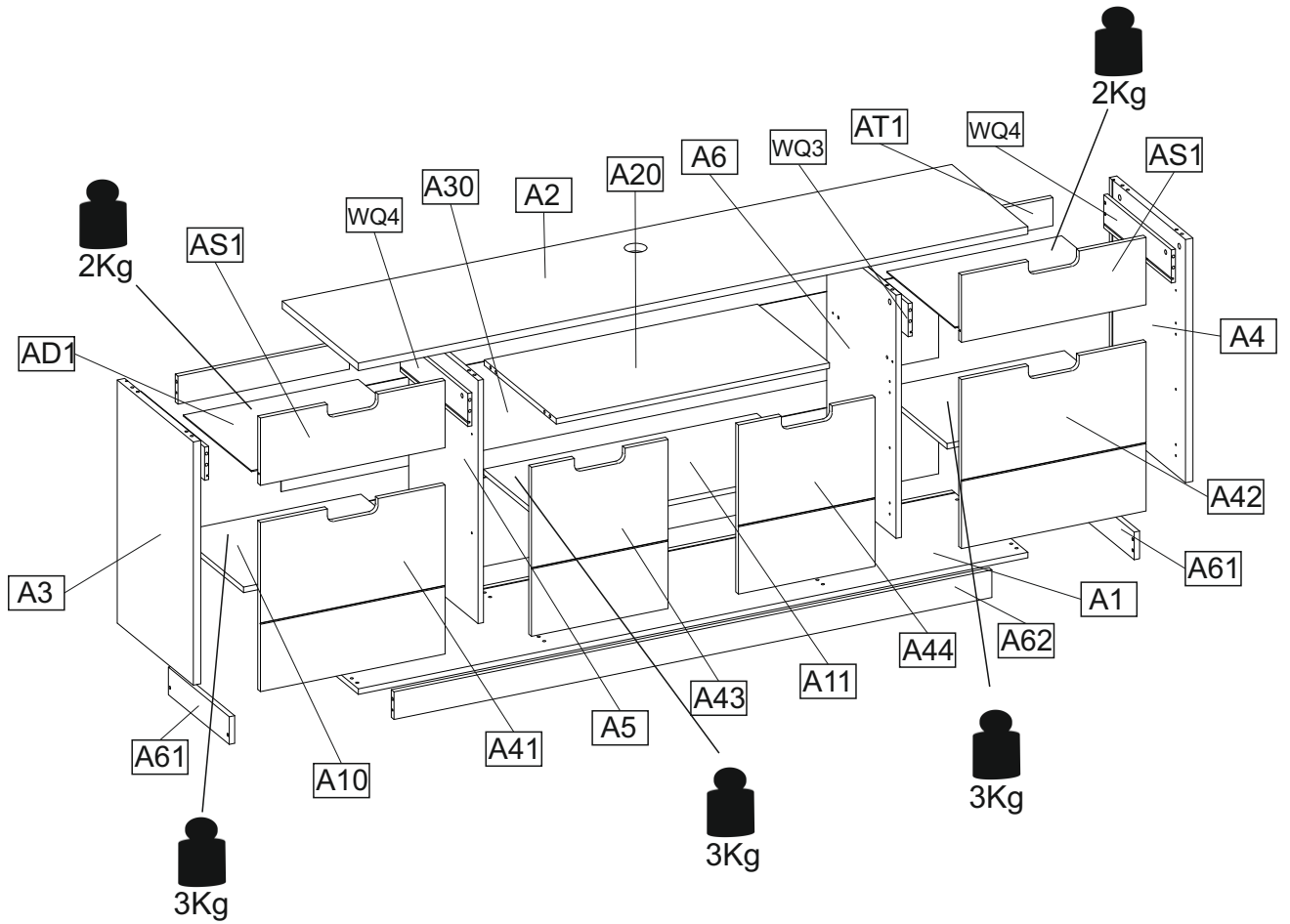
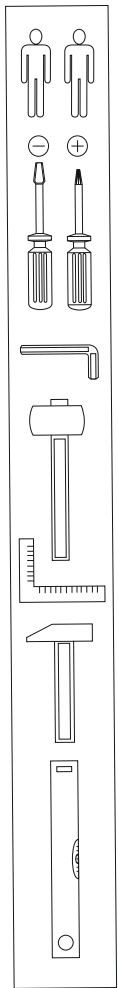

1

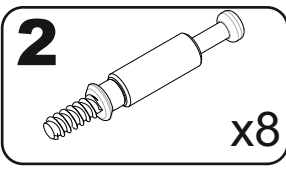

A2 1980x450

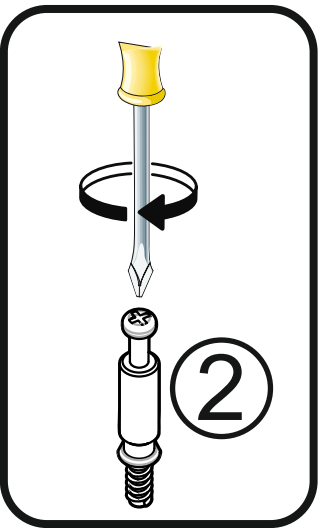
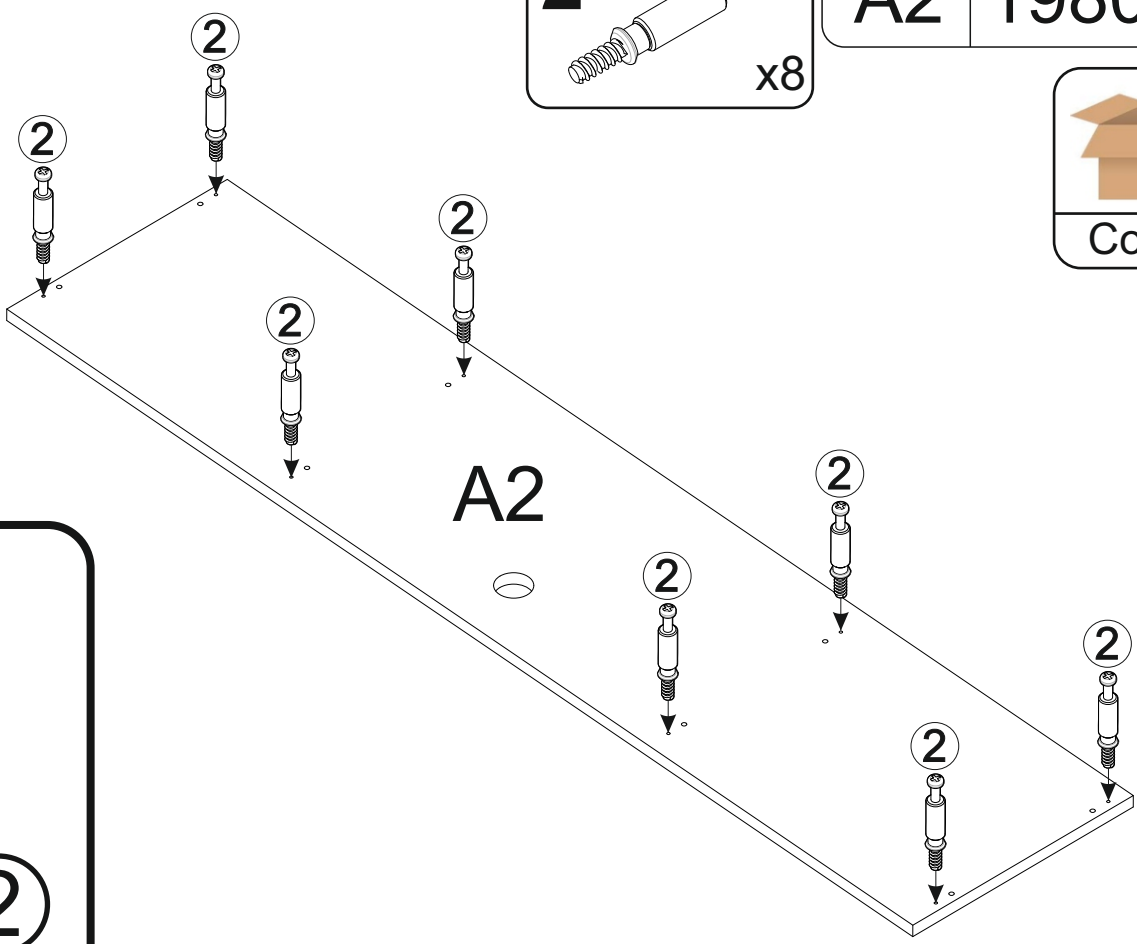
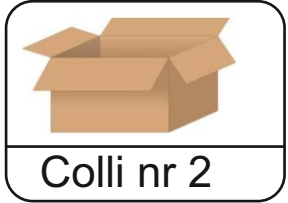

2

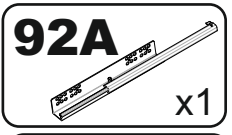
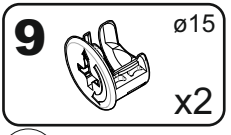
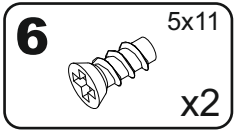
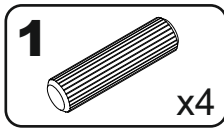

A3 705x450

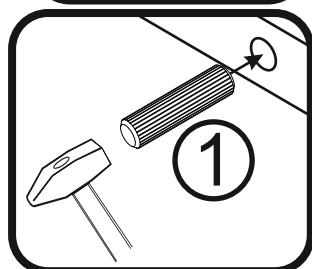
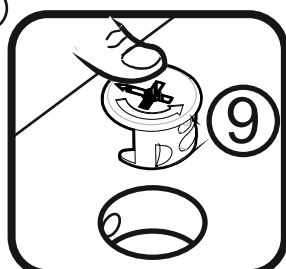
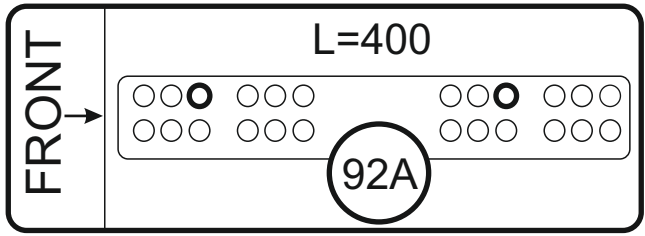
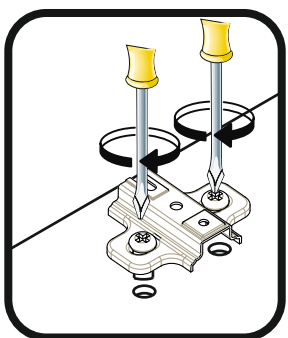
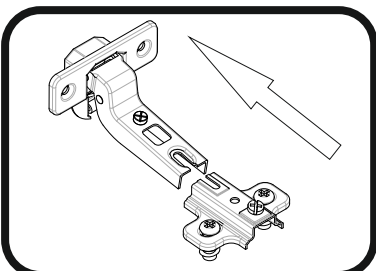
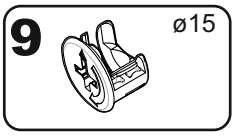
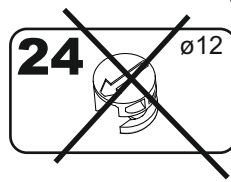
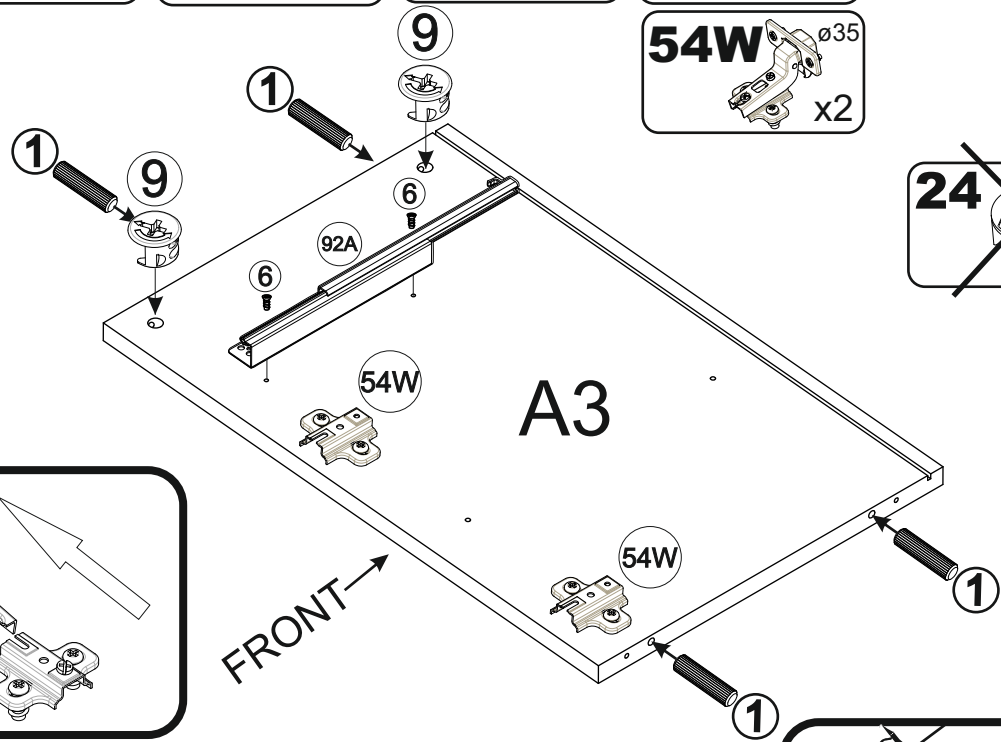
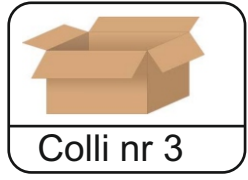

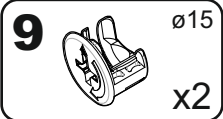
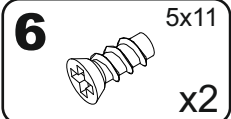
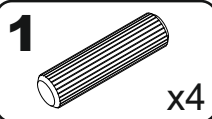
3

A4 705x450

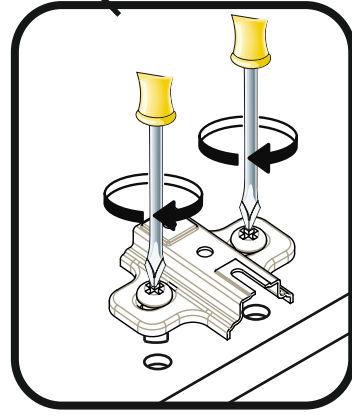
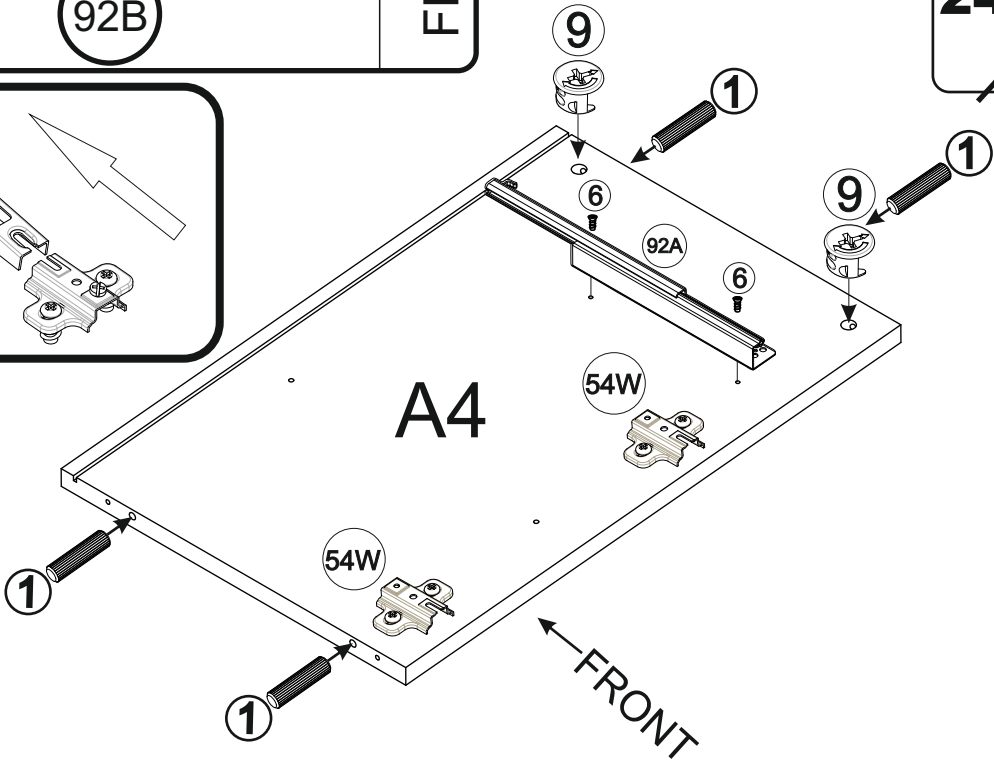
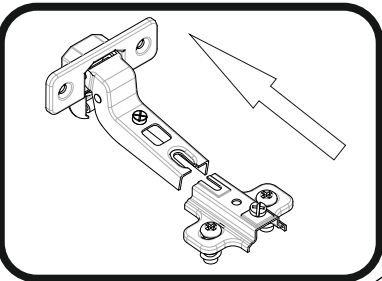
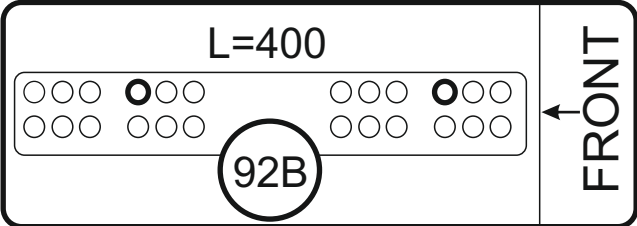
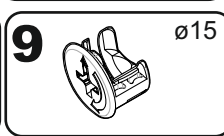
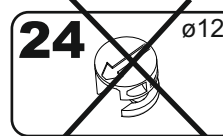
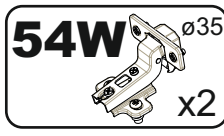
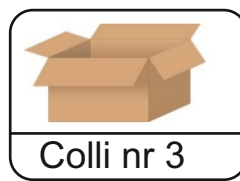
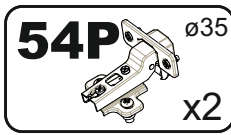
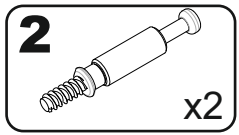
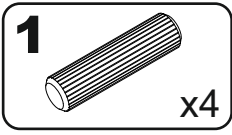
**4**

A5 705x400

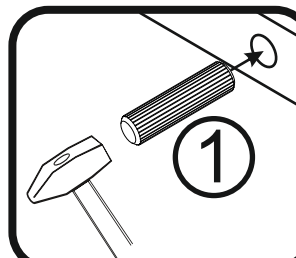
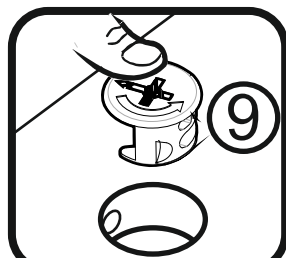
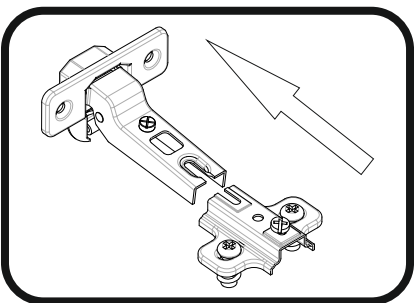
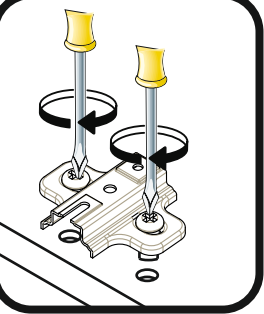
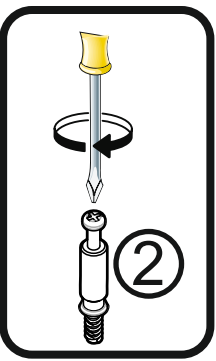
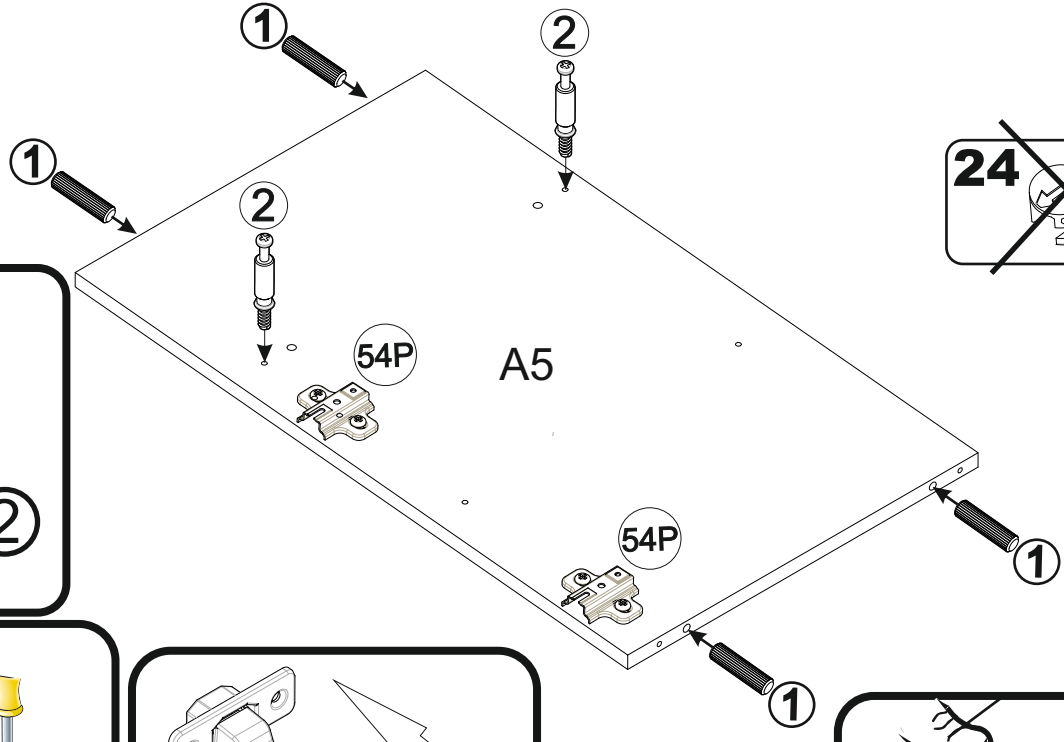
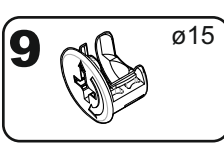
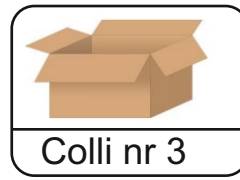

5

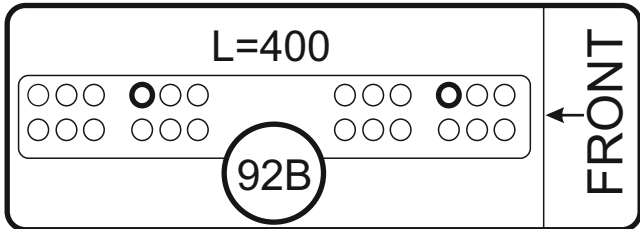
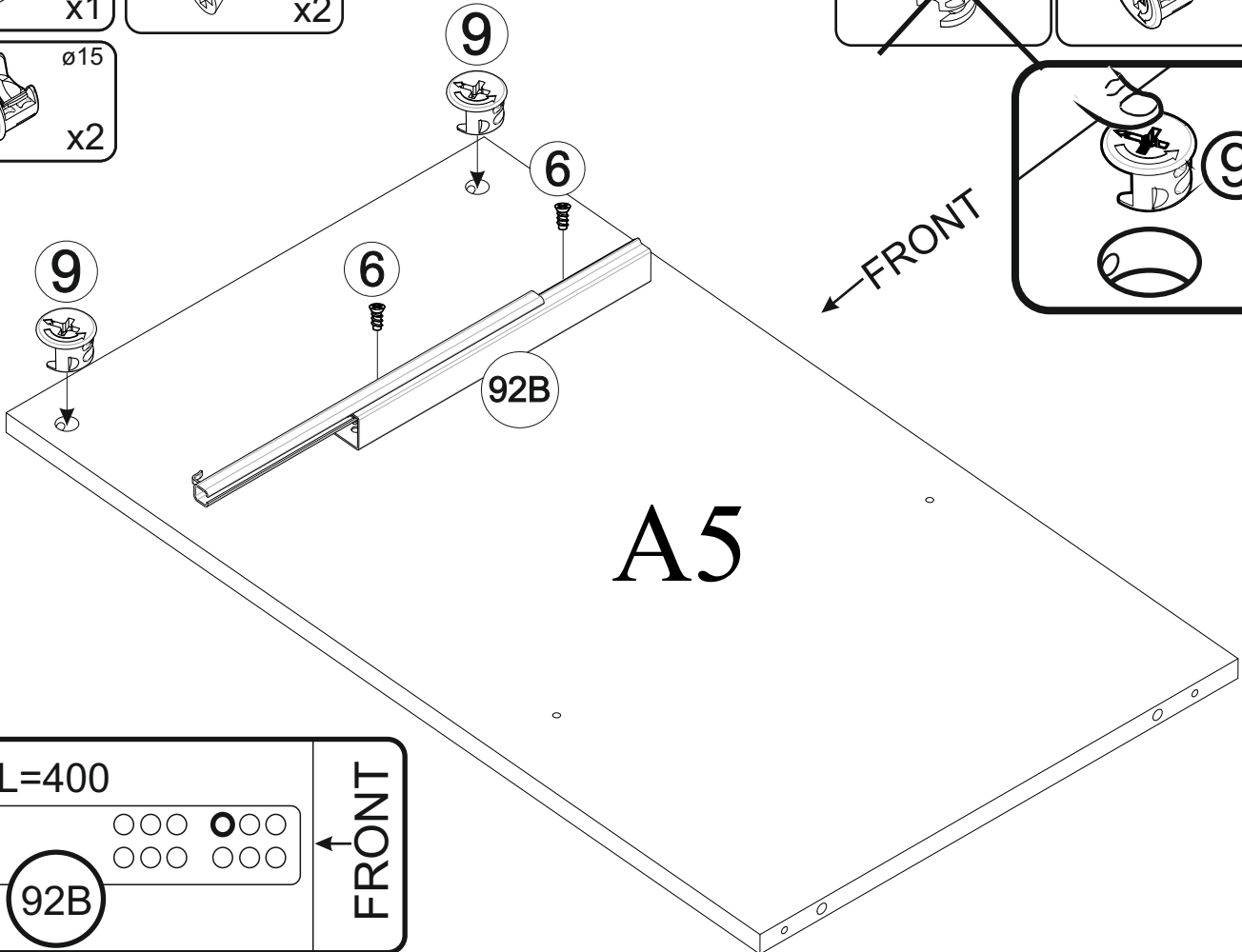
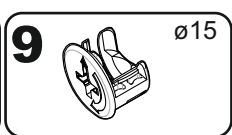
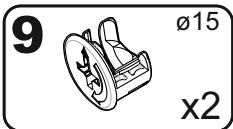
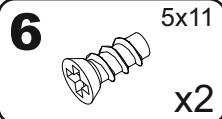
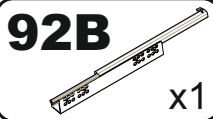

6

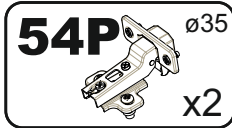
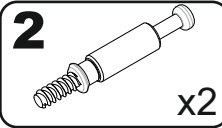
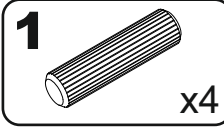

A5 705x400

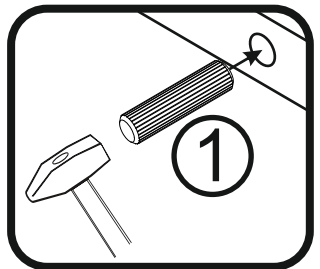
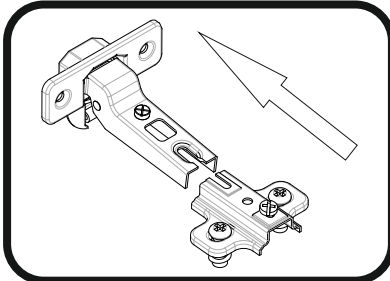
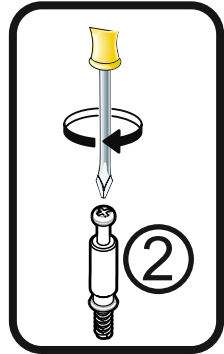
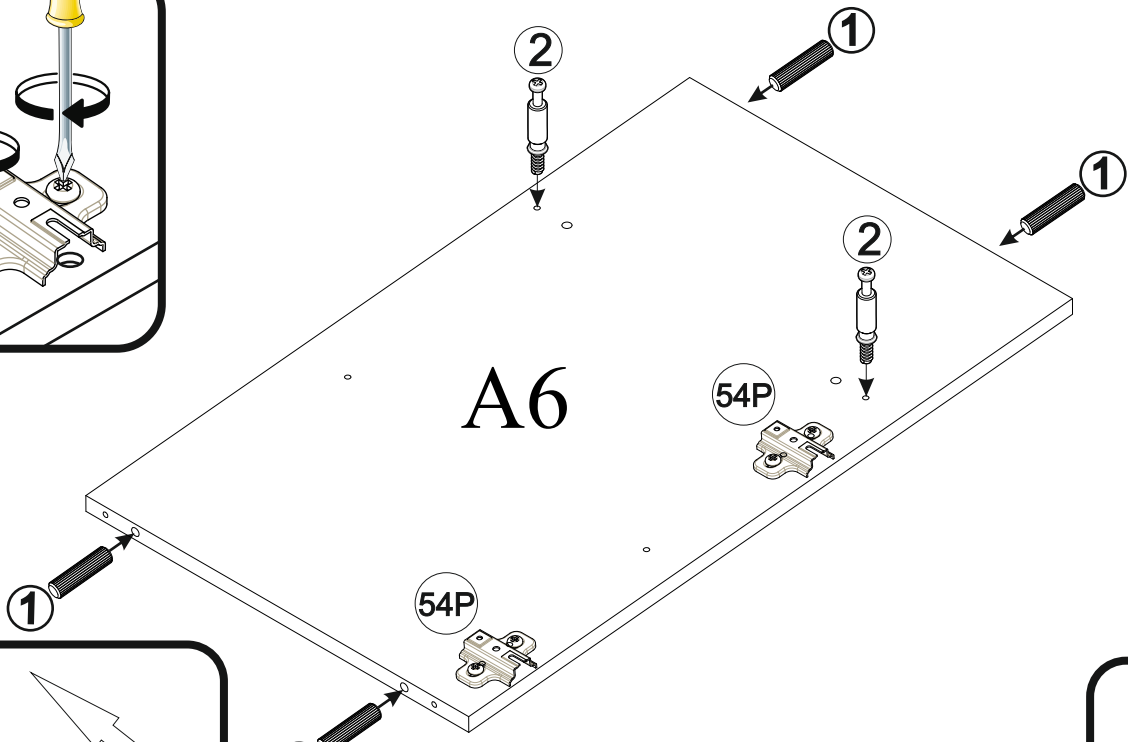
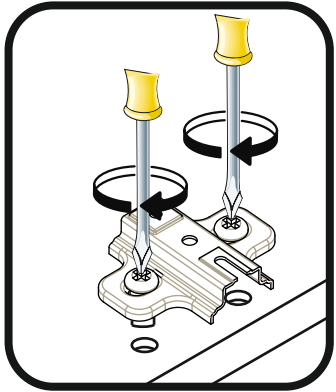
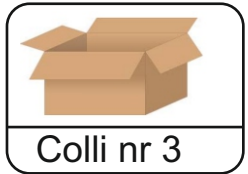

7

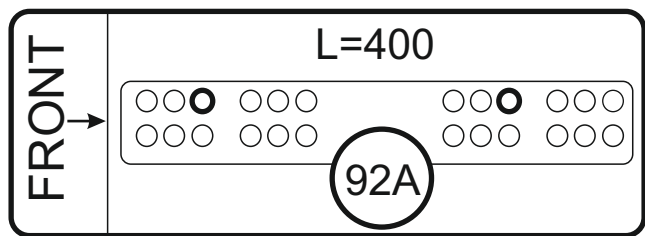
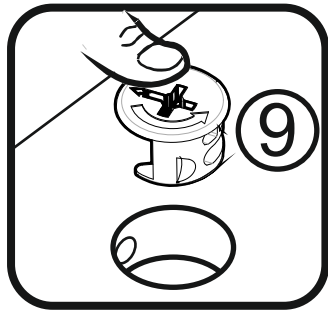
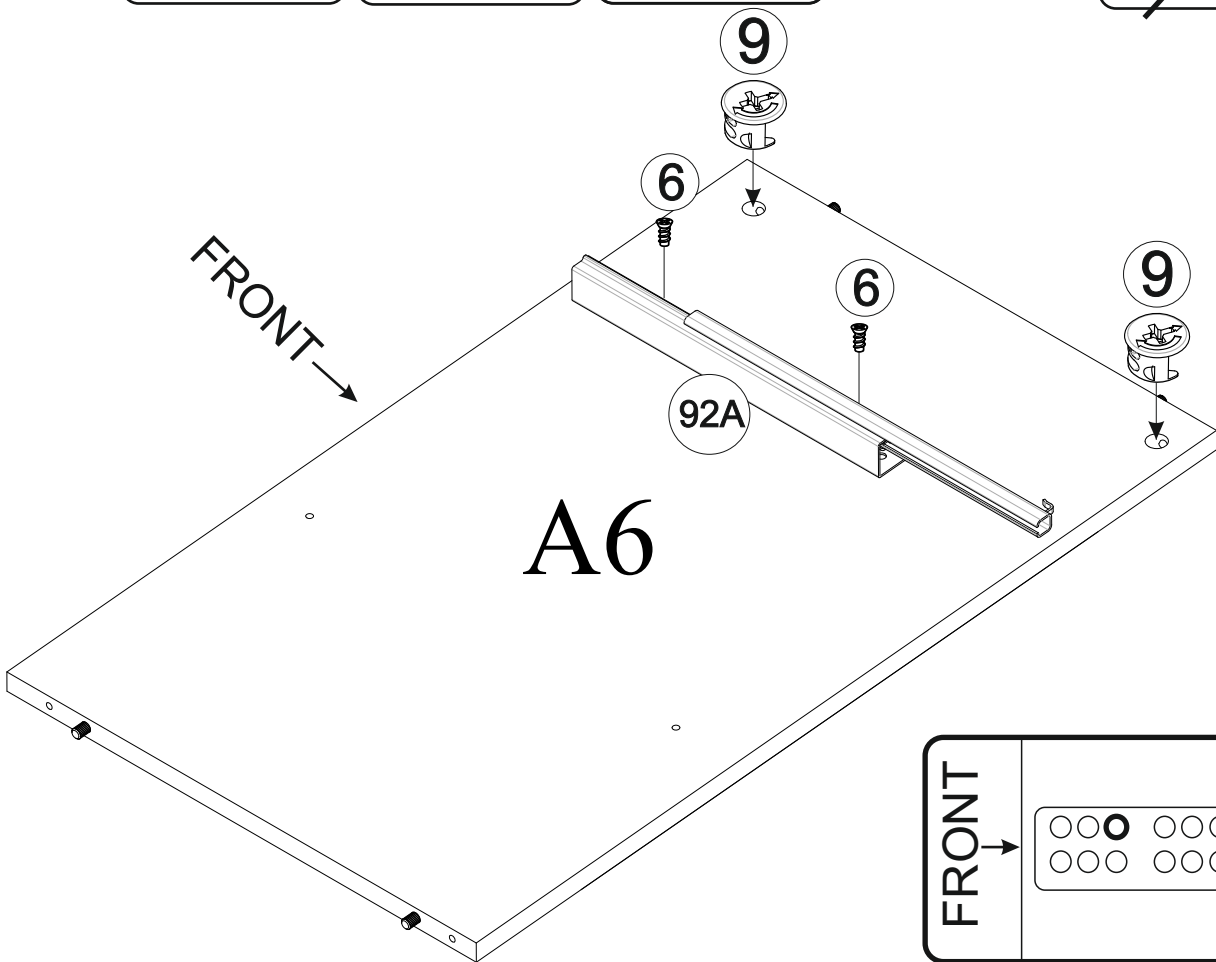
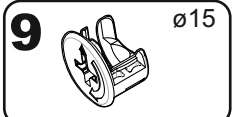
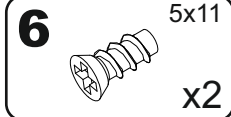

8

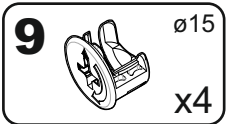
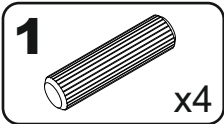

A20 808x426

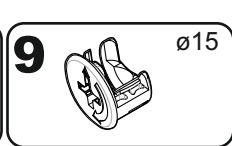
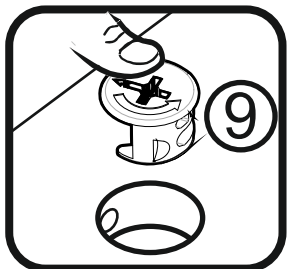
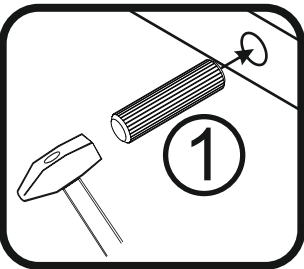
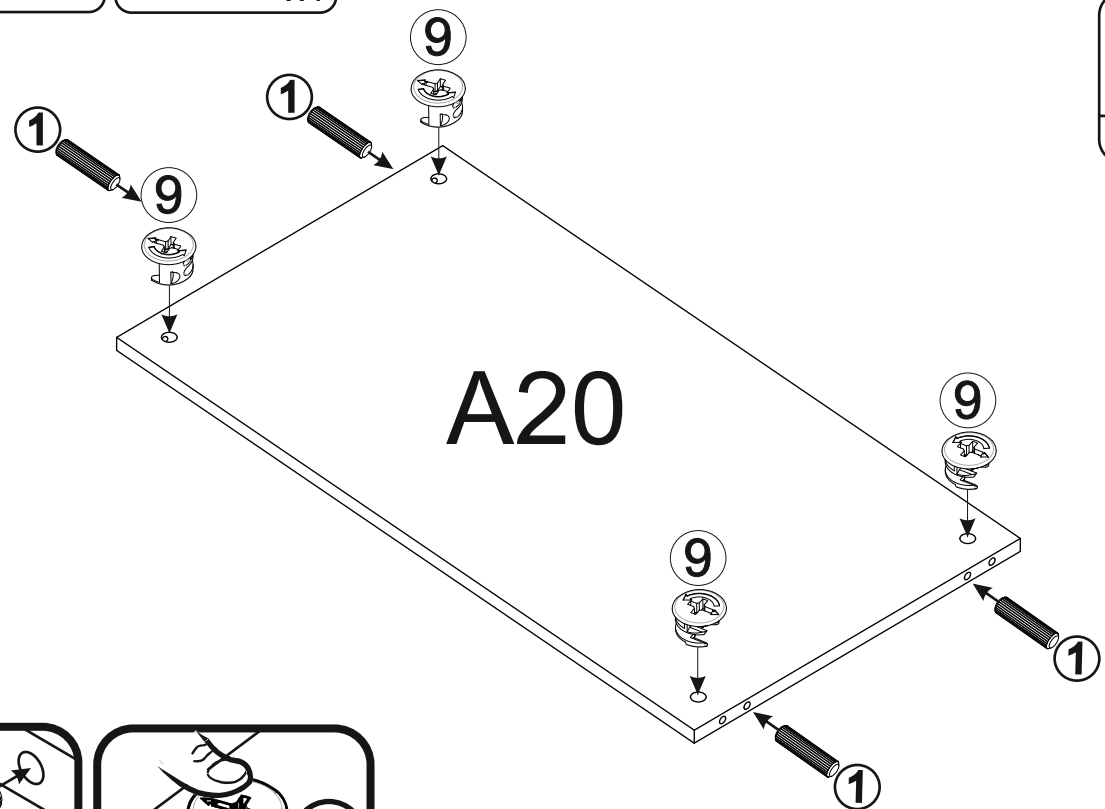
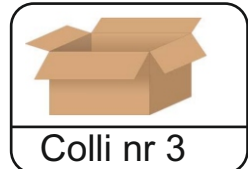

9 **54W** $\varnothing 35$
x4

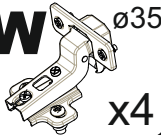

6 5x11
x8

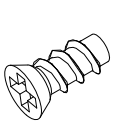

A41 546x490

A42 546x490

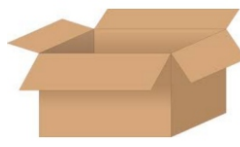

Colli nr 1

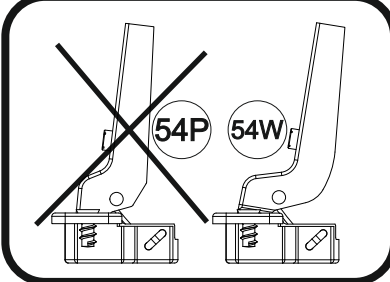
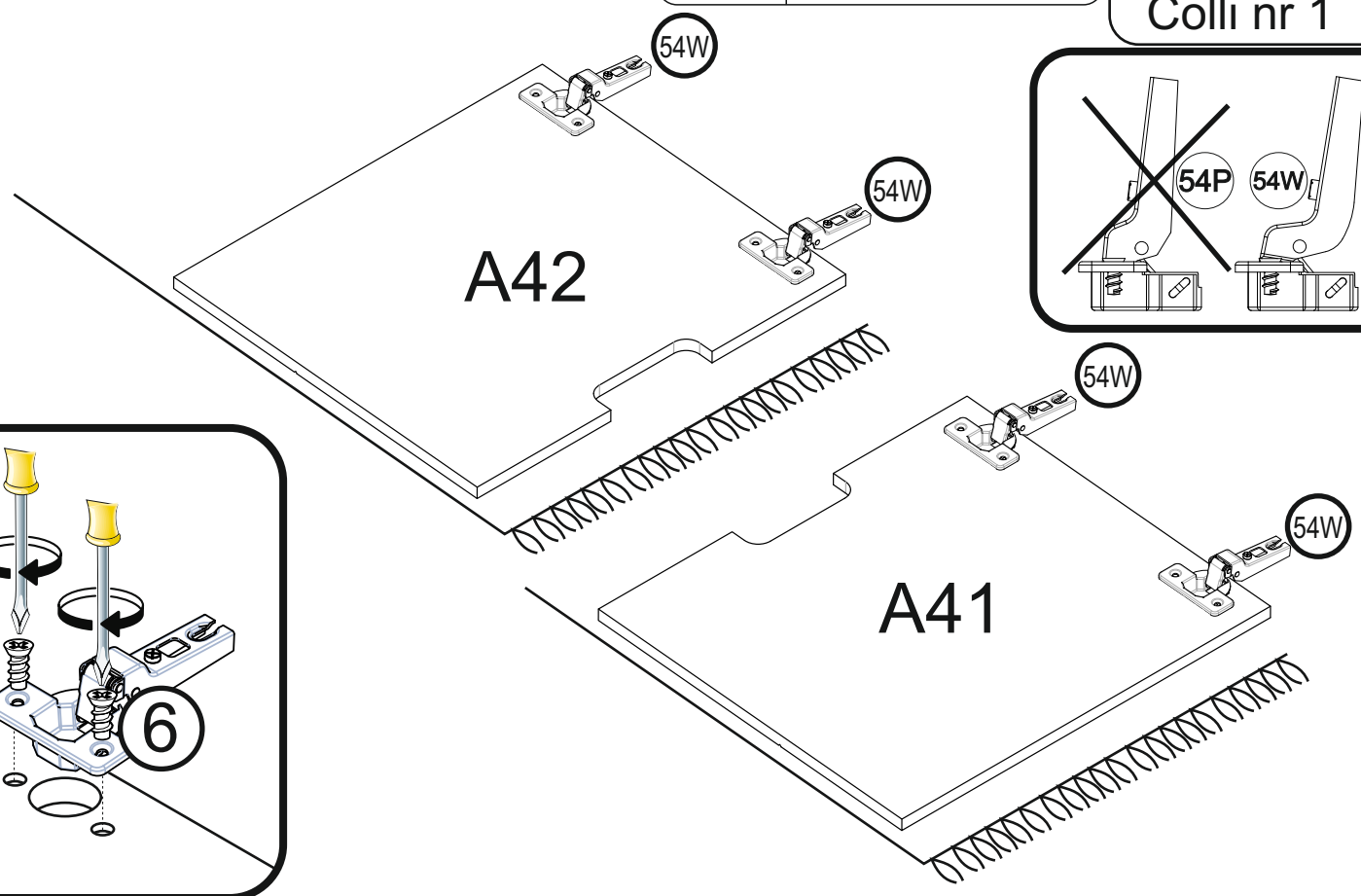
10 **54P** $\varnothing 35$
x4



6 5x11
x8

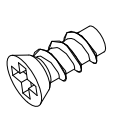

A43 404x490

A44 404x490

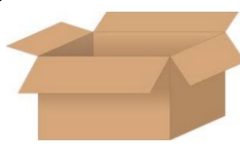

Colli nr 1

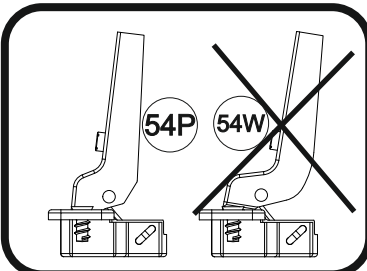
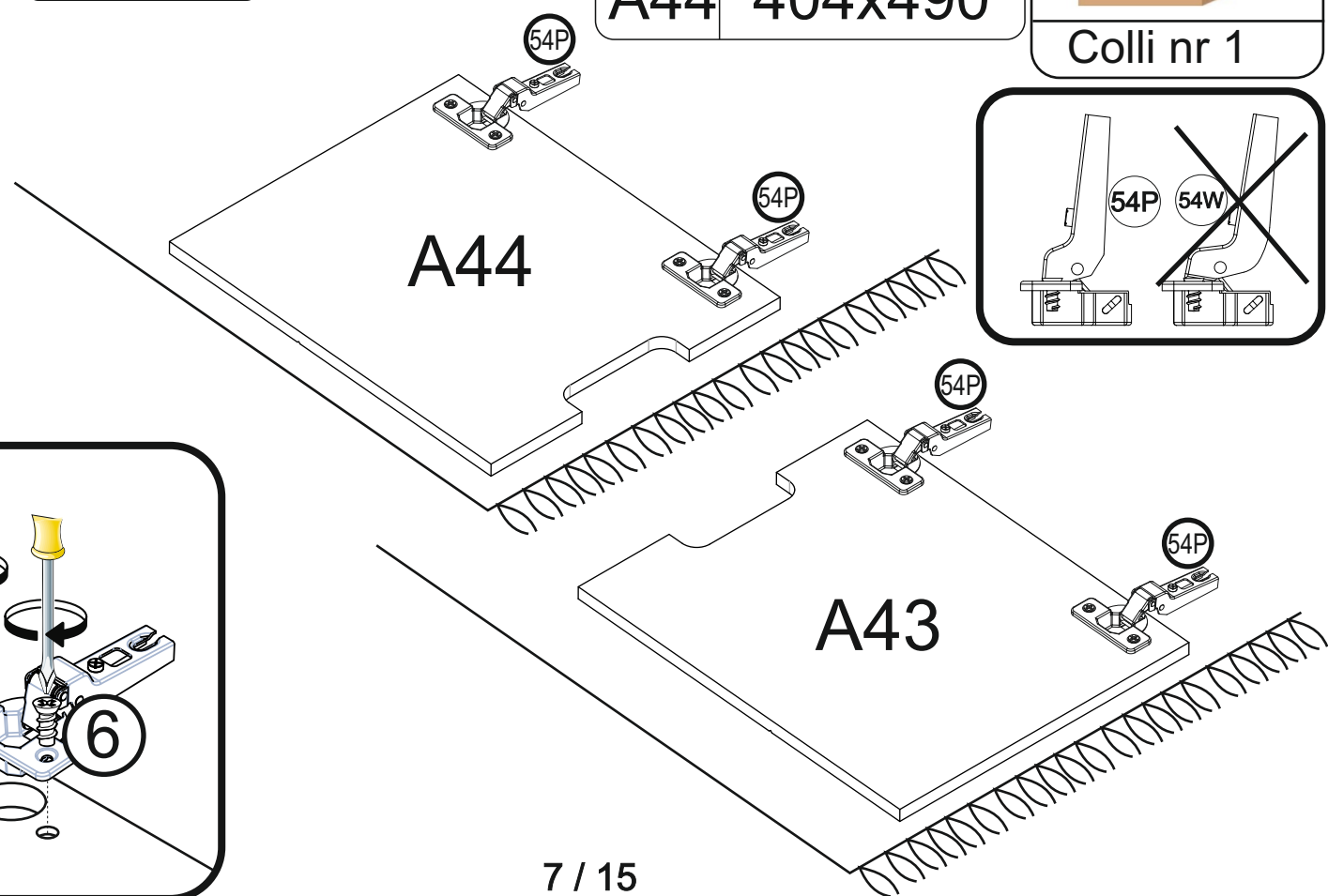
11

2

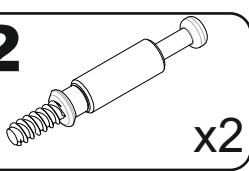

x2

AS1 546x195

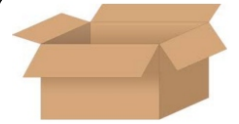

Colli nr 1

2

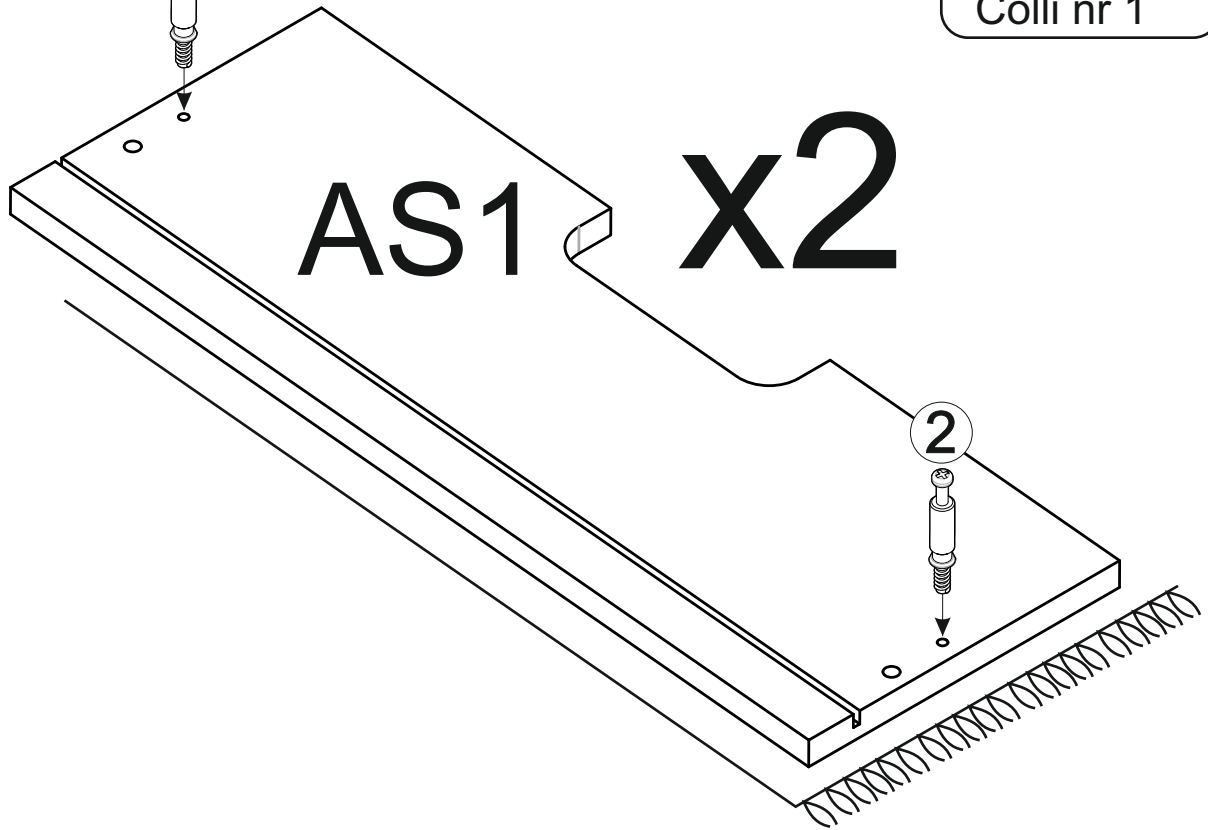

AS1 x2

2

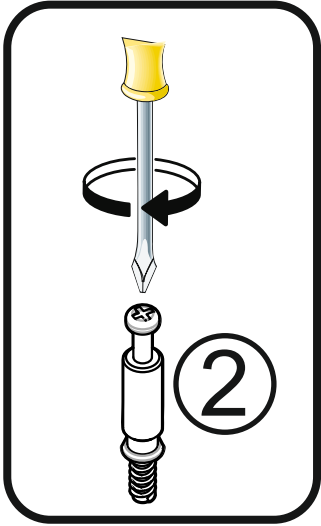

2

12

x2

1

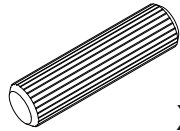

x4

22



x2

24



ø12

x2

AT1 507x82

WQ1 400x96

WQ2 400x96

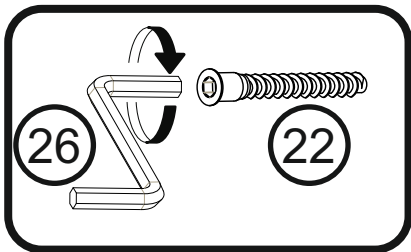

26

22

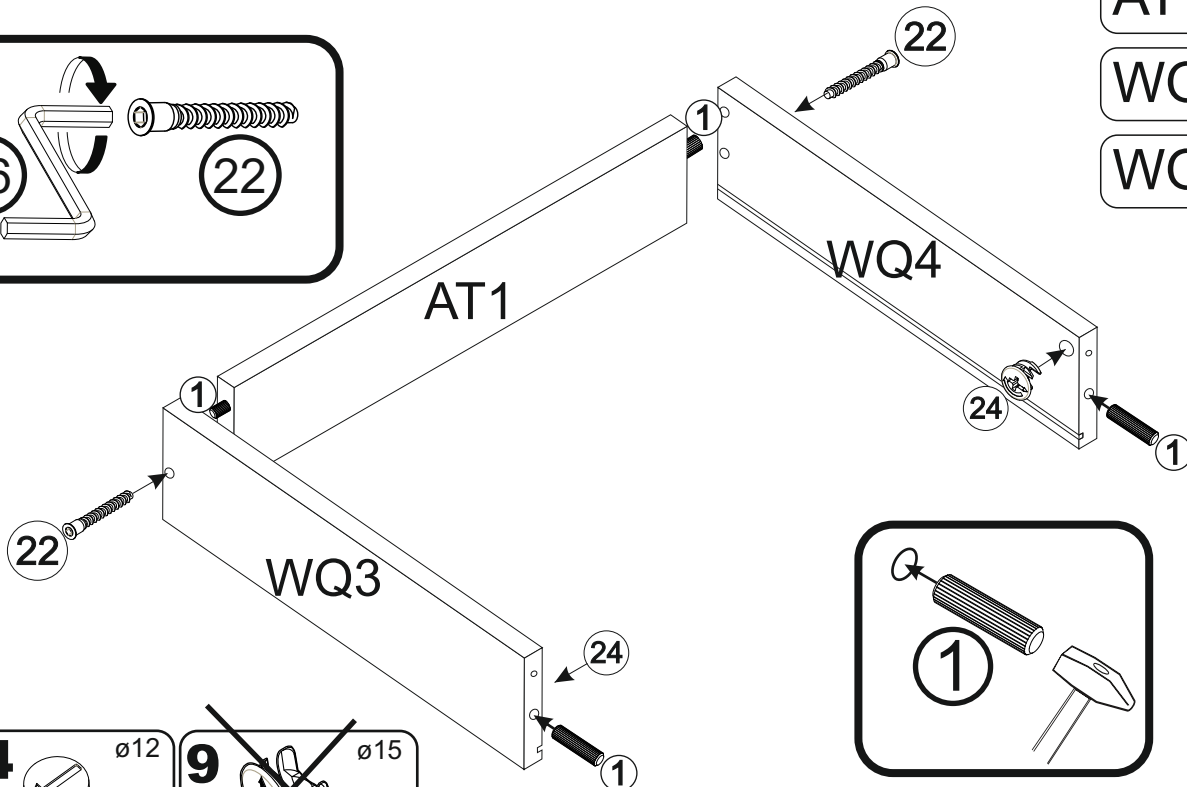

AT1

WQ4

WQ3



Colli nr 1

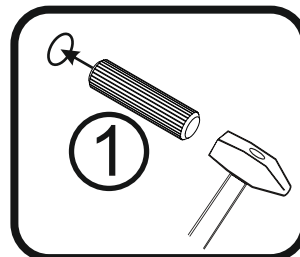

1



24



24

ø12



~~**9**~~

~~ø15~~

13

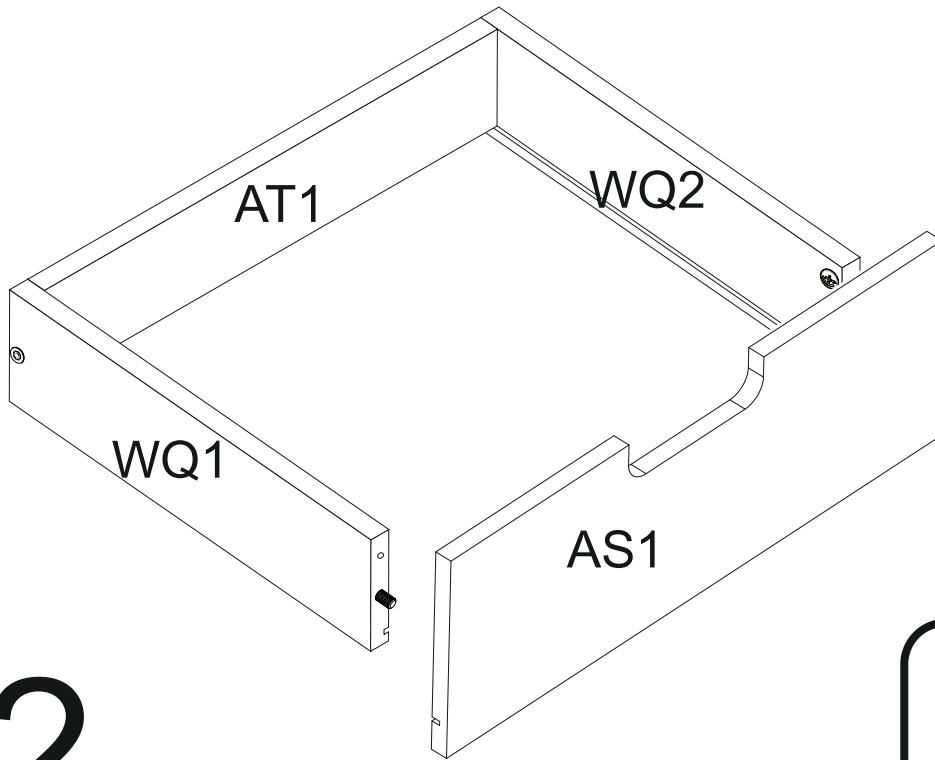

x2

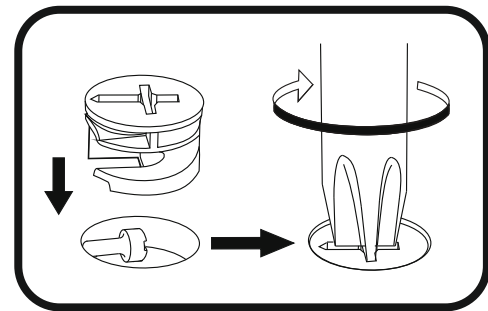

14

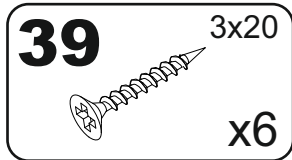
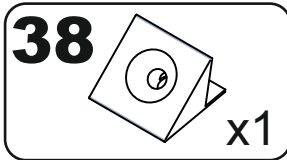

AD1 517x403

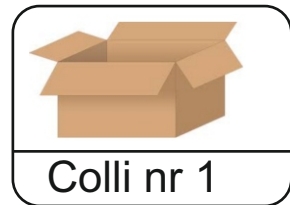

x2

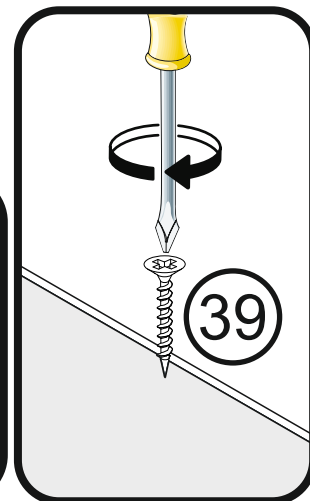
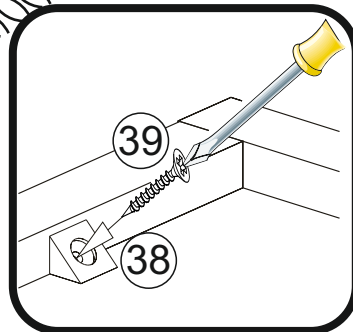
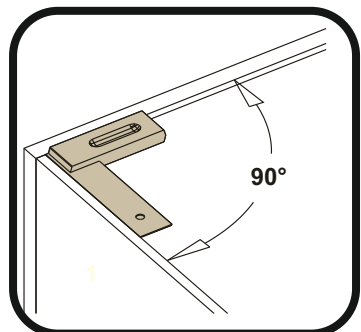
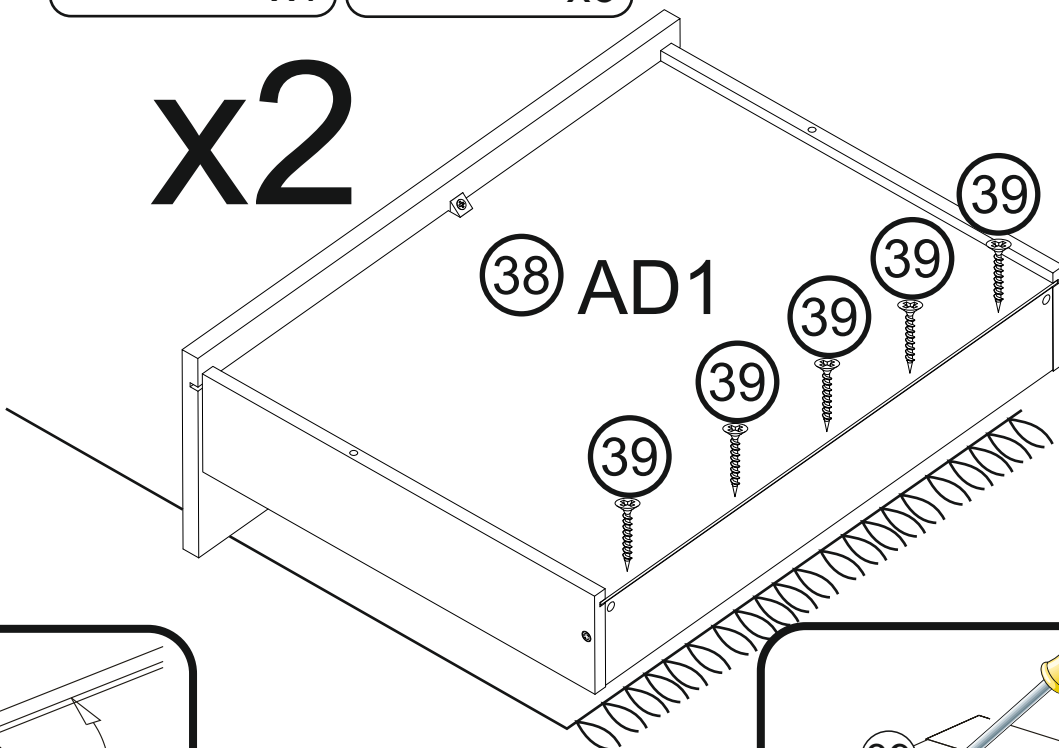

15

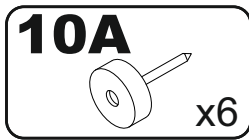
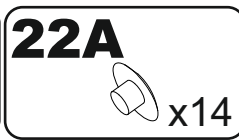
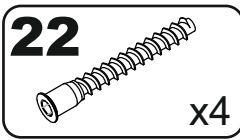

A61 360x80

A62 1768x80

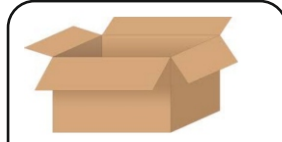

Colli nr 2

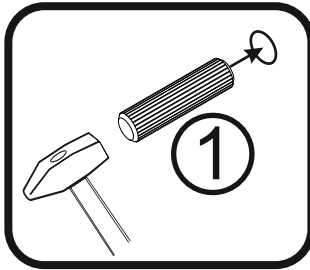
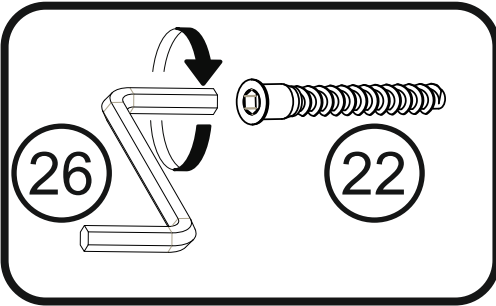
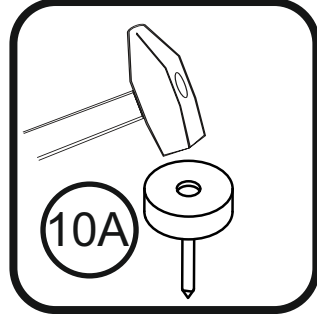
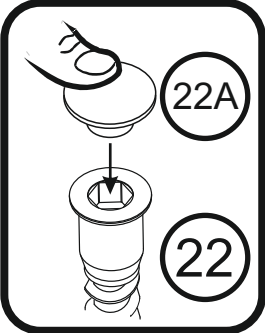
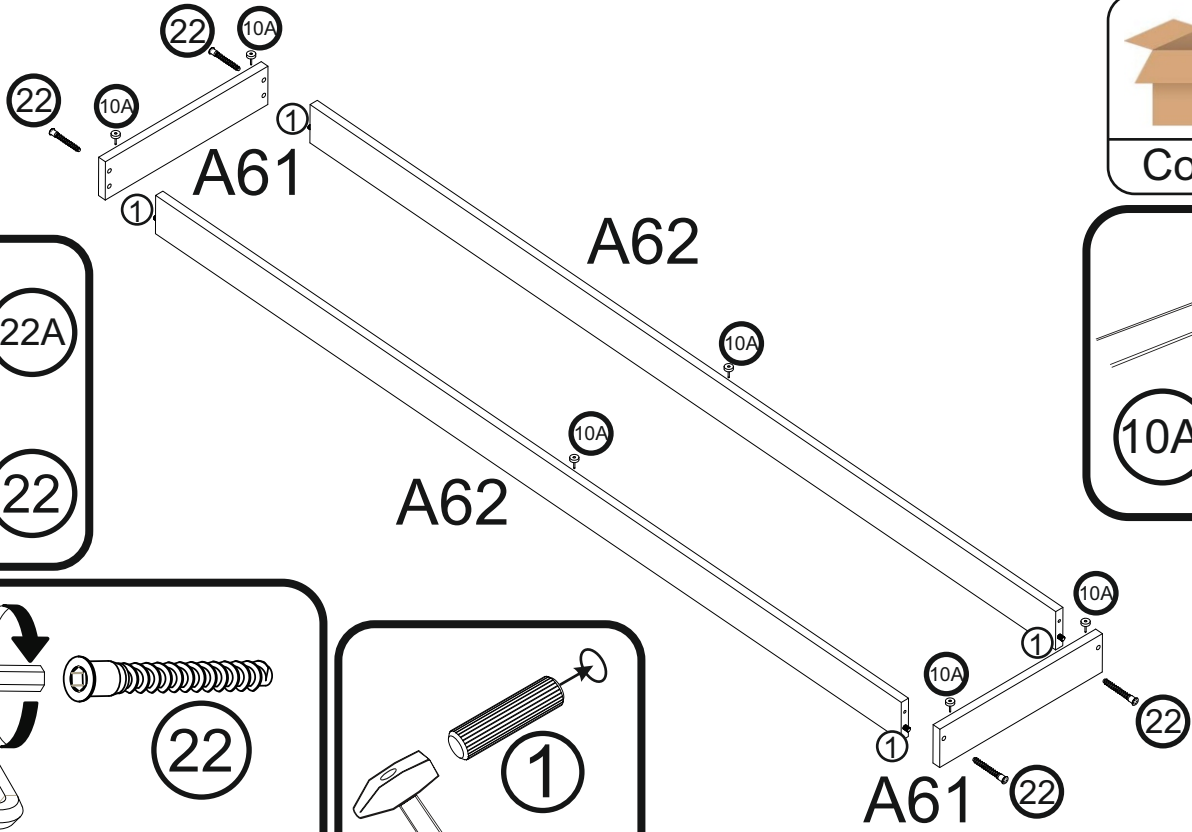

16

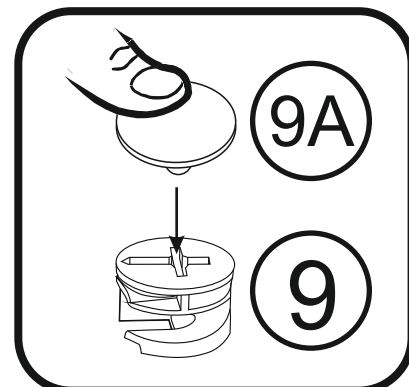
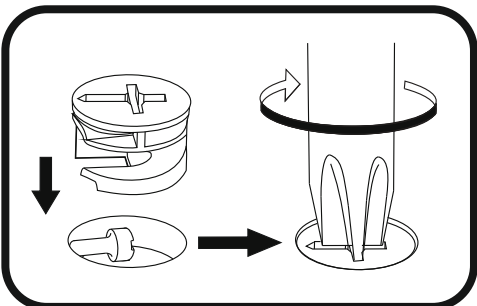
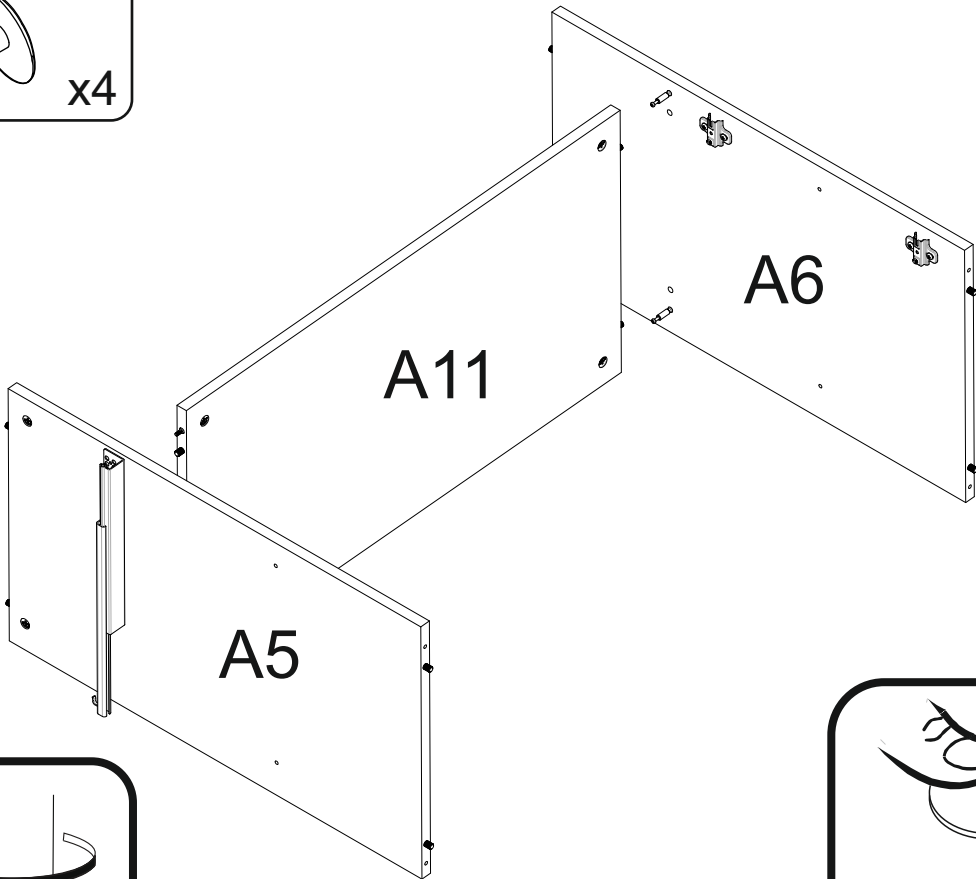
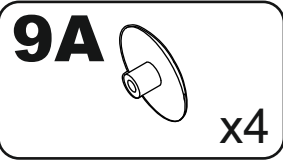

17

22

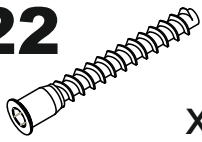

x8

22A



x8

A01

1980x450

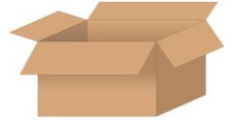

Colli nr 2

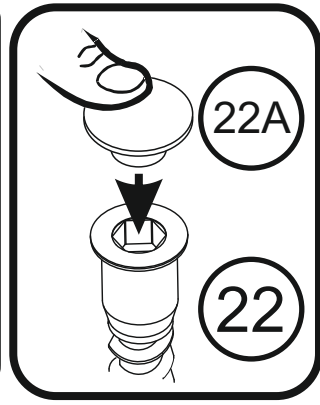
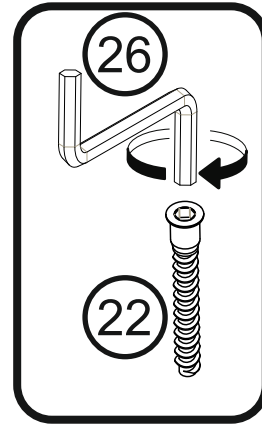
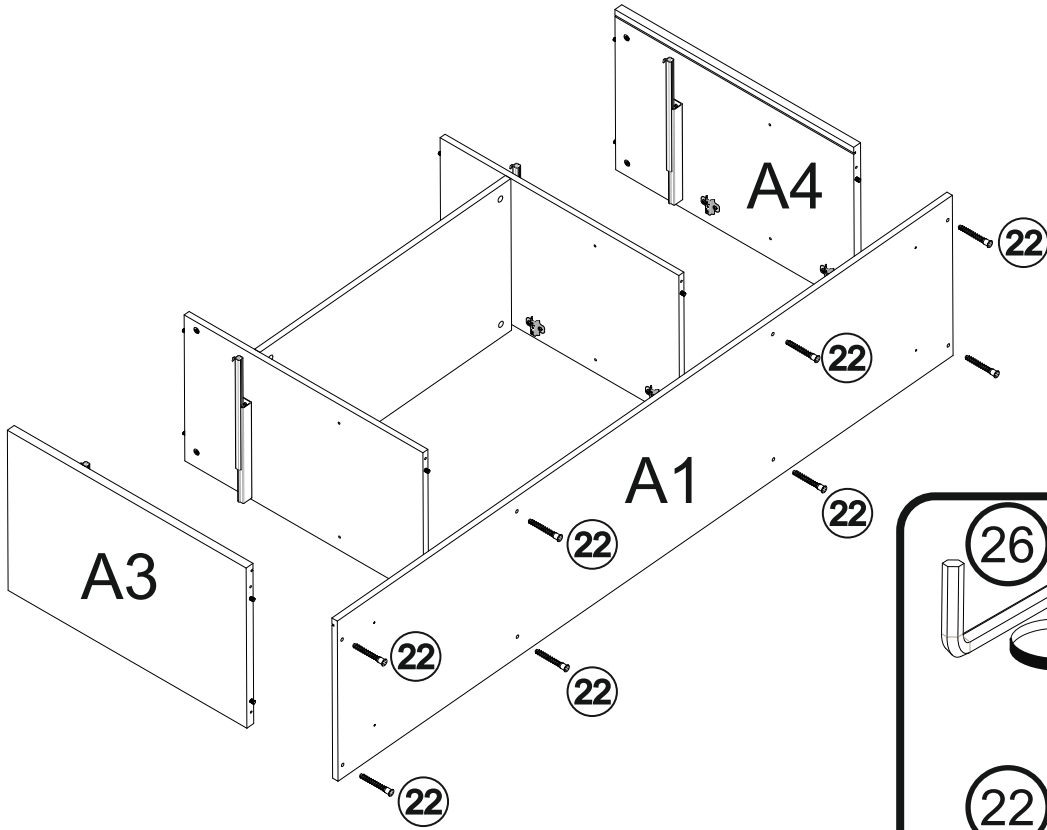

18

60

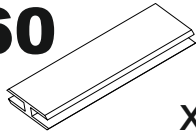

x1

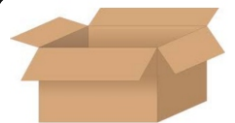
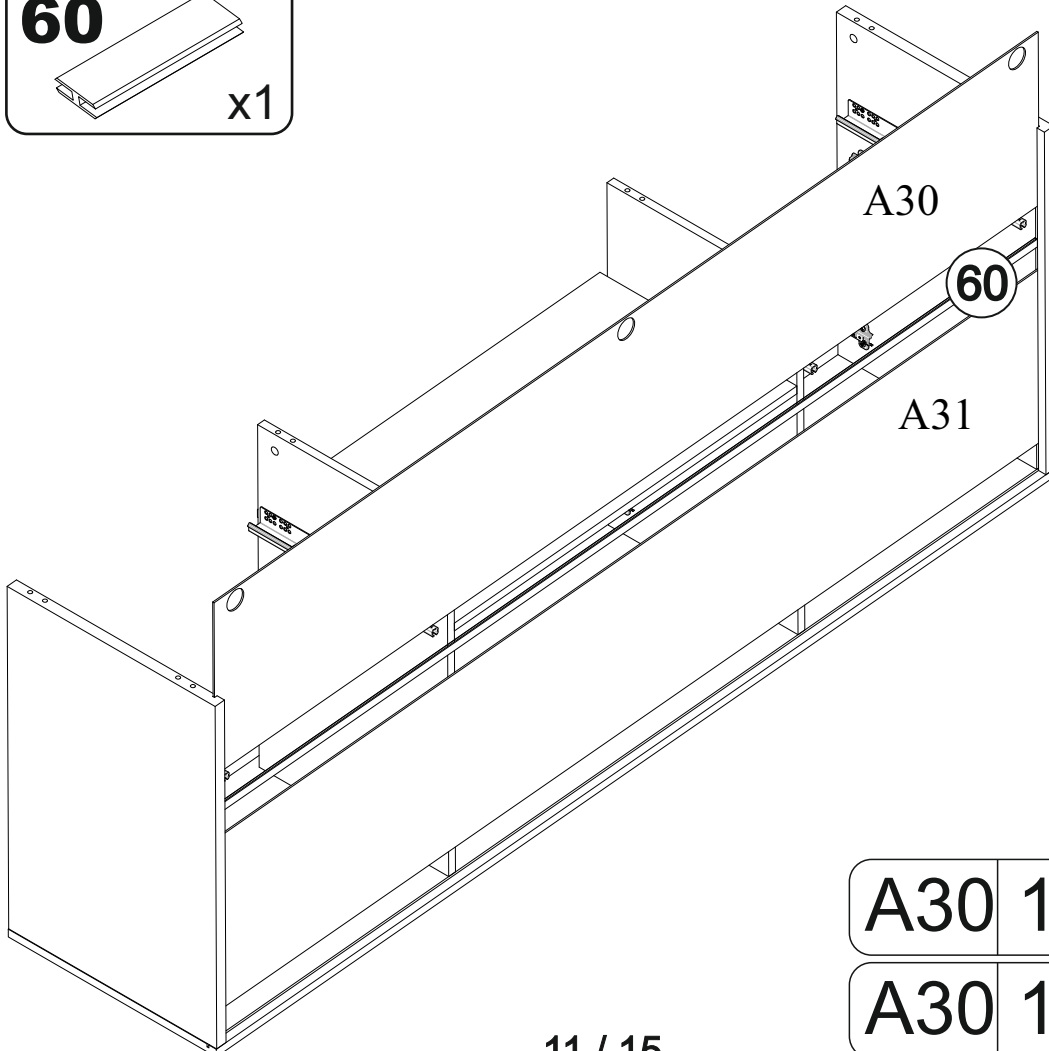

Colli nr 2

A30

1944x356

A30

1944x356

19

9A



x8

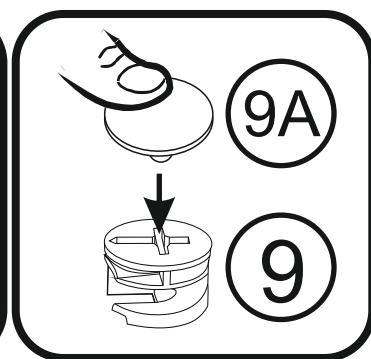
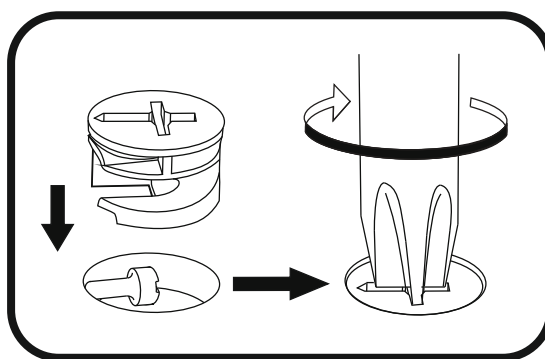
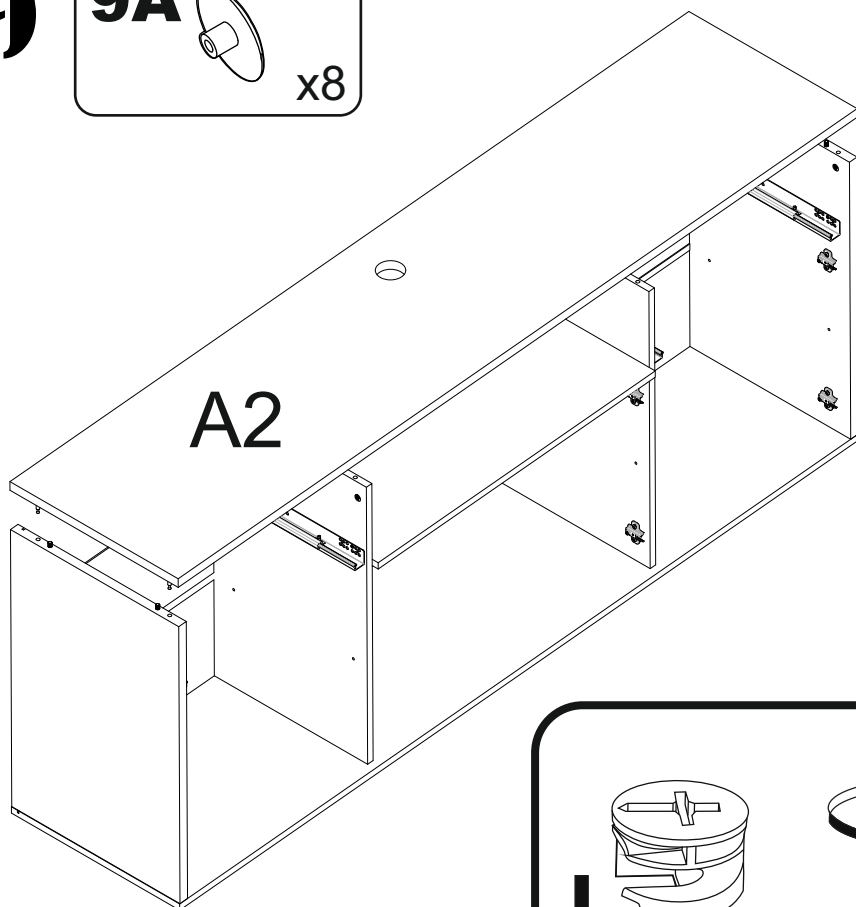

20

38

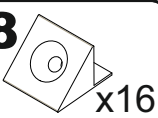

x16

39

3x20

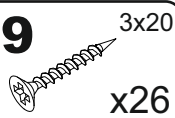

x26

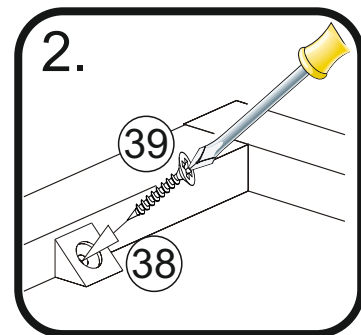
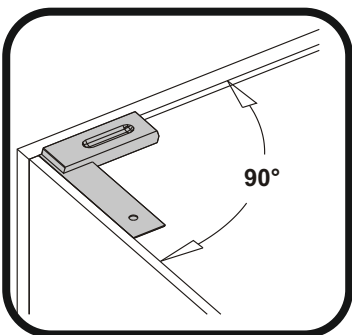
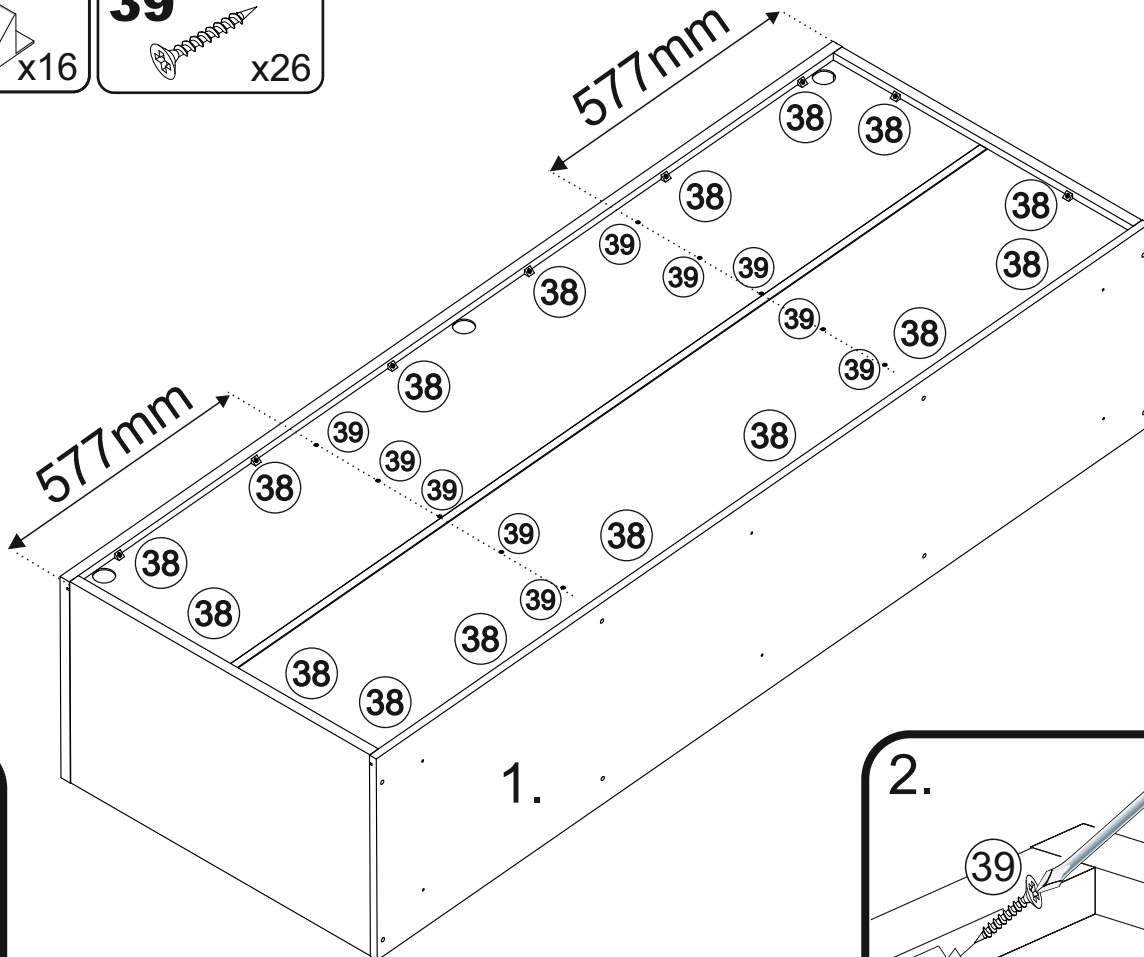
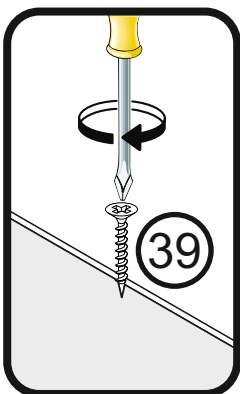

21

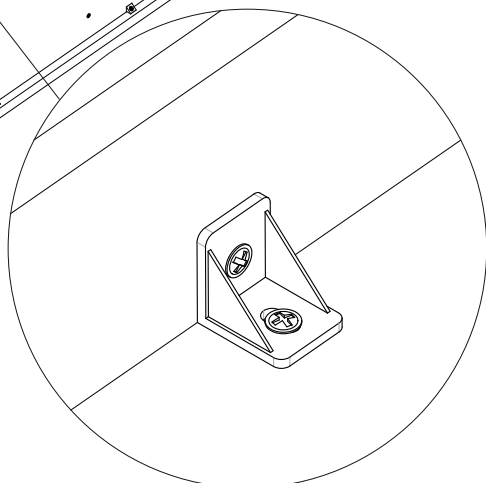
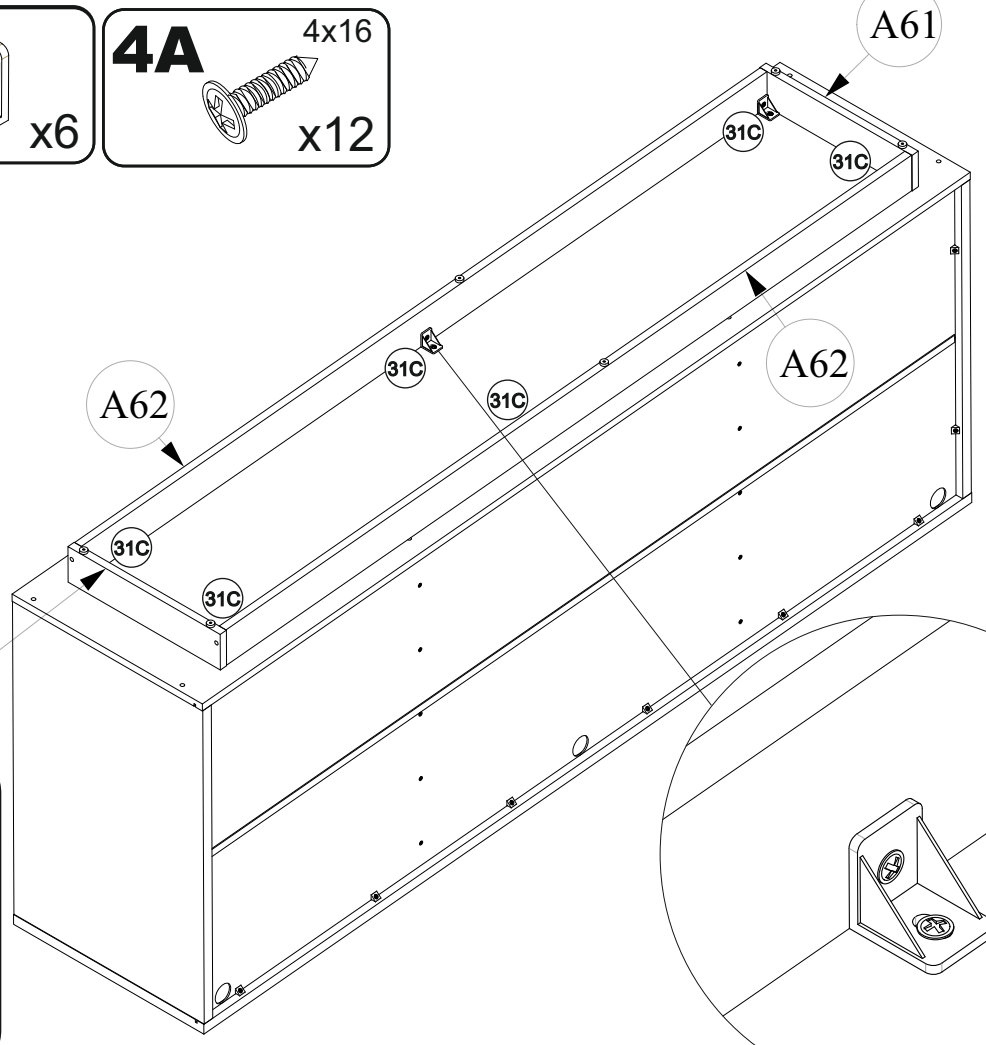
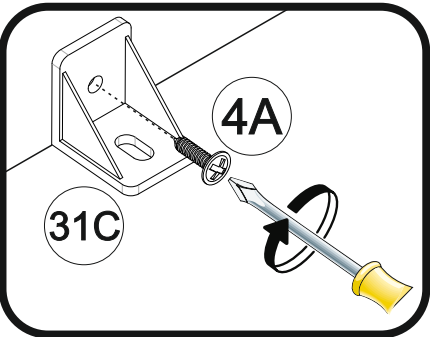
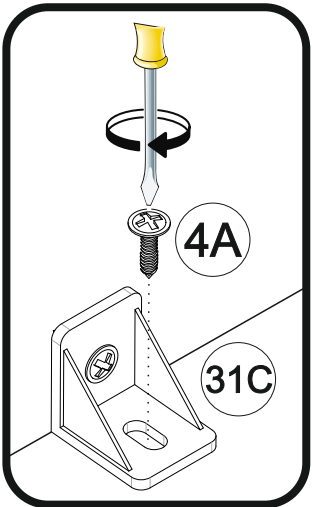
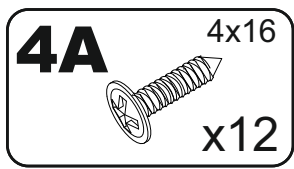
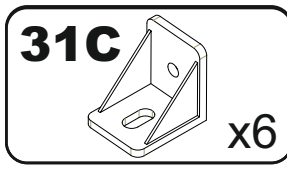

22

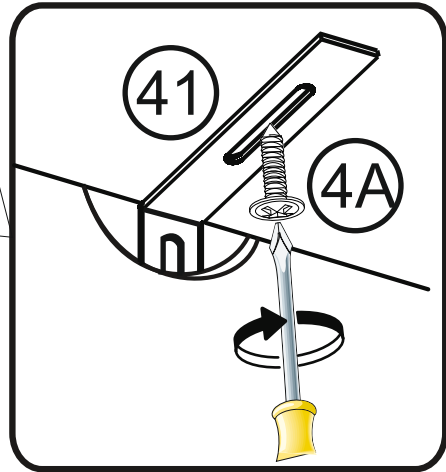
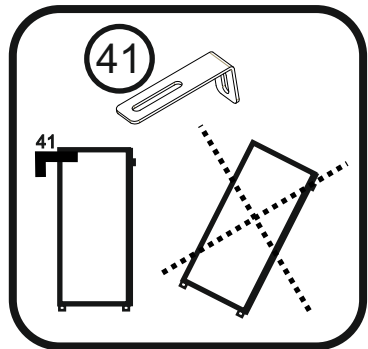
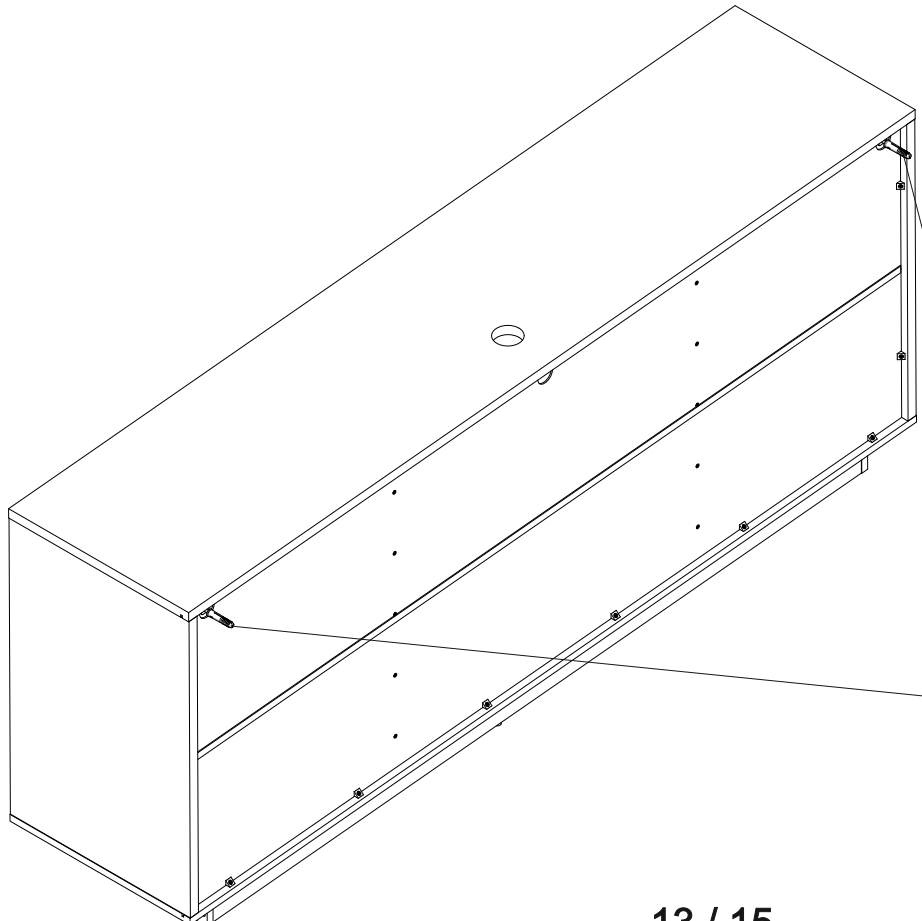
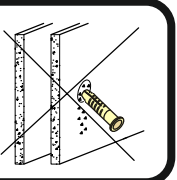
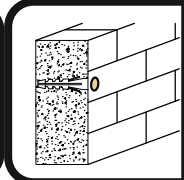
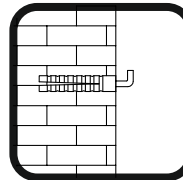
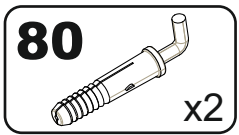
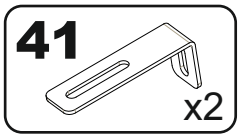
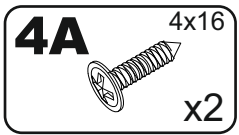

23

13

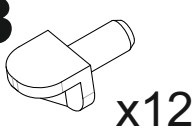

x12

x2 A10 547x400



Colli nr 1

A11 808x400

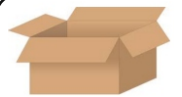

Colli nr 3

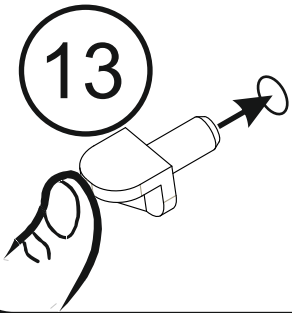
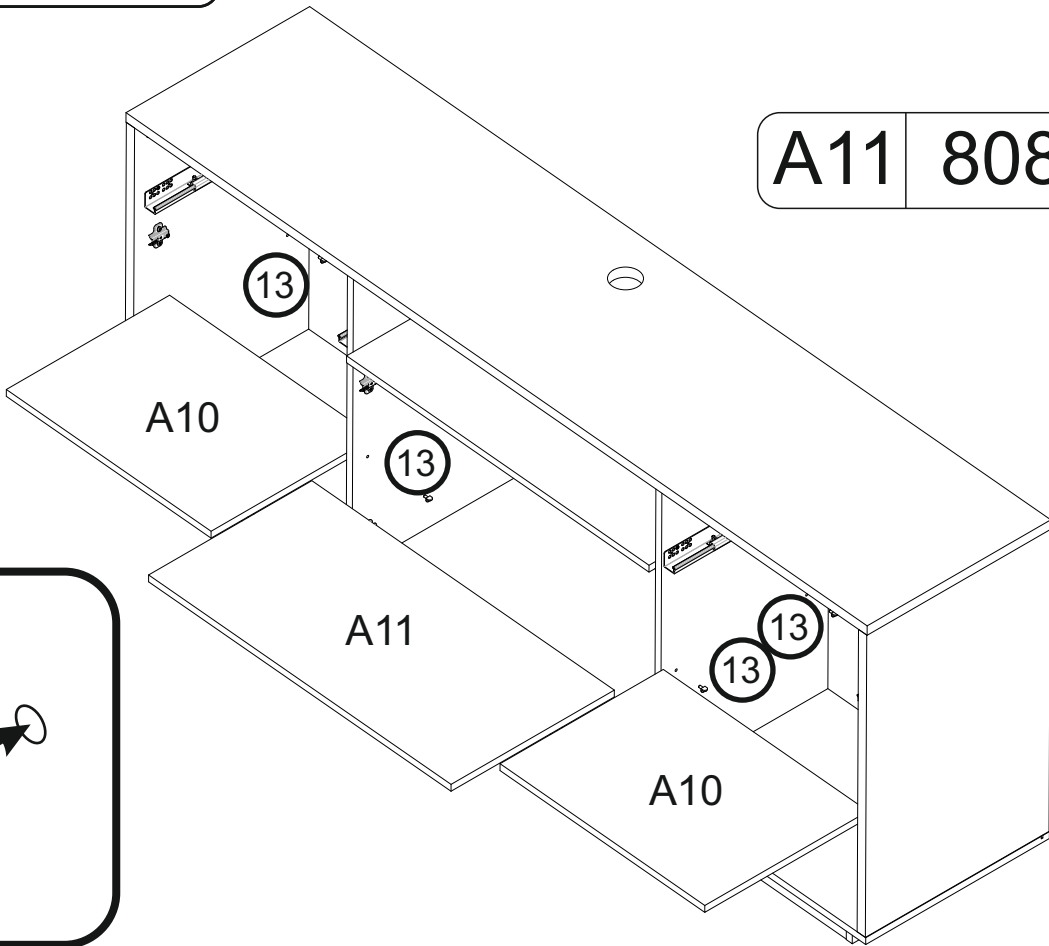

24

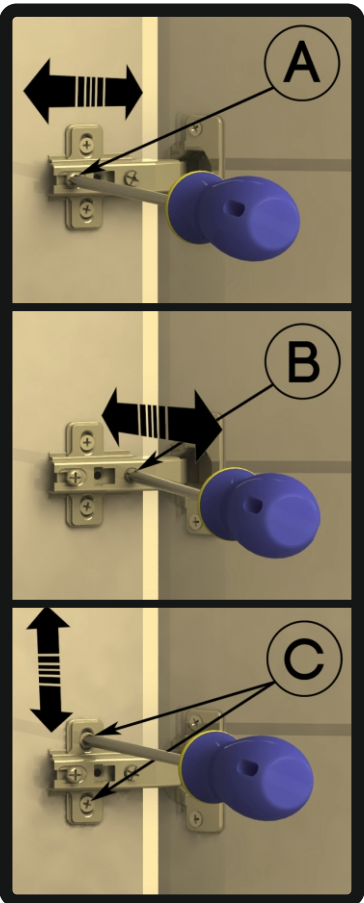
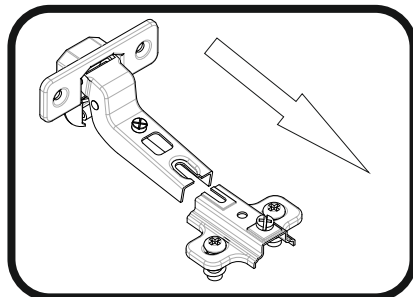
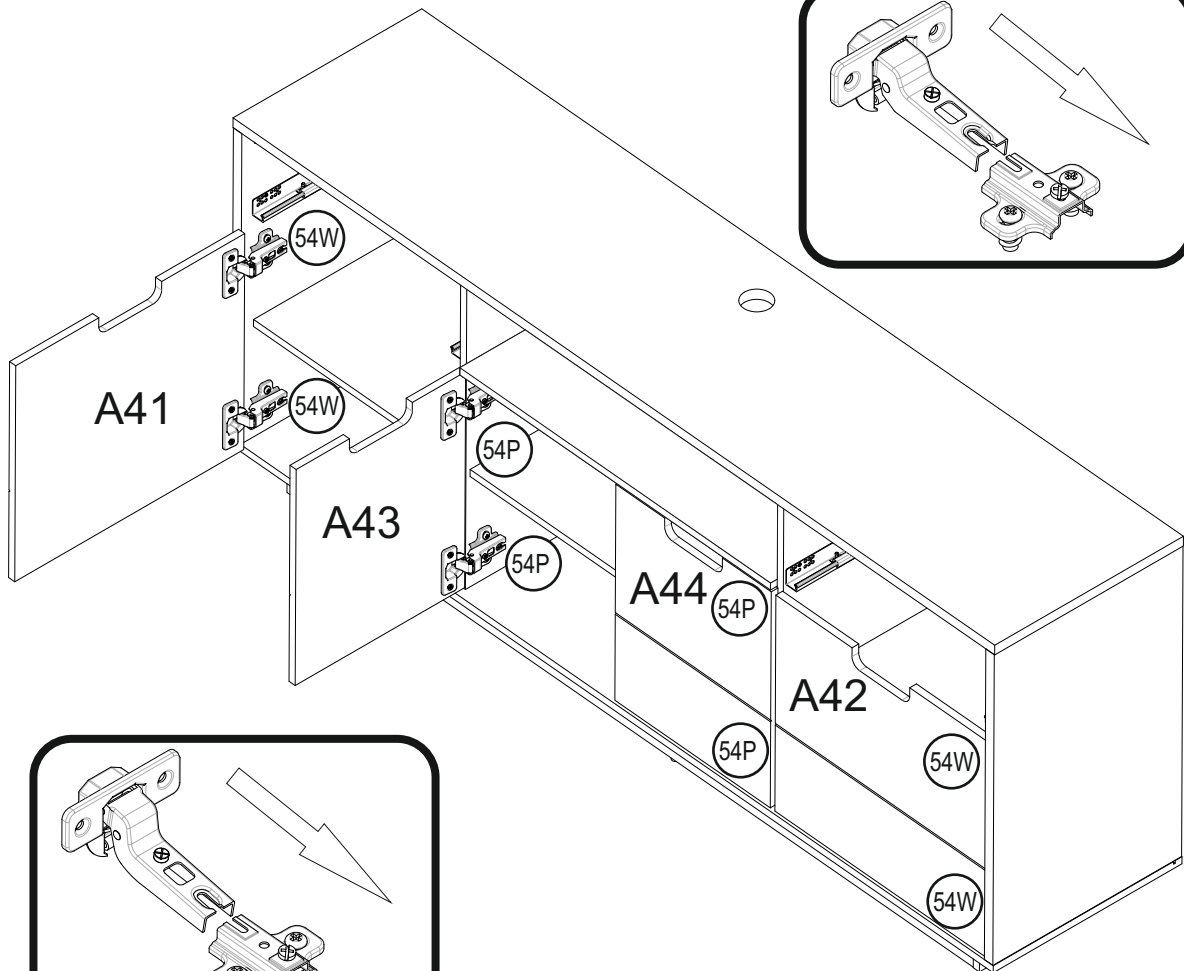
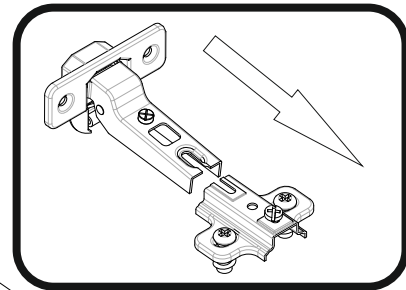

25

90

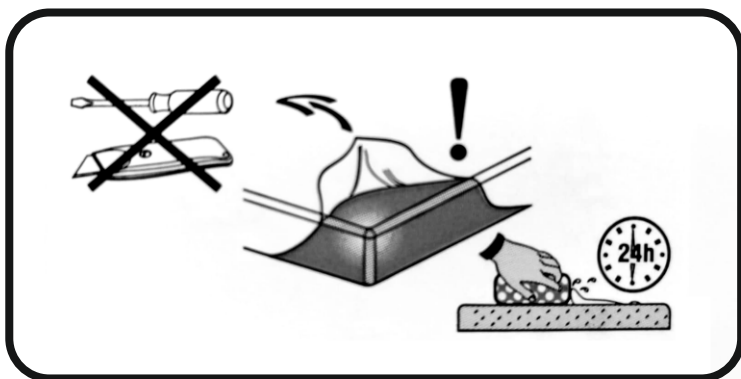
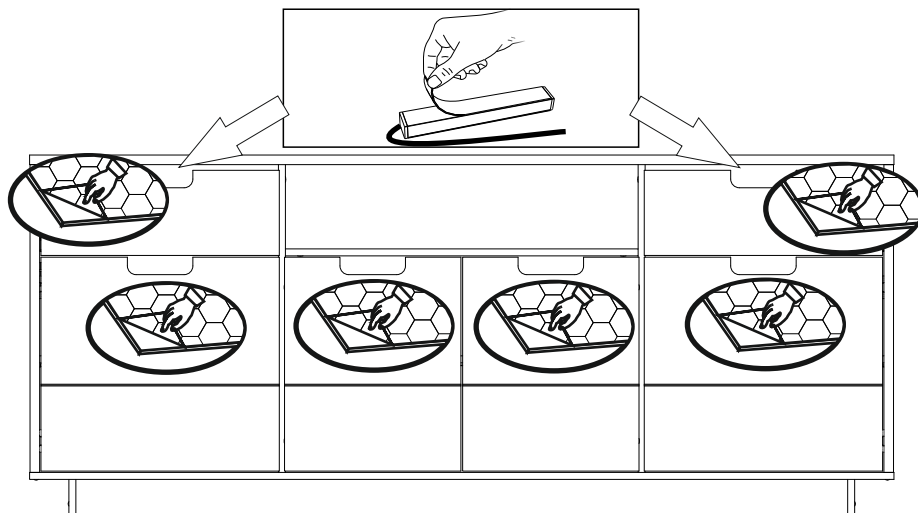
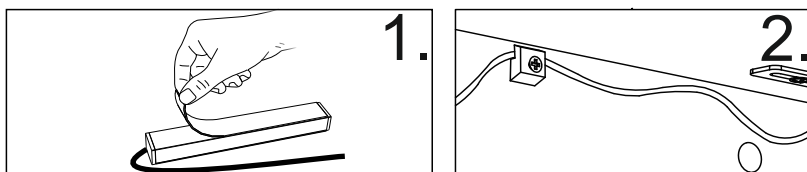
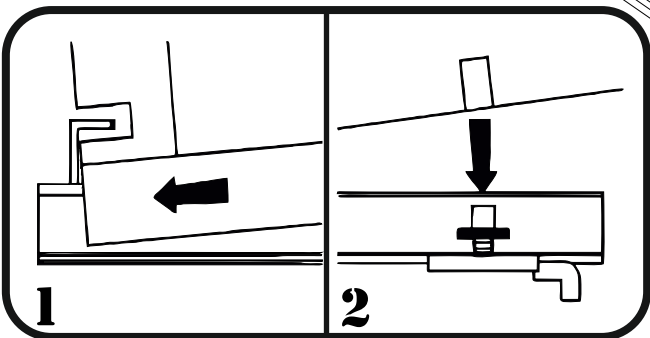
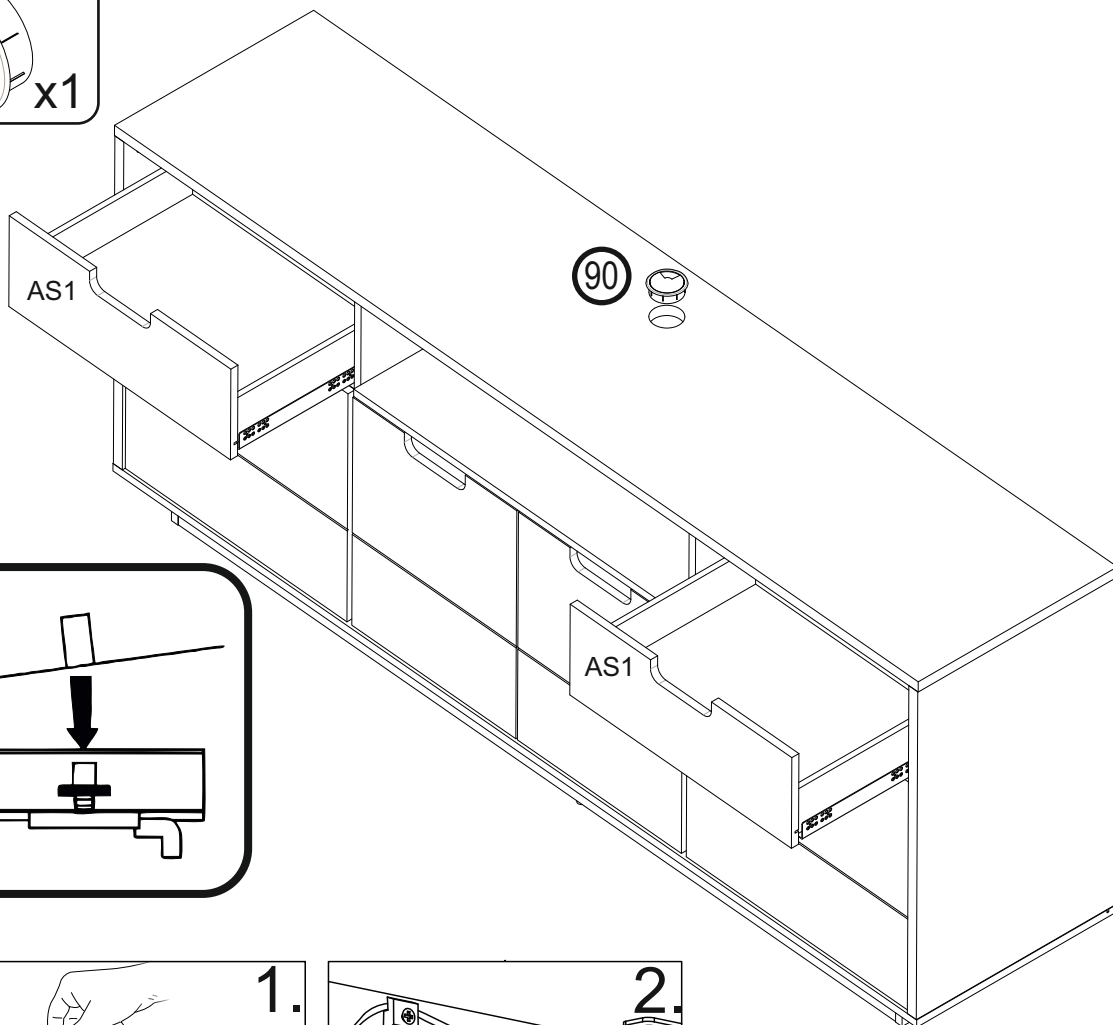
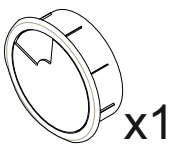

30 LED x1

39 3x20 x3

40 x3