

ASSEMBLY INSTRUCTION

ITEM NO.:20970051-01/02

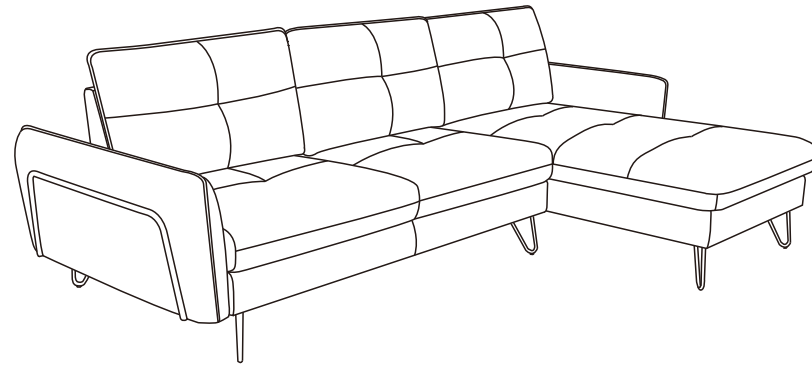

PARTS LIST

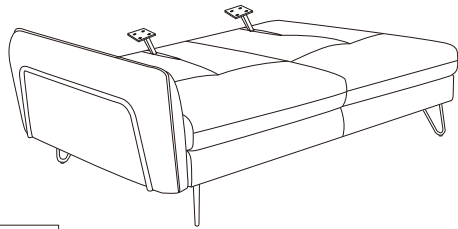

x1

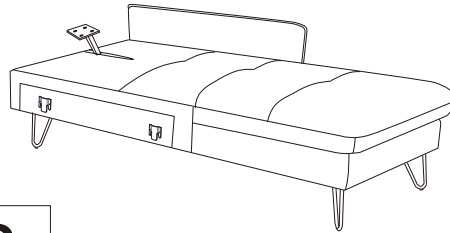

x1

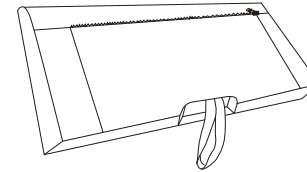

x3

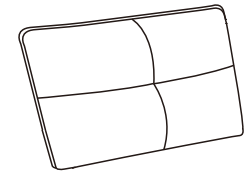

x3

A

B

C

D

HARDWARE LIST

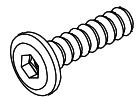

M6*20mm

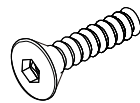

M6*20mm

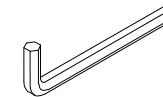
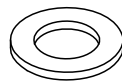

7*4CM

SPARE PART



M6*20mm

E x2

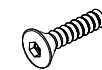

M6*20mm

F x2



G x4

E

x24

F

x12

G

x24

H

x8

I

x2

G x4

Step1

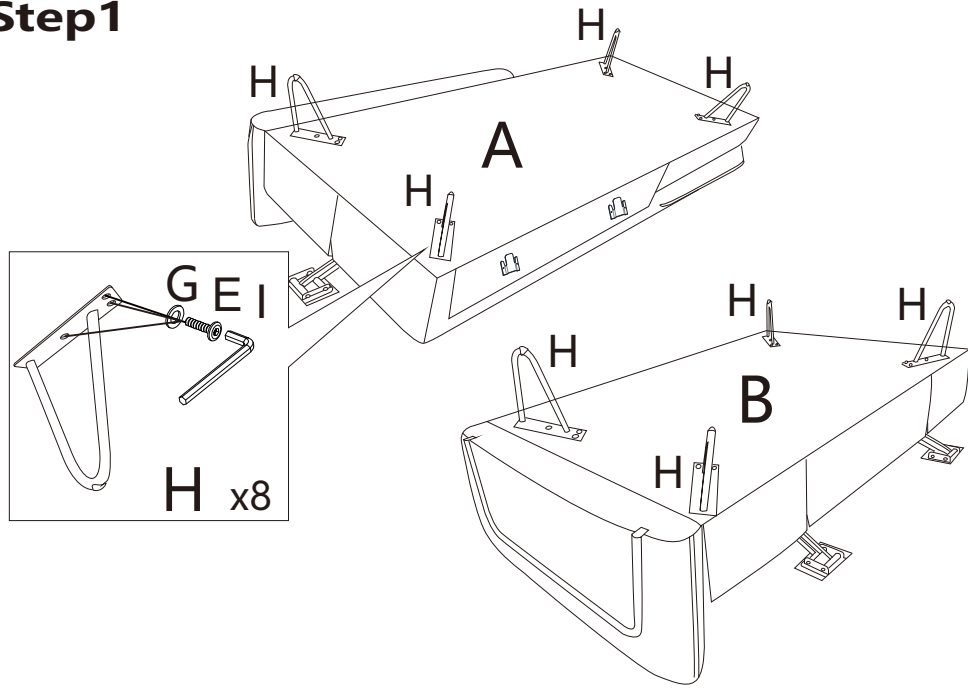

Step2

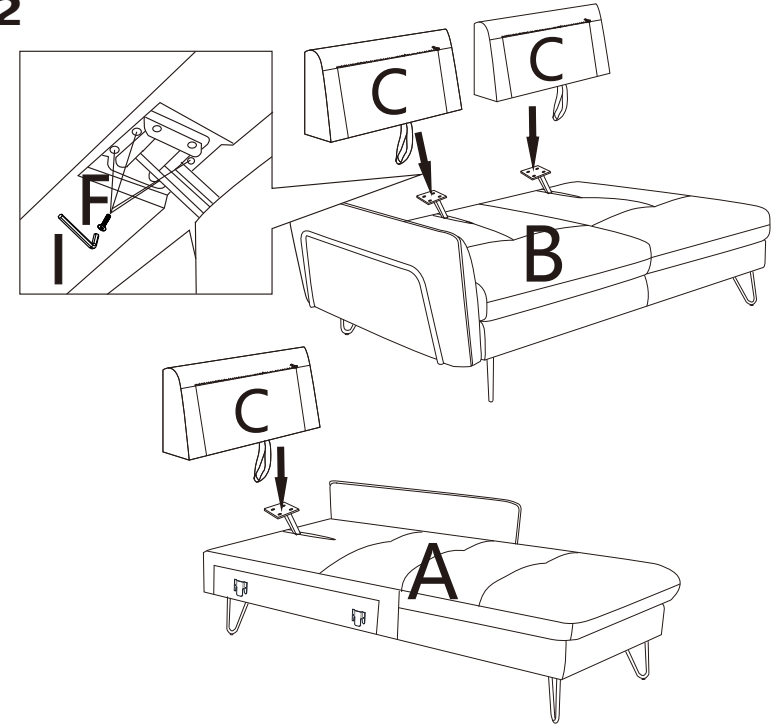

Step3

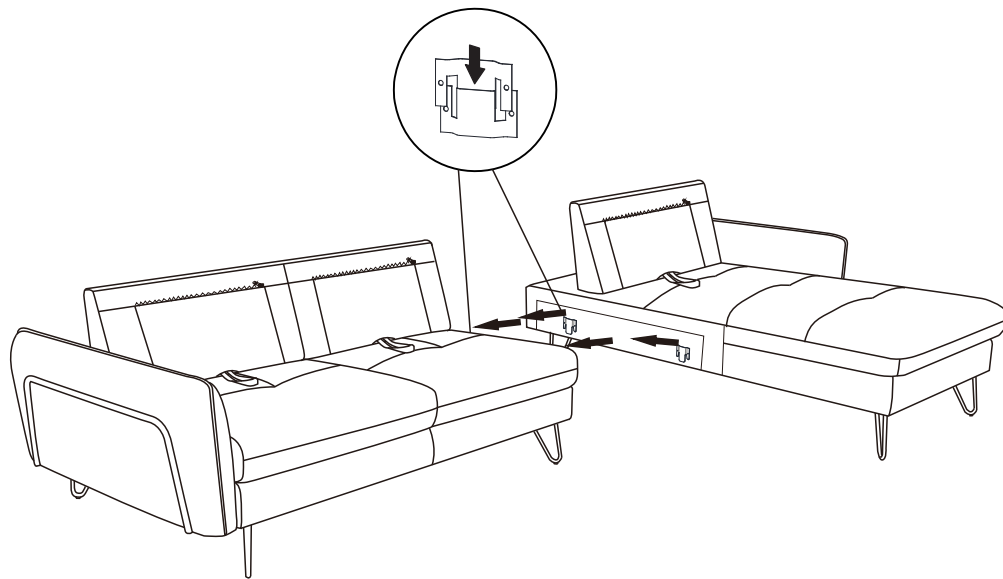

Step4

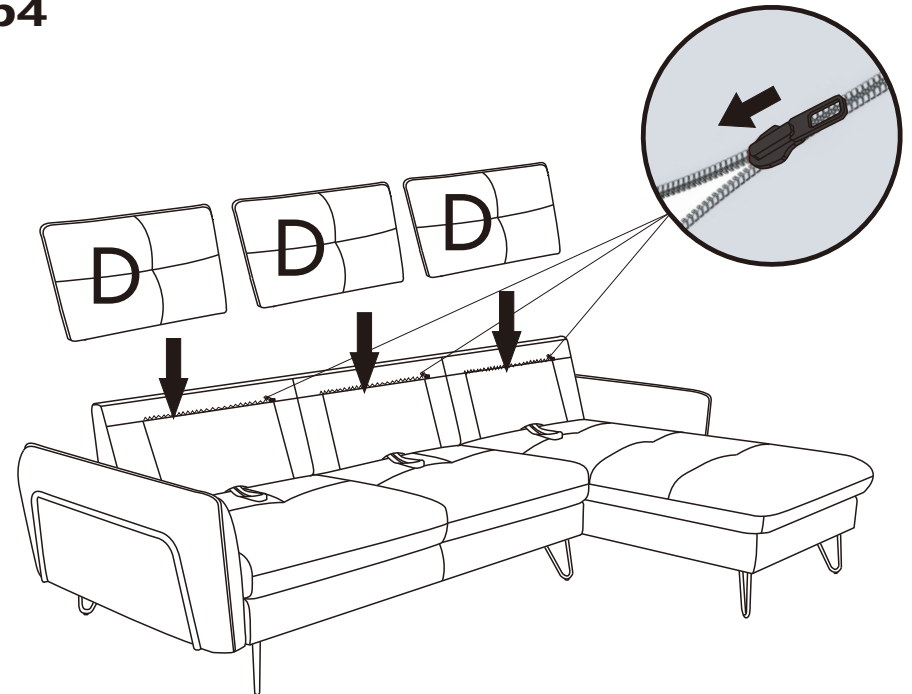

Step5

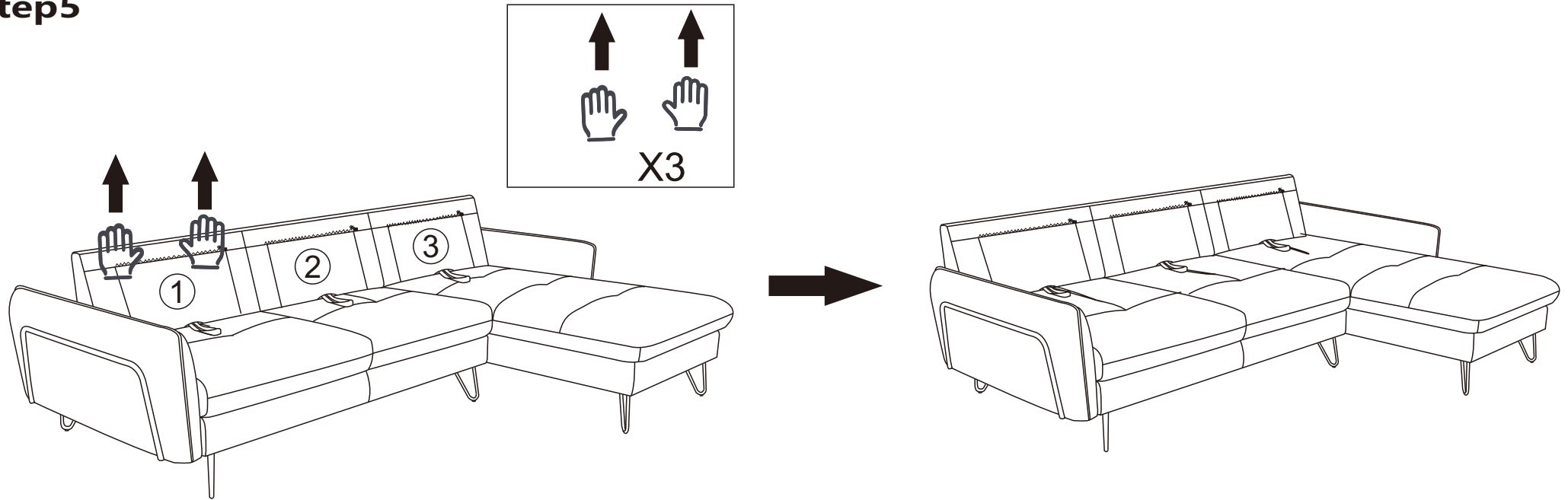

Step6

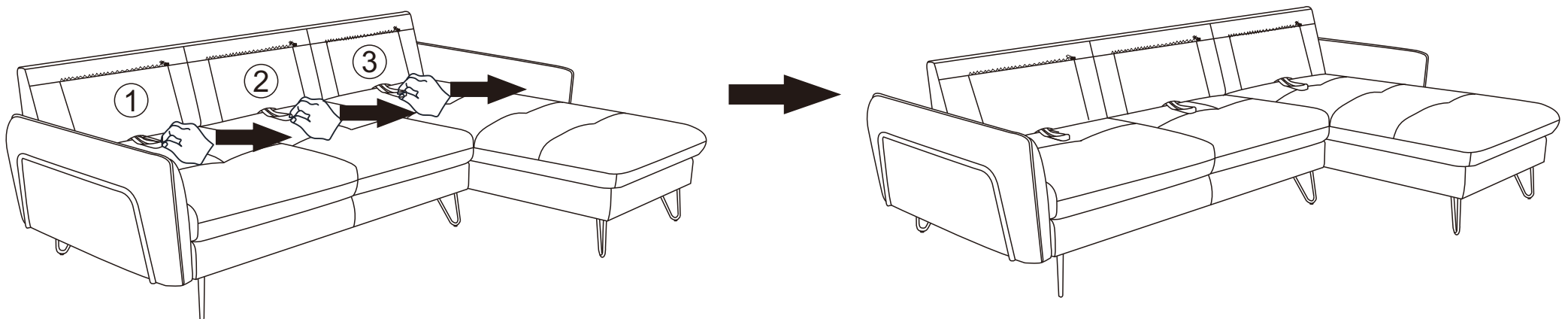

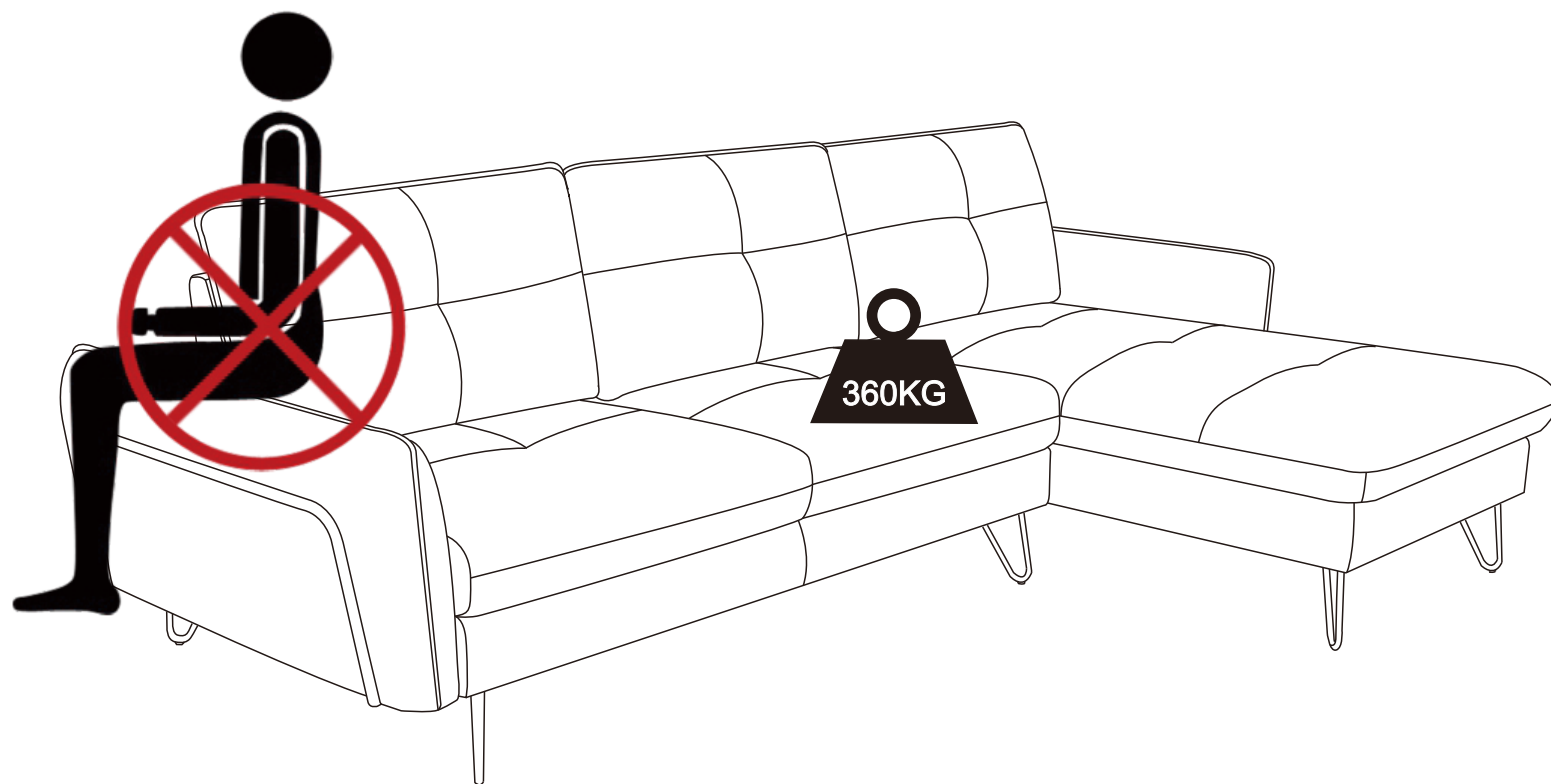

CUSTOMER INFORMATION

