

PROFI PFR03

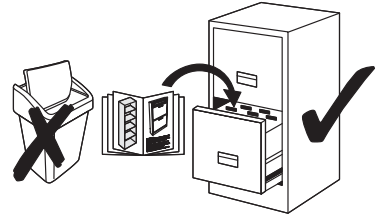
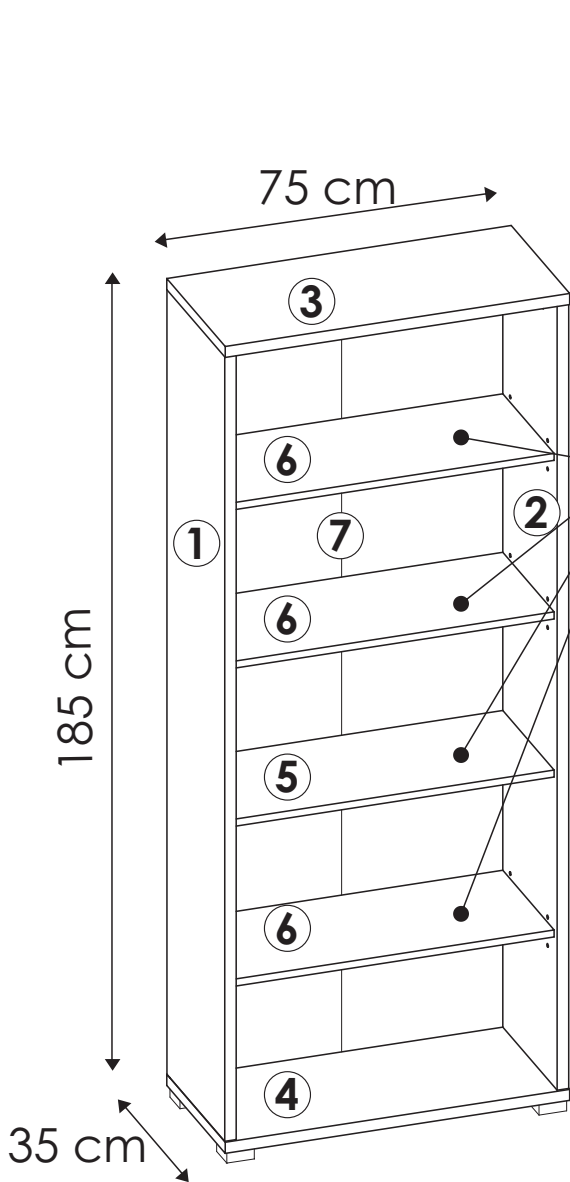

max. 5 kg

a1 8x35 x....(x12)	d6 x....(x12)	e0 x....(x8)	e1 x....(x8)	f1 x..(x8)
g2 7x60 x....(x4)	g0 x....(x4)	i2 4x16 x....(x1)	i11 4x30 x....(x8)	
m x....(x1)	o13 x....(x4)	q9 x....(x1)		
r4 x....(x10)	z x....(x1)			

- ① - C2
- ② - C2
- ③ - C1
- ④ - C1
- ⑤ - C1
- ⑥ - C1
- ⑦ - C2

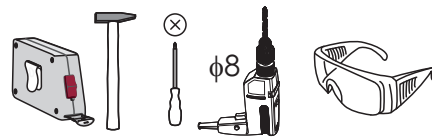
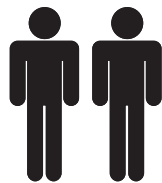
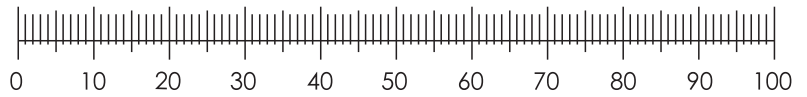
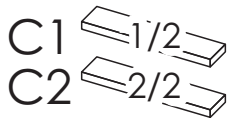

1

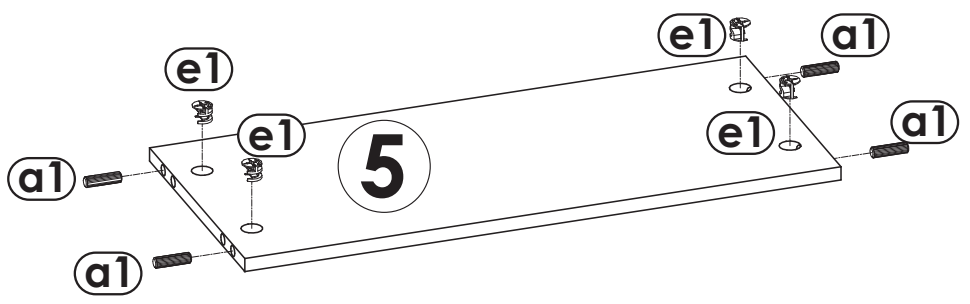
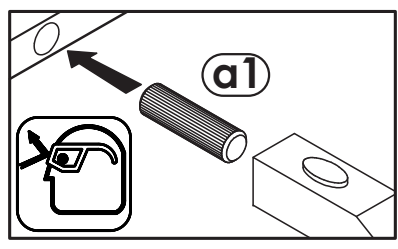
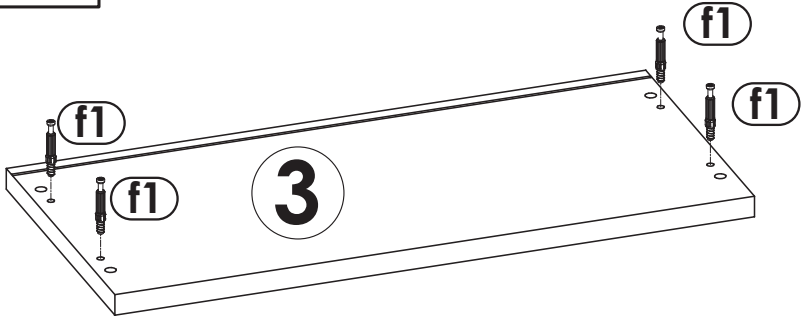
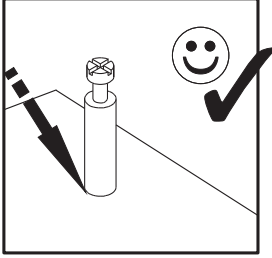
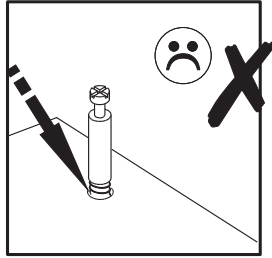
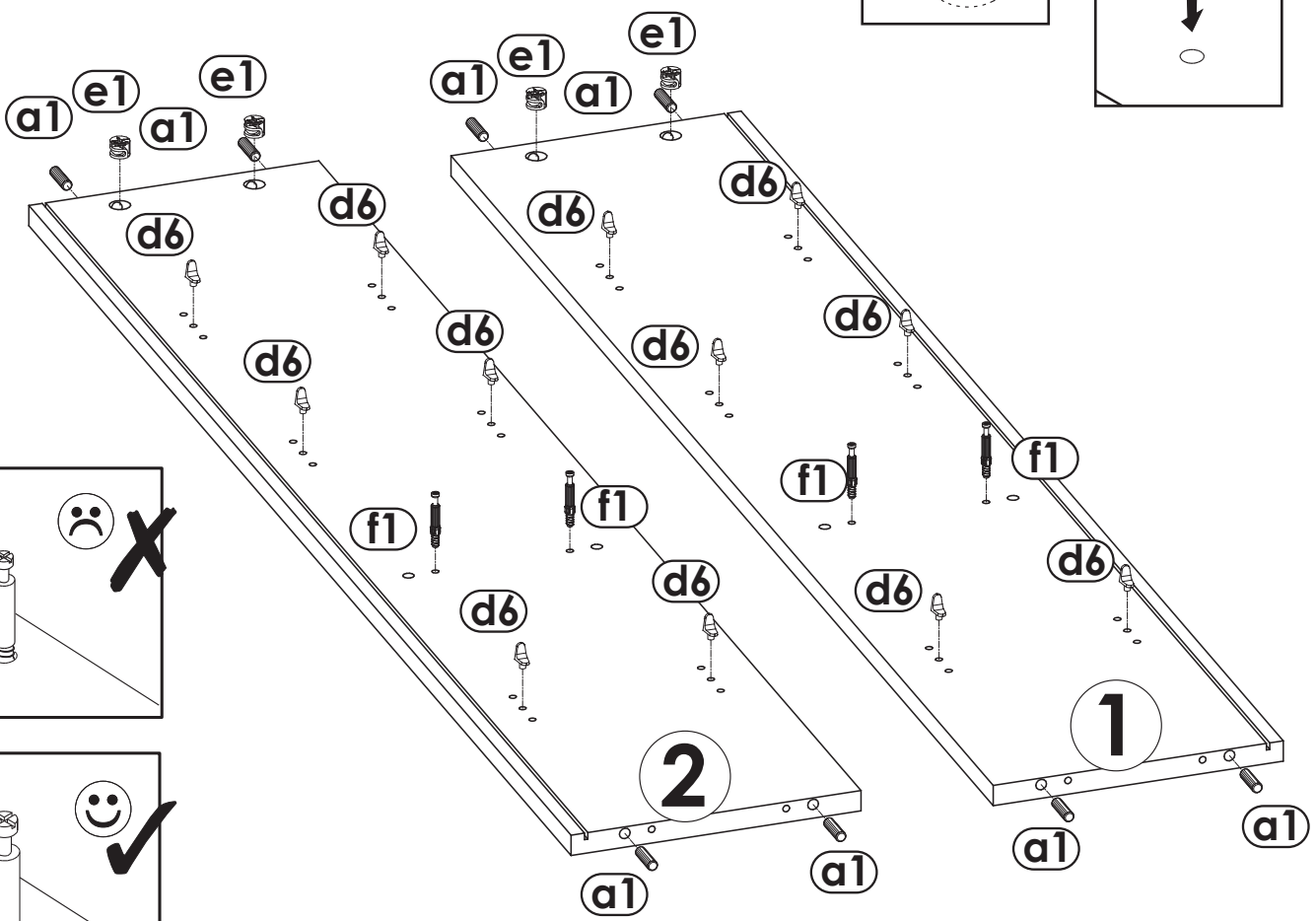
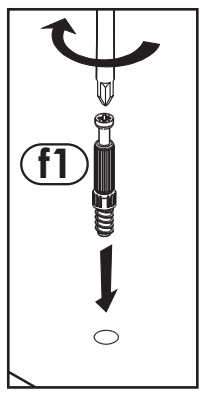
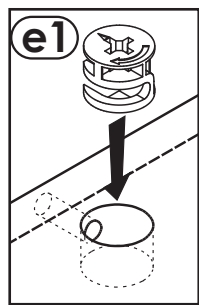
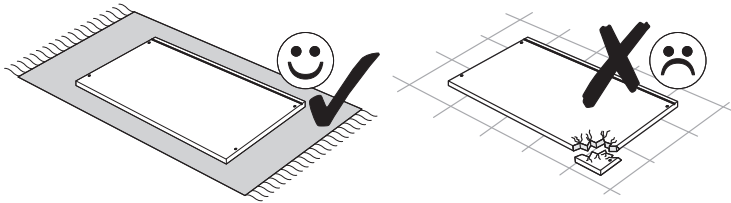

2

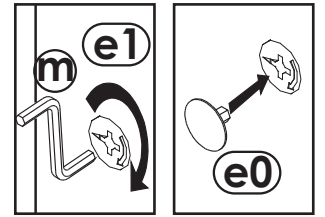
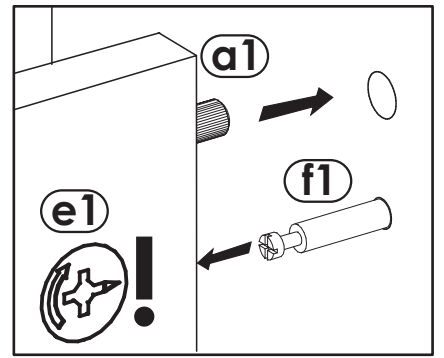
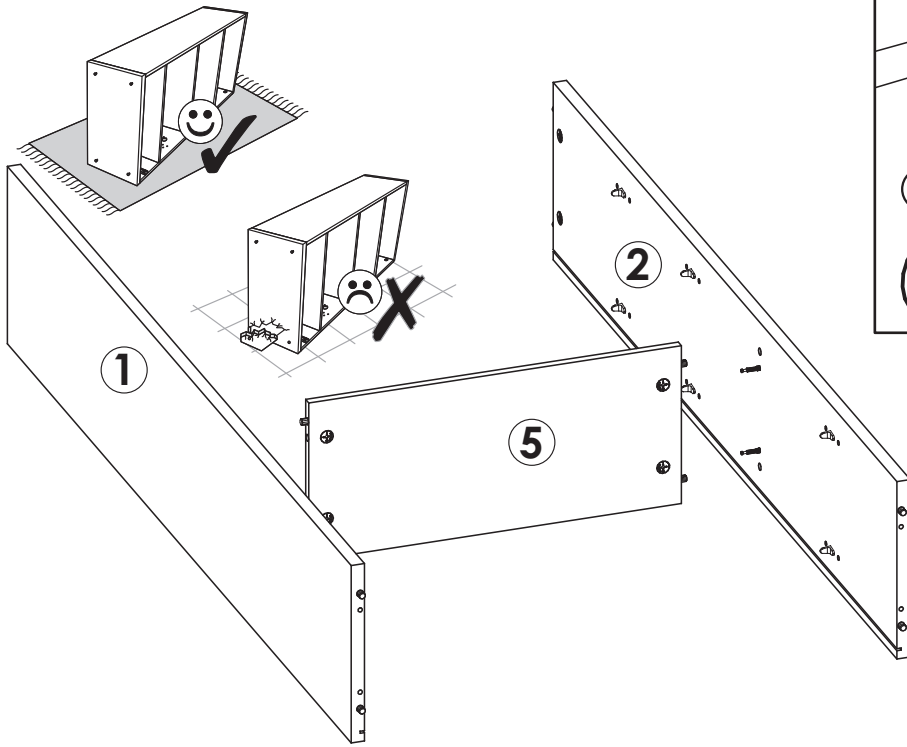

3

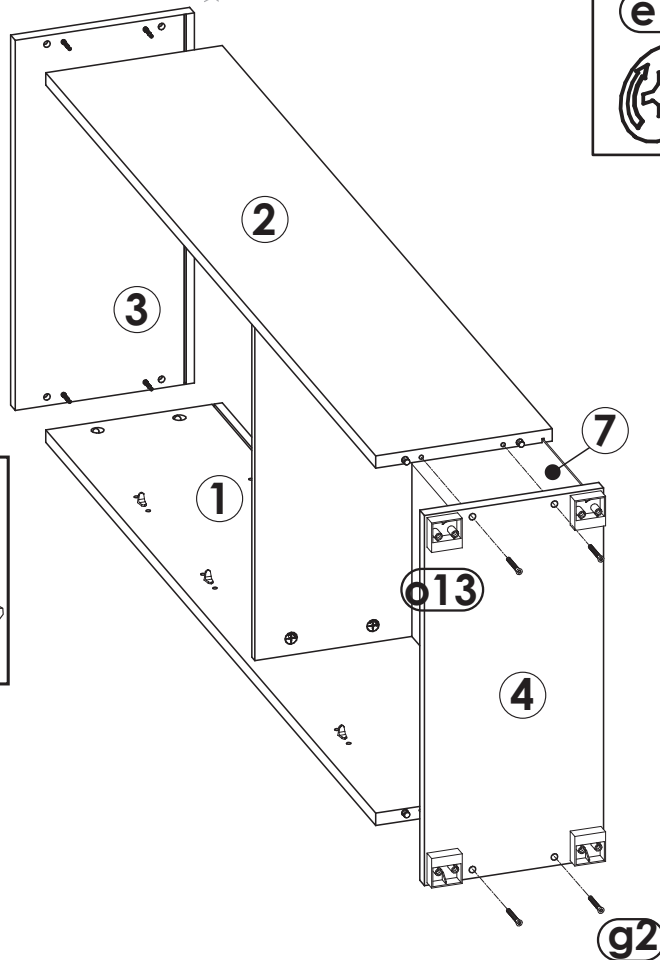
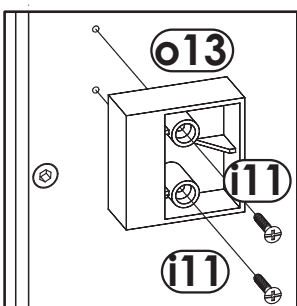
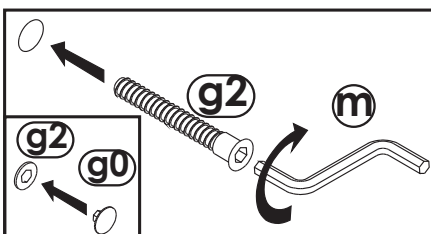
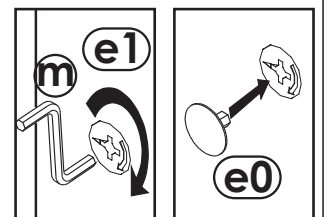
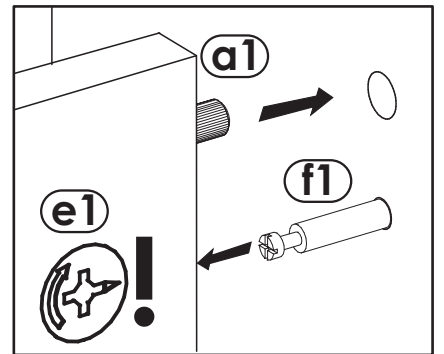
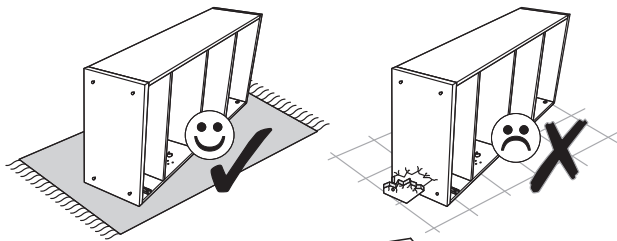

4
▼

A=B

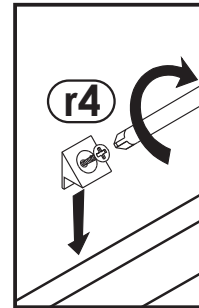
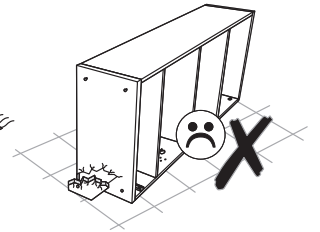
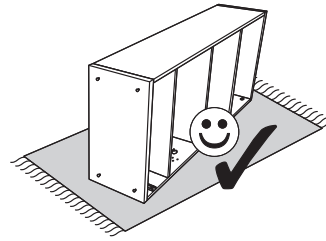
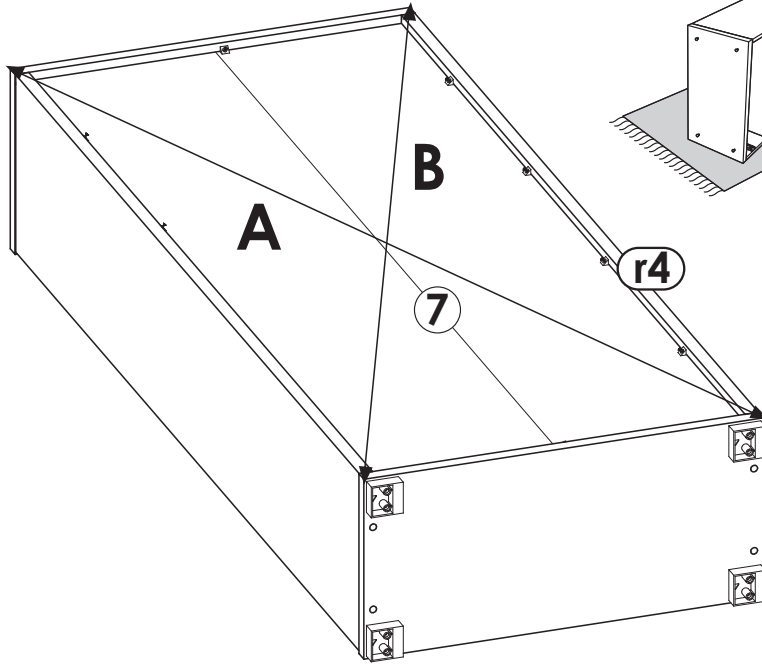

5
▼

