

# KONTOR K1 1

Art.-Nr.

15 550 181-01

|   |      |
|---|------|
| ↔ | 1000 |
| ↕ | 876  |
| ↗ | 470  |
|   | mm   |

1/8  
v0  
34-2023

|  |        |  |  |            |        |    |        |     |
|--|--------|--|--|------------|--------|----|--------|-----|
|  |        |  |  |            |        |    |        |     |
|  | 80 min |  |  | PZ 2, PZ 1 | 0,5 kg | 3m | 600 mm | Ø10 |

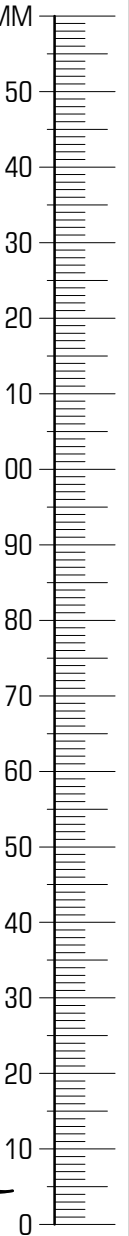
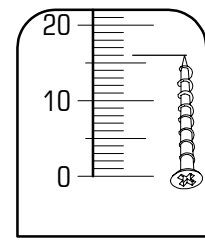
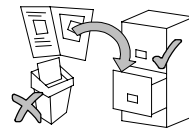
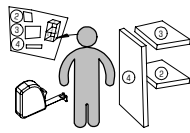
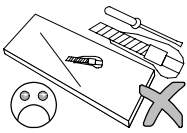
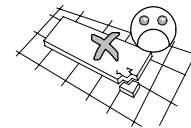
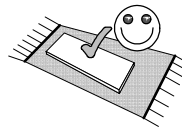
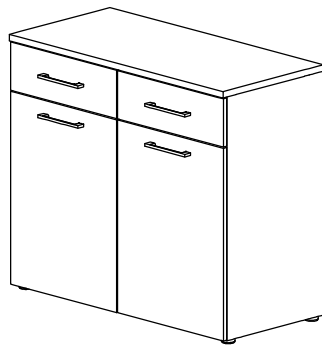
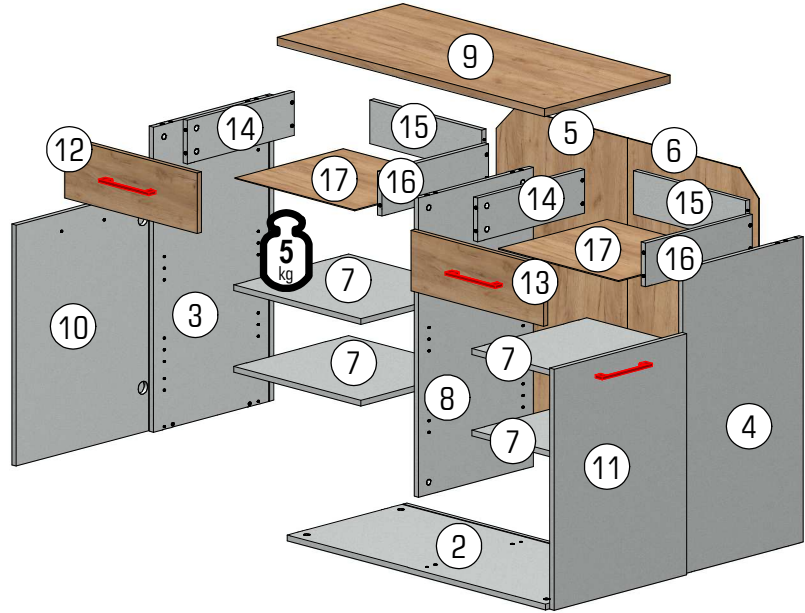

| ID    | ID | ID          | ID | ID  |
|-------|----|-------------|----|-----|
| 20342 | ②  | 966*448*16  | 1x | 1/2 |
| 20343 | ③  | 838*450*16  | 1x | 2/2 |
| 20344 | ④  | 838*450*16  | 1x | 2/2 |
| 20345 | ⑤  | 838*491*3   | 1x | 2/2 |
| 20357 | ⑥  | 838*491*3   | 1x | 2/2 |
| 20346 | ⑦  | 475*430*16  | 4x | 1/2 |
| 20347 | ⑧  | 822*430*16  | 1x | 2/2 |
| 20348 | ⑨  | 1000*470*22 | 1x | 1/2 |
| 20349 | ⑩  | 662*496*16  | 1x | 2/2 |
| 20350 | ⑪  | 662*496*16  | 1x | 2/2 |
| 20351 | ⑫  | 496*166*16  | 1x | 2/2 |
| 20501 | ⑬  | 496*166*16  | 1x | 2/2 |
| 20352 | ⑭  | 400*120*16  | 2x | 1/2 |
| 20353 | ⑮  | 419*120*16  | 2x | 1/2 |
| 20354 | ⑯  | 400*120*16  | 2x | 1/2 |
| 20355 | ⑰  | 449*406*3   | 2x | 2/2 |



|          |     |        |          |     |         |          |     |         |          |     |         |          |     |         |          |     |          |          |       |           |          |       |          |          |     |
|----------|-----|--------|----------|-----|---------|----------|-----|---------|----------|-----|---------|----------|-----|---------|----------|-----|----------|----------|-------|-----------|----------|-------|----------|----------|-----|
| 8402,03  |     | Ø8     | 22255,00 |     | Ø5,0x50 | 22236,00 |     | Ø2,5x16 | 22243,00 |     | Ø3,5x15 | 22244,01 |     | Ø3,5x16 | 34903,00 |     | 22250,00 |          | Ø4x25 | 222403,00 |          | M4x22 | 24008,00 |          | 3,0 |
| A        | 4x  |        | B        | 2x  |         | C        | 8x  |         | D        | 24x |         | E        | 12x |         | F        | 20x |          | G        | 5x    |           | H        | 8x    |          | J        | 8x  |
| 24101,00 |     | Ø10    | 27000,00 |     | Ø8x30   | 8501,00  |     |         | 30080,00 |     | Ø44x15  | 31103,00 |     |         | 32028,00 |     |          | 22705,00 |       | Ø6,8x8    | 22300,00 |       | Ø7x50    | 50553,00 |     |
| K        | 2x  |        | L        | 12x |         | M        | 16x |         | N        | 5x  |         | P        | 2x  |         | Q        | 4x  |          | R        | 8x    |           | S        | 8x    |          | T        | 10x |
| 70013,01 |     | Ø15x13 | 70021,01 |     |         | 36002,07 |     |         | 36002,07 |     |         | 33008,00 |     | L=400   | 33008,00 |     | L=400    |          |       |           |          |       |          |          |     |
| U        | 20x |        | V        | 20x |         | X        | 4x  |         | Y        | 4x  |         | Z1       | 2x  |         | Z2       | 2x  |          |          |       |           |          |       |          |          |     |



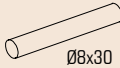

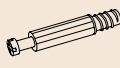

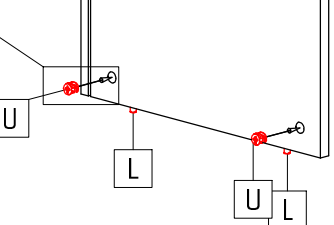
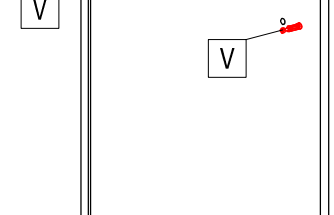
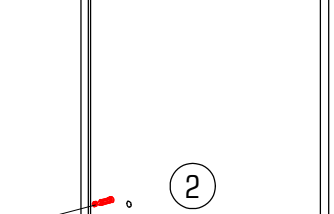
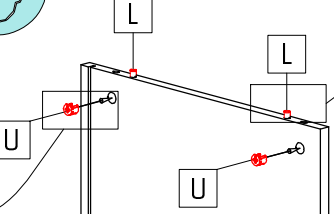
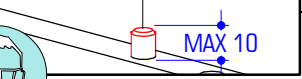
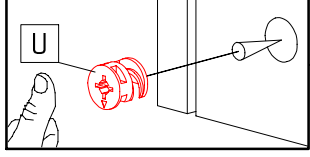
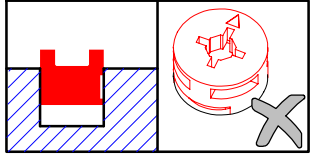
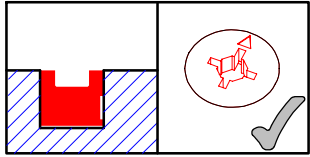
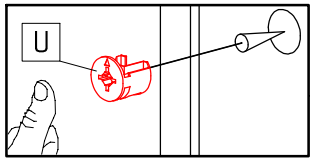
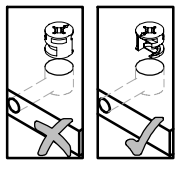
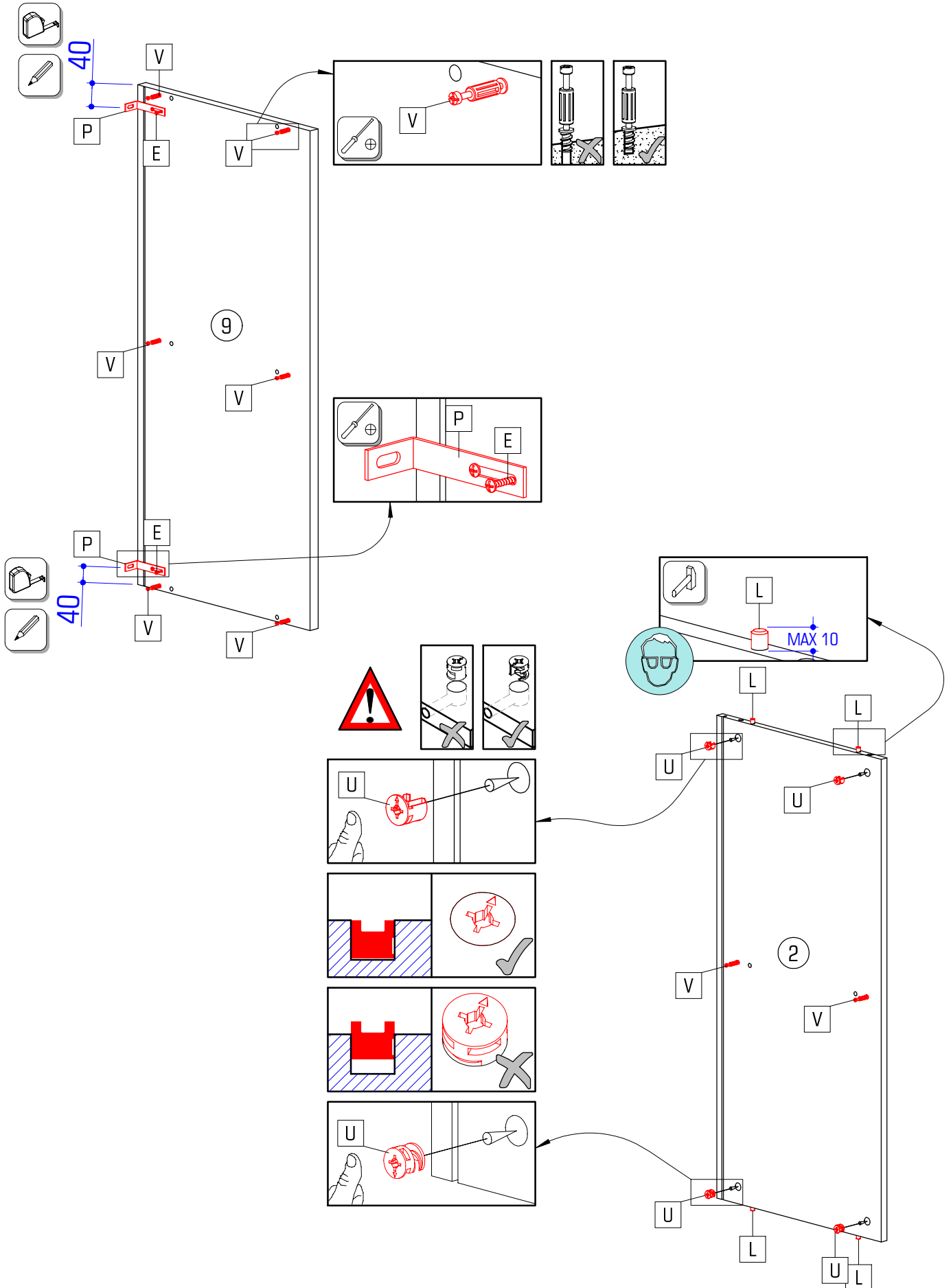
|  |  |  |  |  |  |  |  |  |  |
|--|--|--|--|--|--|--|--|--|--|
|  |  |  |  |  |  |  |  |  |  |
|--|--|--|--|--|--|--|--|--|--|

# 2/8 KONTOR K11

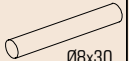
|  |   |   |   |   |
|--|---|---|---|---|
|  |  |  |  |  |
| E 4x   | L 4x  | P 2x  | U 4x  | V 8x  |

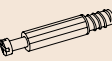

# KONTOR K11 3/8

|  |   |   |   |   |   |  |   |
|--|---|---|---|---|---|--|---|
|  |  |  |  |  |  |  |  |
| D  | L   | M   | R   | U   | V   | Y  | Z1  |
| 4x   | 8x  | 16x   | 8x  | 8x  | 4x  | 4x   | 2x  |
| $\varnothing 3,5 \times 15$  | $\varnothing 8 \times 30$   |   | $\varnothing 6,8 \times 8$  | $\varnothing 15 \times 13$  |   |  | L=400   |

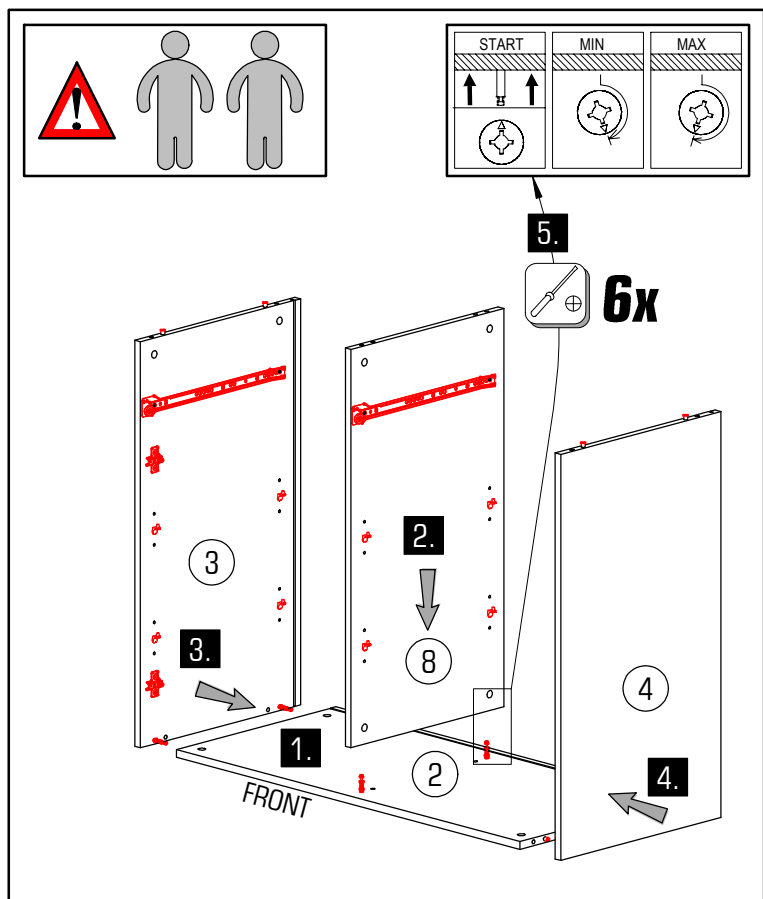
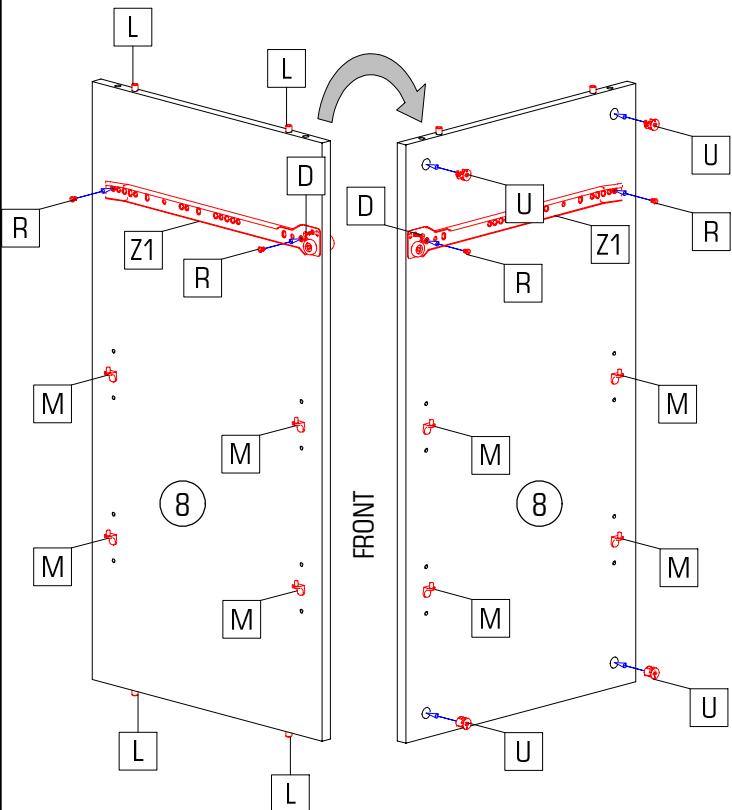
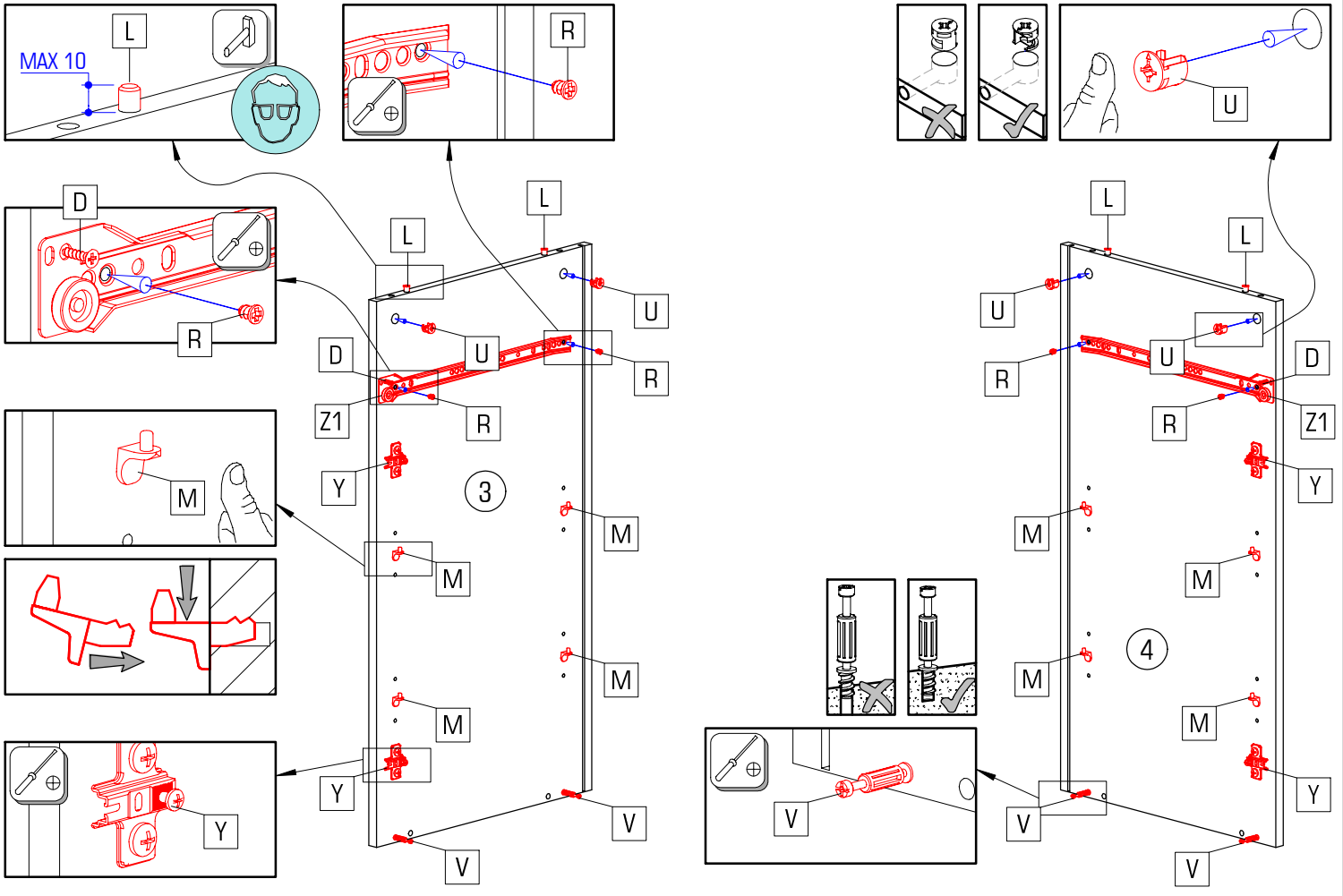

# 4/8 KONTOR K11

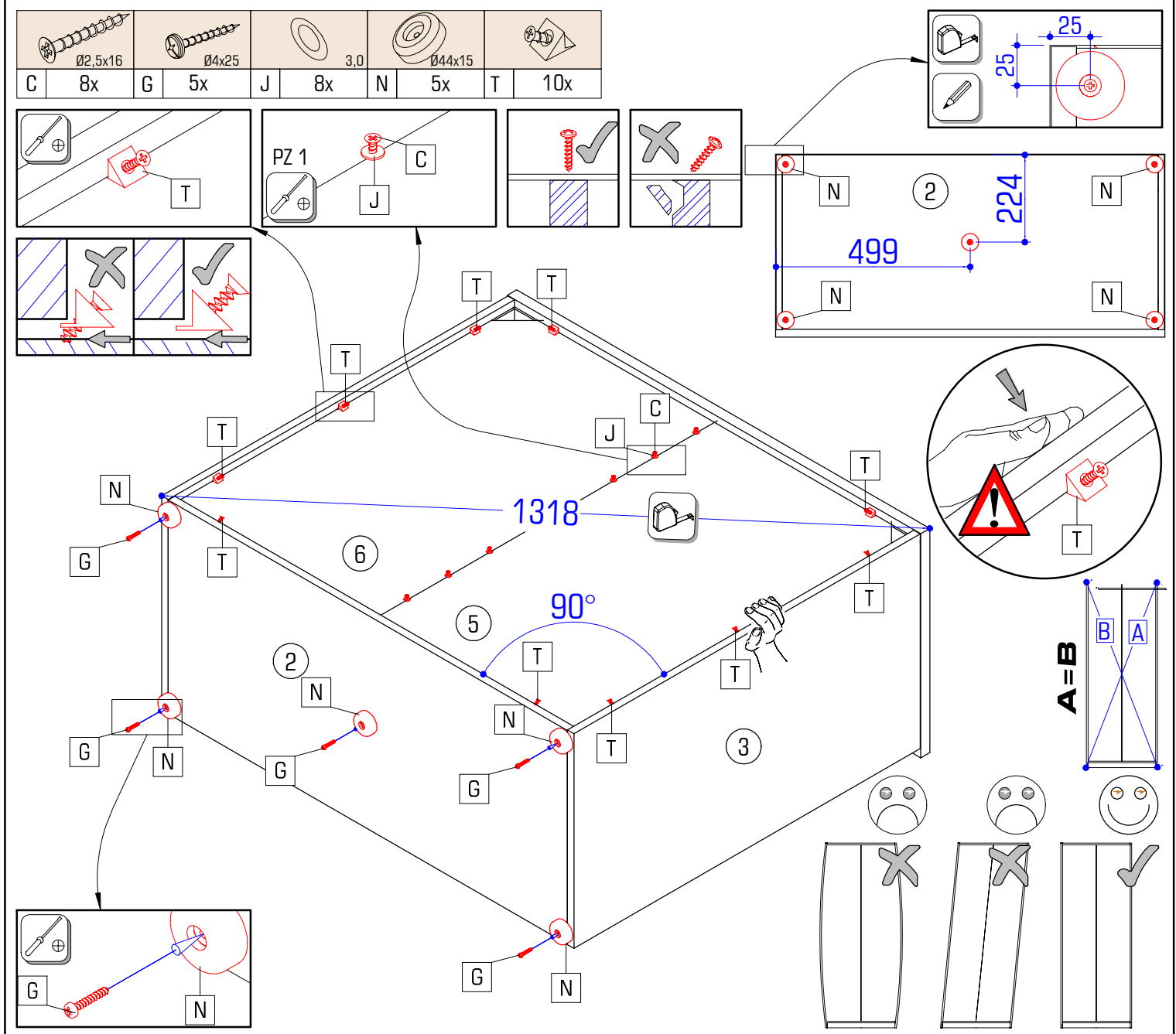
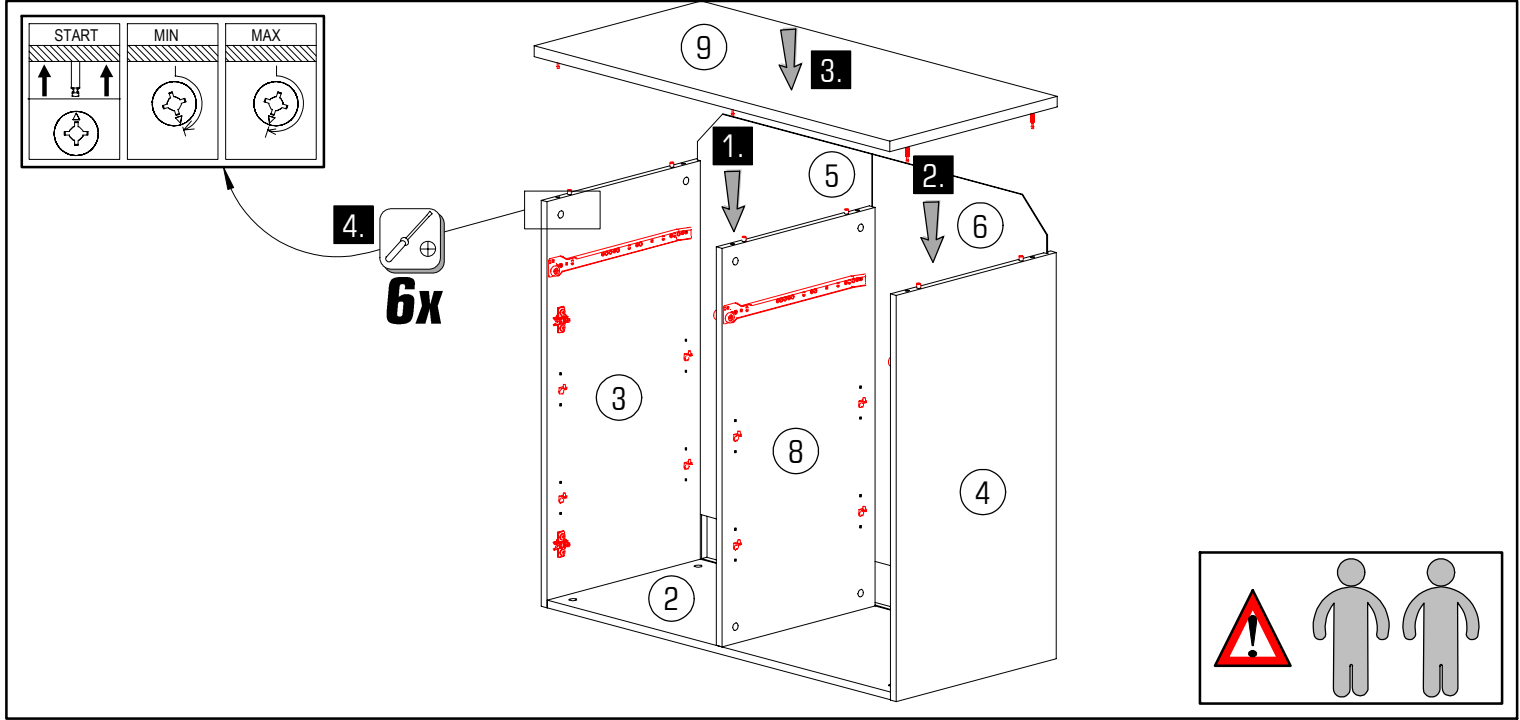

|         |      |
|---------|------|
|         |      |
| Ø5,0x50 | Ø10  |
| B 2x    | K 2x |

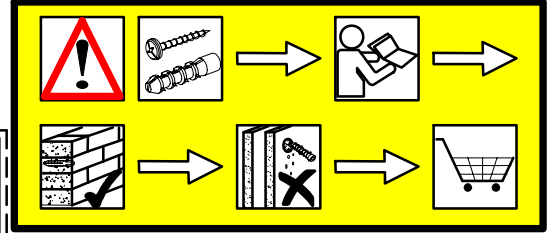

Caution! The wall must be examined before assembly. The included universal wall plugs are only suitable for using in firm masonry such as concrete block or brick. Do not use the wall plugs masonry such as hollow brick, lightweight block, surfaces such as gypsum plasterboard or other framing systems. If applicable, particular wall plugs must be used! These are available at a specialised store (hardware store). In case of non-compliance, the manufacturer/retailer or importer do not assume liability.

Upozornenie! Pevnosť steny sa musí pred montážou bezpodmienečne skontrolovať. Priložené univerzálne hmoždenky používajte jedine pre pevné murivo ako je betón/tehla. Hmoždenky sa nesmú používať v prípade ľahkého stavebného muriva, dutá tehla, Sádrokartónová doska, alebo iných konštrukcií rámu. U týchto stien je nutné použiť špeciálne hmoždenky! Tieto je možné dostať v špeciálnych predajniach so stavebným materiálom. Pri nedodržaní pokynov nepreberajú výrobcovia/predajci a dodávateľia zodpovednosť za vzniknuté škody.

Upozornění! Před montáží je nutné zkontrolovat stav stěny. Přiložené univerzální hmoždinky jsou určeny pouze k použití pro pevné zdivo jako beton/cihly. Hmoždinky do zdi se nesmí používat u dutinová cihla, zdiva jako pórovitý stavební kámen, sádrokartónová deska nebo jiný měkký materiál. U těchto zdív jsou nutné použít speciální hmoždinky! Jsou k dostání v speciálních prodejnách se stavebním materiálem. Při nedodržení těchto pokynů výrobce/prodejce a dovozce neručí za způsobené škody.

Pažnja! Prije montaže obvezno provjerite svojstvo zida. Priložene univerzalne tiplje namijenene su isključivo za masivne zidove od betona/opeke. Tiplje za masivne zidove ne smiju se koristiti za zidove kao npr šupljina opeka laki sastavni elementi, gips-kartonske ploče ili drugi modularni načini gradnje. Za te zidove potrebne su eventualno specijalne tiplje! Iste su dostupne u specijaliziranim trgovinama građevinskim materijalom. U slučaju nepridržavanja prethodno navedenih napomena, proizvođač/trgovac i uvoznik ne preuzimaju odgovornost!

Achtung! Die Wandbeschaffenheit ist vor der Montage unbedingt zu prüfen. Die beigelegten Universaldübel sind ausschließlich nur zur Verwendung für festes Mauerwerk wie Beton/Ziegel. Die Mauerdübel dürfen nicht bei Mauerwerk wie Hohlraumziegel, Leichtbausteinen, Gipskartonplatte oder anderer Rahmenbauweise verwendet werden. Bei diesen Mauerwerken sind gegebenenfalls Spezialdübel zu verwenden! Diese sind in einem Fachgeschäft erhältlich. Bei Nichteinhaltung wird seitens Produzenten/Händler und Importeure keine Haftung übernommen.

Vigyázat! Szerelés előtt a falfelületet feltétlenül vizsgálja meg. A mellékelt univerzális tiplik kizárólag stabil falazathoz használható mint például beton/tegla. A fal tiplje nem használható könnyű építőkövekhez, üreg tégla, gipszkarton lapokhoz vagy más fázvas építőanyagokhoz. Ezekhez a falfelületekhez csak speciális tiplik használhatóak, melyek szaküzletekben (barkácsáruházakban) beszerezhetőek. Fentiek figyelmen kívül hagyása esetén a gyártó/kereskedő vagy forgalmazó nem vállal felelősséget.

Obs! Väggens sammansättning ska absolut kontrolleras innan montering. De bifogade pluggarna får endast användas för stabila och fasta väggar, som t.ex. betong/tegel. De får absolut inte användas för kavitet tegel, väggar ur fonolit, gipsskivor eller dylikt. För dessa väggar måste det användas speciella pluggar, som finns att köpa i specialiserad handel (byggmarknad). Varken tillverkare, handlare eller importör övertar ansvar, om dessa anvisningar inte följs.

Pozor! Pred montažo preverite stanje stene. Priloženi univerzalni mozniki so izključno samo za uporabo na čvrstem zidovju, kot sta beton in opeka. Stenski mozniki se ne smejo uporabljati pri zidovju kot so votlina opeke, zidaki za lahko gradnjo, mavčne plošče ali druge okvirne gradnje. Pri teh zidovjih morate v danih primerih uporabljati posebne moznike. Ti so na voljo v specializiranih trgovinah (trgovinah z gradbenim materialom). Pri upoštevanju se s strani proizvajalca/trgovca in uvoznika ne prevzame jamstvo.

Uwaga! Ścianę należy sprawdzić przed montażem. Dołączone uniwersalne kołki rozporowe są odpowiednie tylko do stosowania w mocnych murach, takich jak beton lub cegła. Nie rób za pomocą kołków rozporowych murowanych, takich jak pustak, lekka kostka, powierzchnie takie jak płyty gipsowo-kartonowe lub inne systemy ram. Jeśli dotyczy, muszą to być określone kołki rozporowe być użytymi! Są one dostępne w specjalistycznym sklepie niezgodność, producent / sprzedawca lub importer nie ponoszą odpowiedzialności.

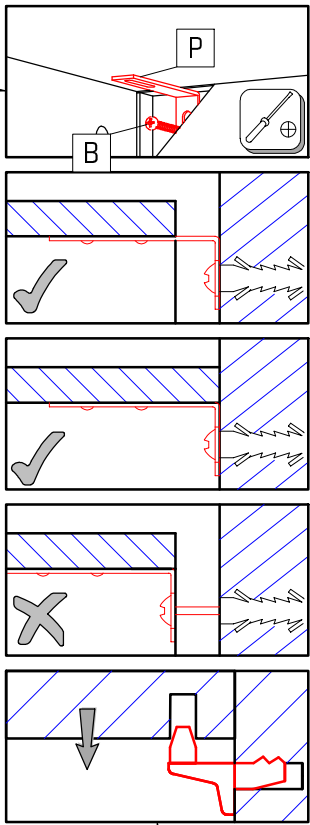
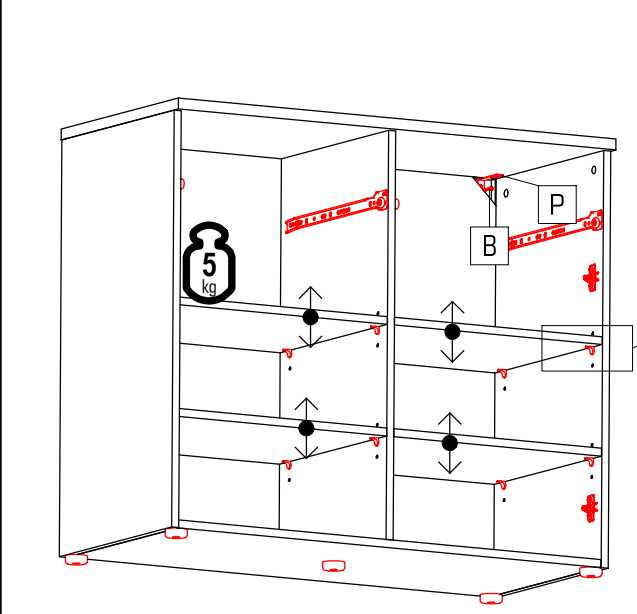
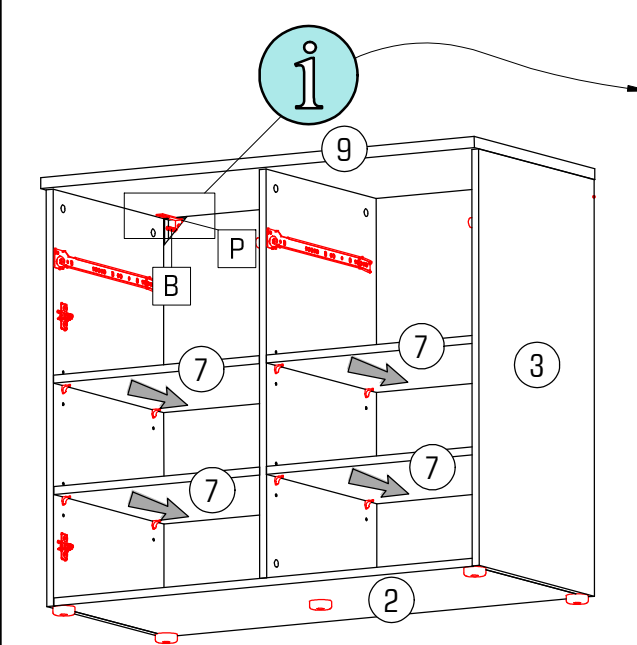
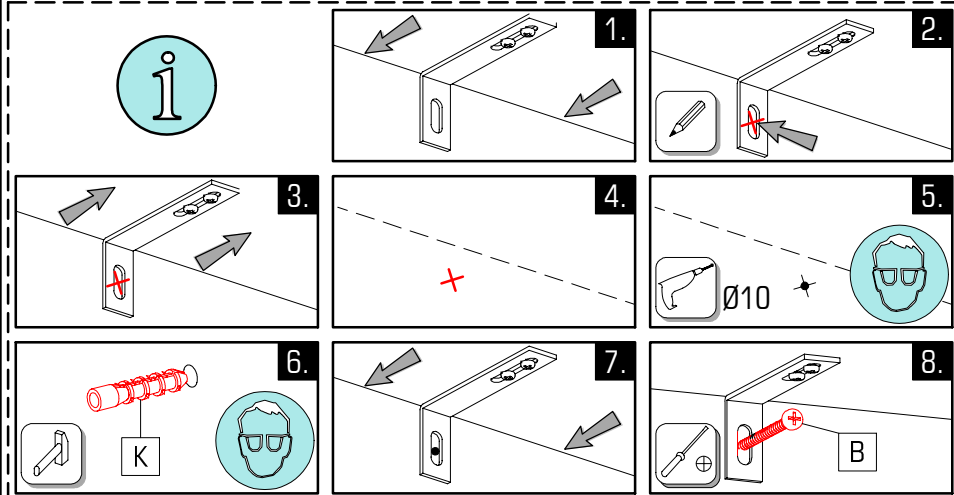

- EN WARNING
- SK VÝSTRAHA
- CZ VAROVÁNÍ
- HR UPOZORENJE
- DE WARNUNG
- HU FIGYELEM
- SE VARNING
- SI OPOZORILO
- PL OSTRZEŻENIE



± 32

# 6/8 KONTOR K11

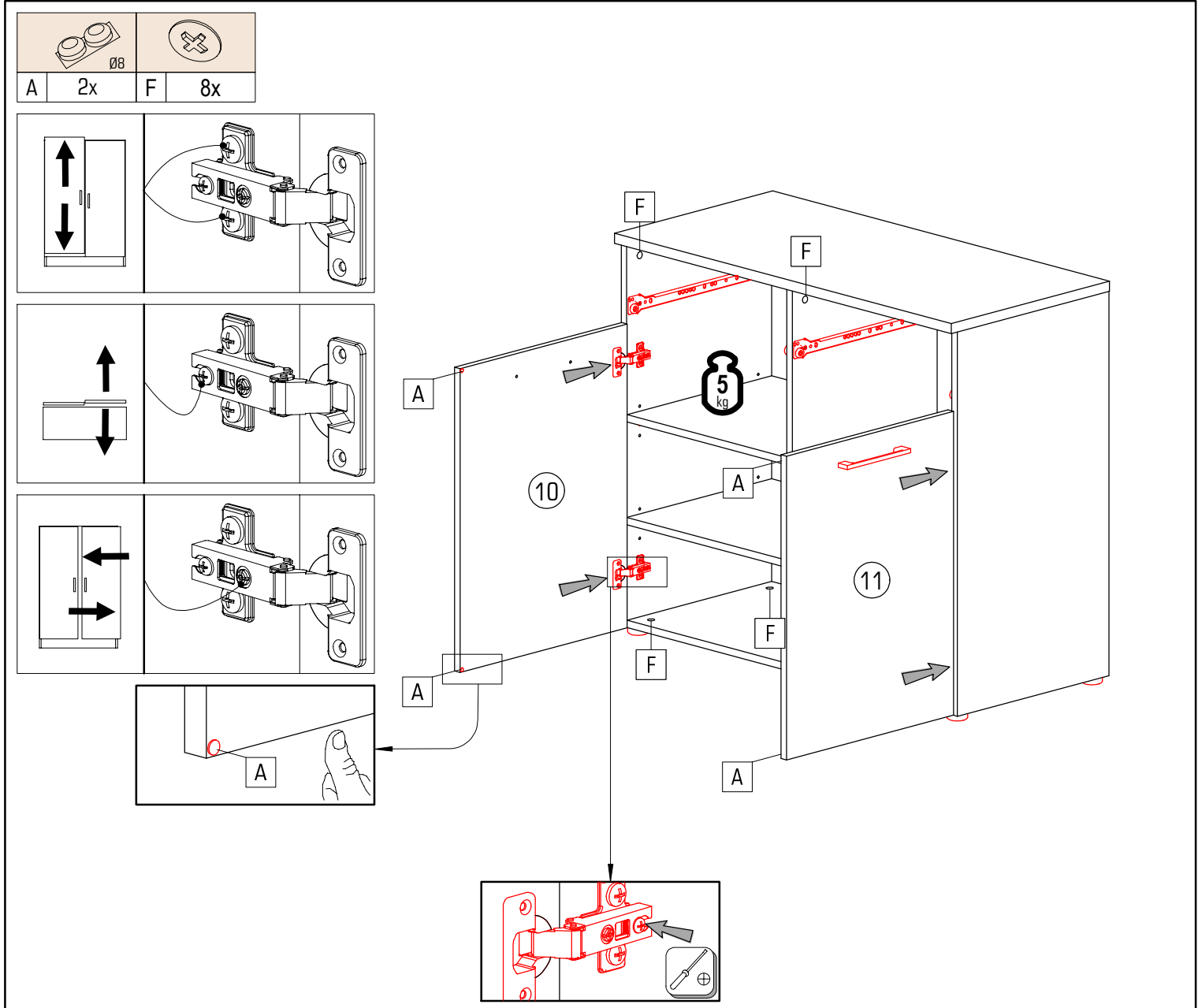
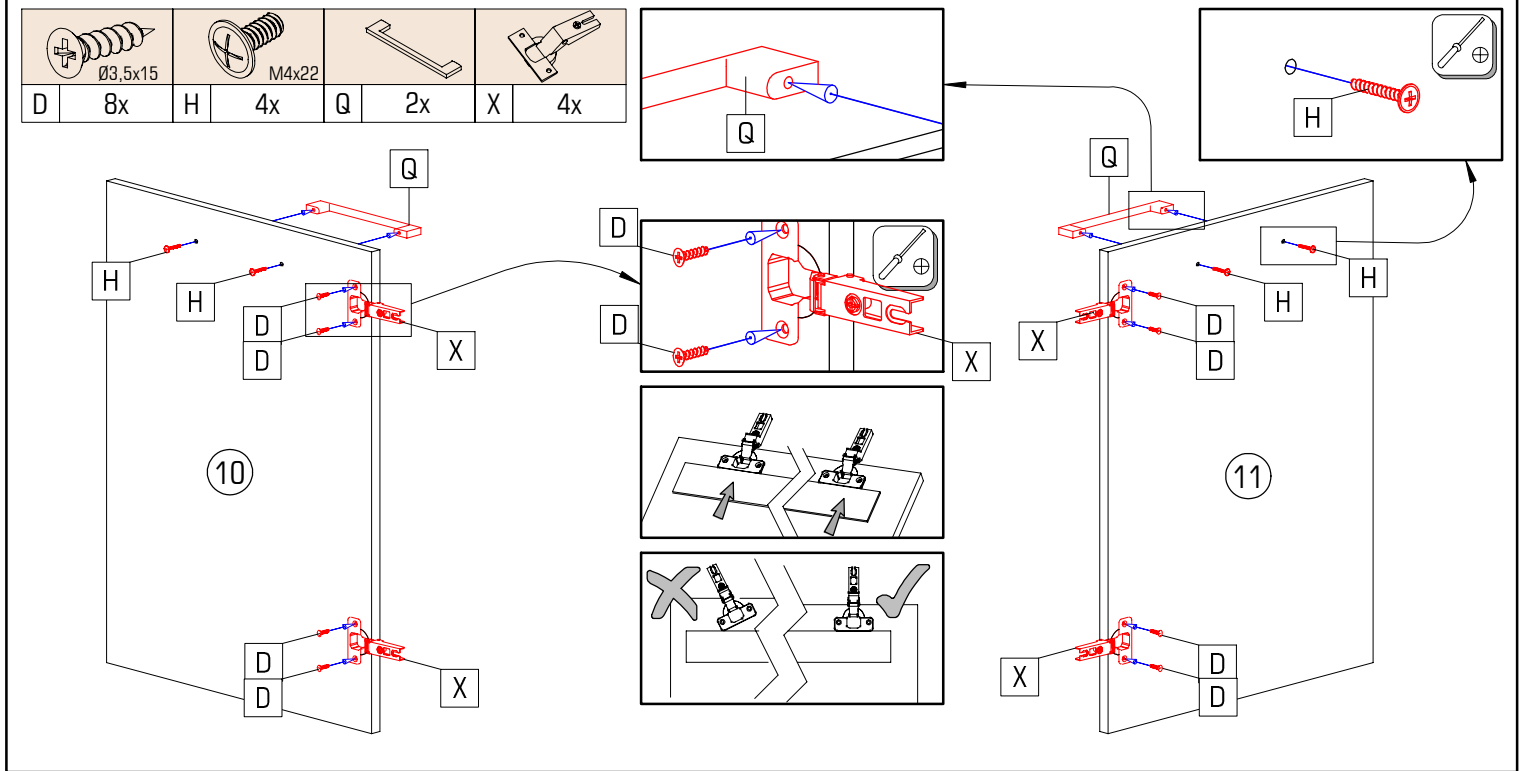



# KONTOR K11 7/8

|      |       |      |      |      |      |      |      |      |       |
|------|-------|------|------|------|------|------|------|------|-------|
|      |       |      |      |      |      |      |      |      |       |
| A 2x | D 12x | E 8x | H 4x | Q 2x | S 8x | U 8x | V 8x | F 8x | Z2 2x |

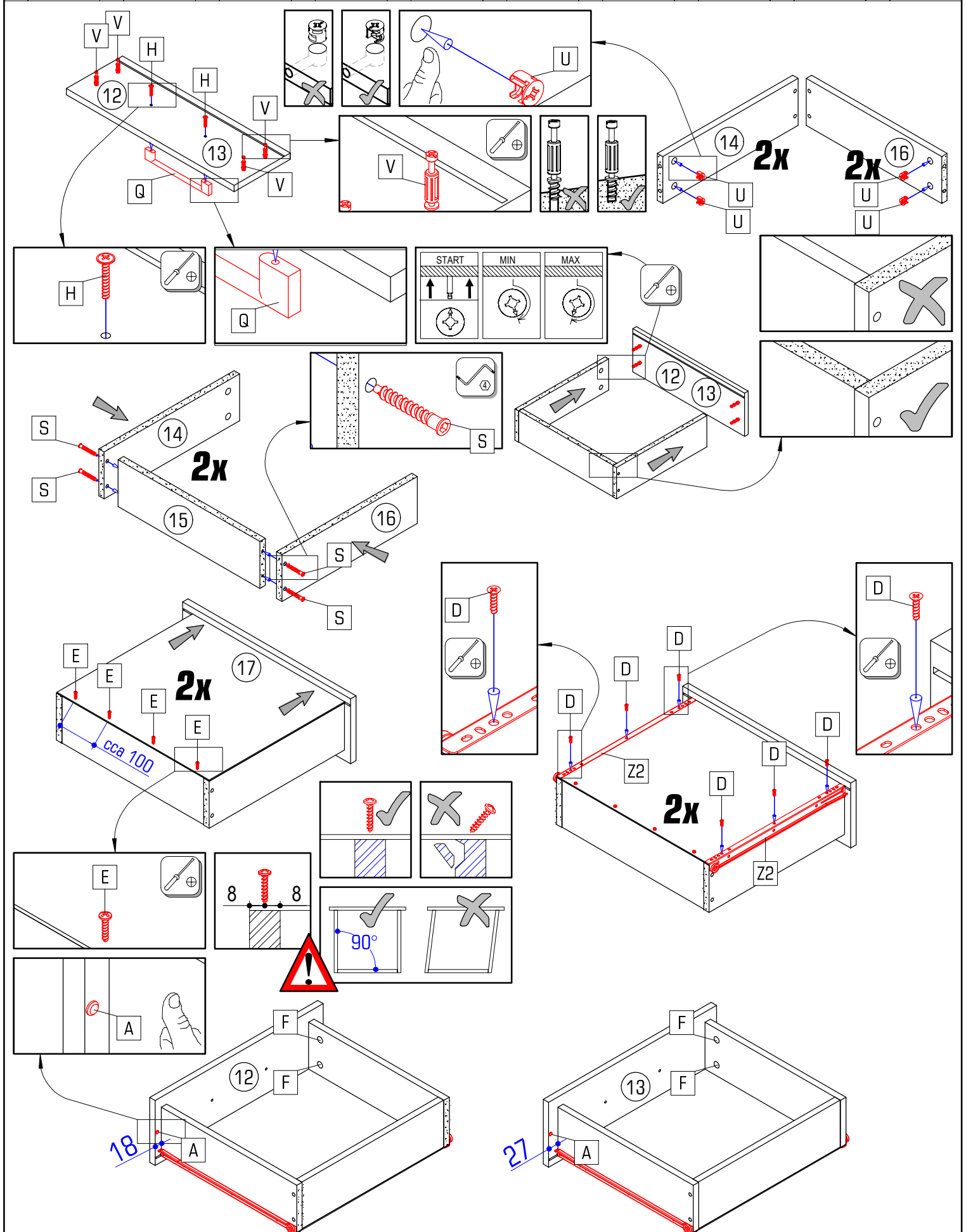

# 8/8 KONTOR K11

