

# LASSE 3T 1SP

Art.-Nr.

15 550 195 - 05

↔	1350
↕	1965
↗	550
	[mm]

1 / 16  
v0  
36-2025

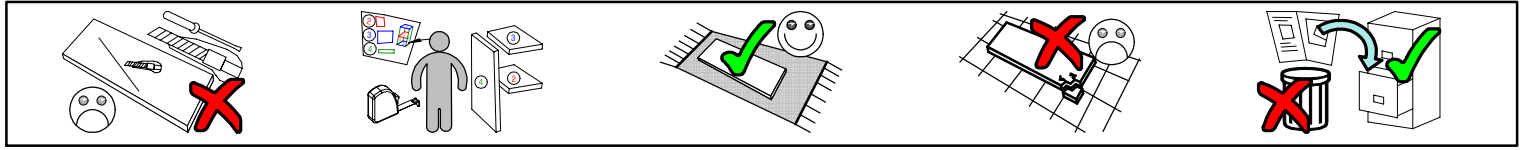
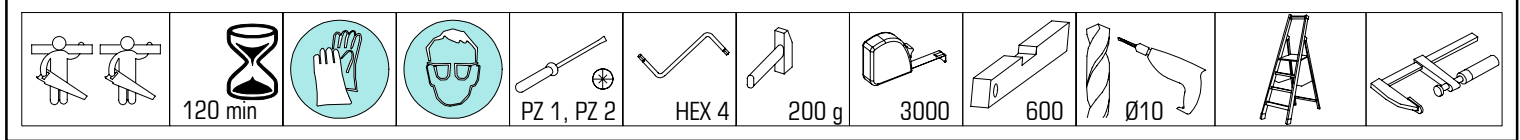



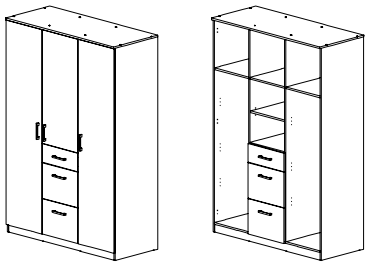
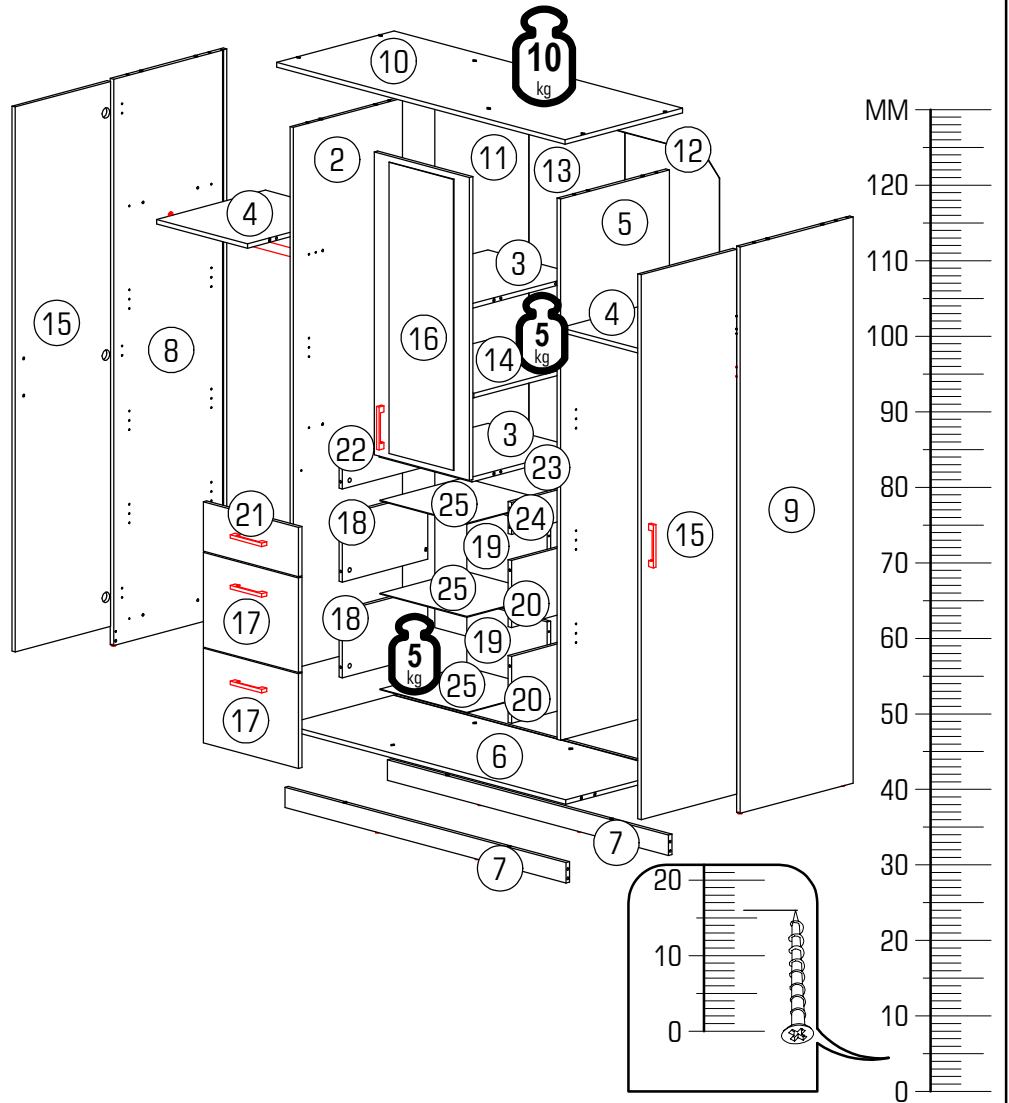

ID	ID	Icon	Icon	Icon
22314	②	1859*510*16	1x	2/4
22315	③	434*509*16	2x	2/4
22316	④	425*509*16	2x	2/4
22317	⑤	1859*510*16	1x	2/4
22318	⑥	1316*528*16	1x	1/4
22319	⑦	1316*70*16	2x	1/4
22320	⑧	1945*529*16	1x	3/4
22321	⑨	1945*529*16	1x	3/4
22322	⑩	1350*550*16	1x	1/4
22323	⑪	1875*441*3	1x	3/4
22324	⑫	1875*441*3	1x	3/4
22325	⑬	1875*450*3	1x	3/4
22326	⑭	434*500*16	1x	1/4
22327	⑮	1872*446*16	2x	4/4
22328	⑯	1040*446*16	1x	4/4
22329	⑰	446*325*16	2x	4/4
22330	⑱	400*230*16	2x	1/4
22331	⑲	376*230*16	2x	1/4
22332	⑳	400*230*16	2x	1/4
22333	㉑	446*170*16	1x	4/4
22334	㉒	400*110*16	1x	1/4
22335	㉓	376*110*16	1x	1/4
22336	㉔	400*110*16	1x	2/4
22337	㉕	406*406*3	3x	3/4

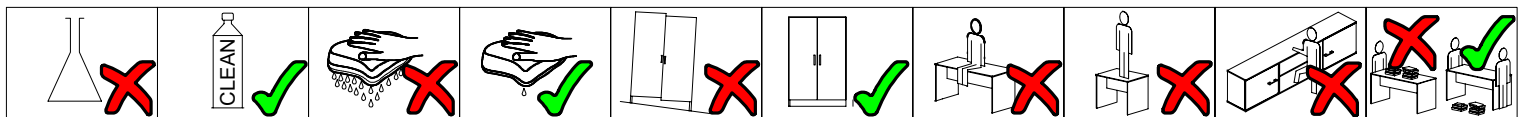

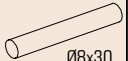
8402_03		Ø8	22255_00		Ø5,0x50	24101_00		Ø10	31103_00		22280_00		Ø4x30	32041_00		L=146	22243_00		Ø3,5x15	22244_01		Ø3,5x16	22300_00		Ø7x50
A	6x	B1	2x	B2	2x	B3	2x	C1	12x	C2	6x	D	52x	E	16x	F	24x								
22800_01		4	50553_00		34902_00		24008_00	3,0	27000_00		Ø8x30	22236_00		Ø2,5x16	22705_00		Ø6,8x8	30091_00		30091_00		35101_01		4x	
G	1x	H	14x	J	28x	K	32x	L	36x	M	32x	N	12x	P	8x	Q	4x								
36013_02		36013_02		70018_04		70013_01		Ø15x13	70021_01		70017_04		420	36002_07		36002_07		33008_00		400	33008_00		400		
R	2x	S	2x	T	4x	U	36x	V	36x	W	2x	X	6x	Y	6x	Z1	3x	Z2	3x						

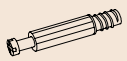

					
D 6x	L 4x	P 4x	T 2x	V 12x	Y 6x

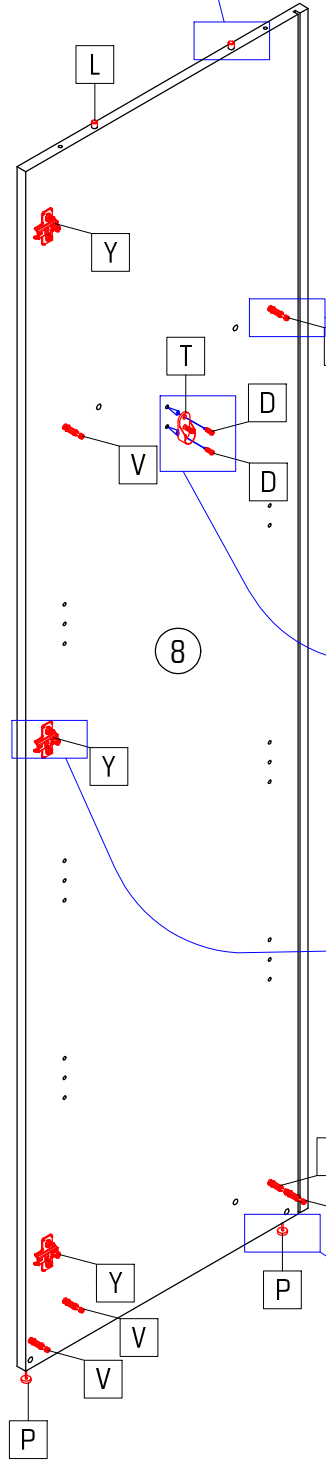
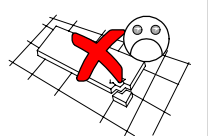
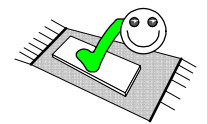
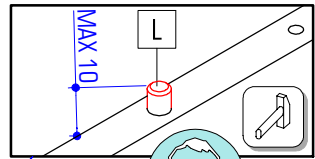
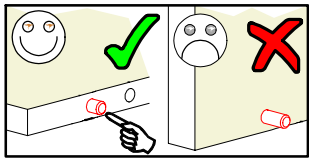

8

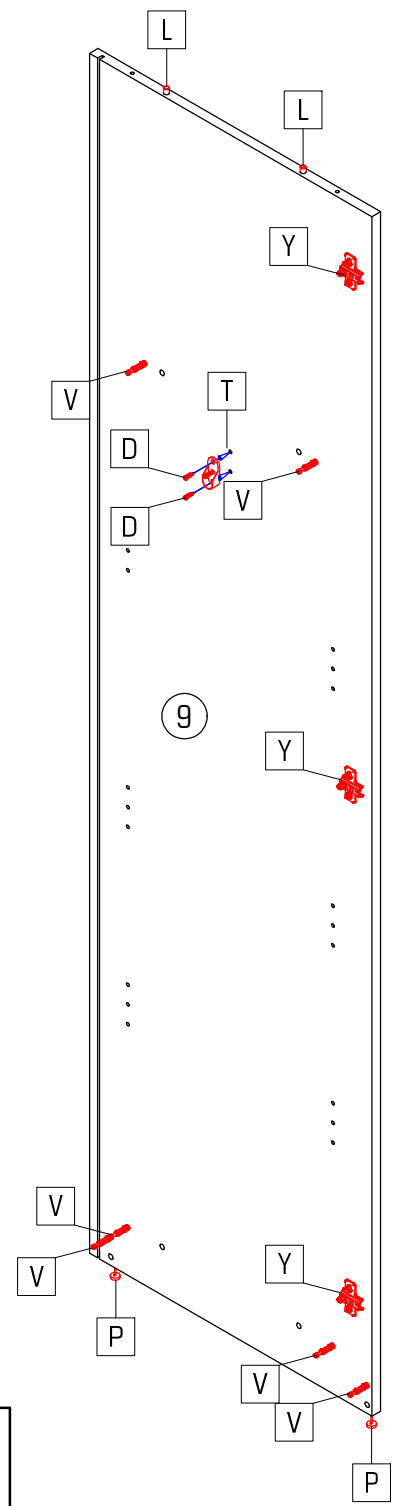
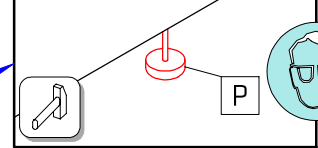
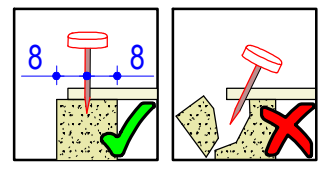
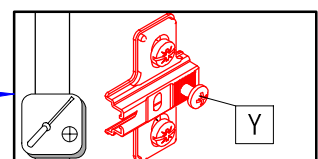
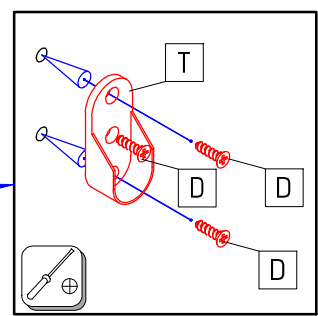
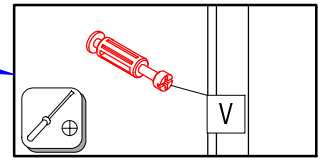
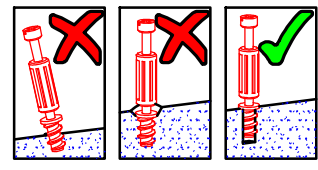

9



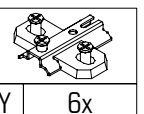

Y 6x



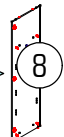
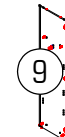



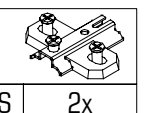



S 2x

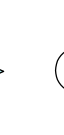



D 6x	L 2x	N 6x	Q 2x	V 6x	T 1x	Z1 3x

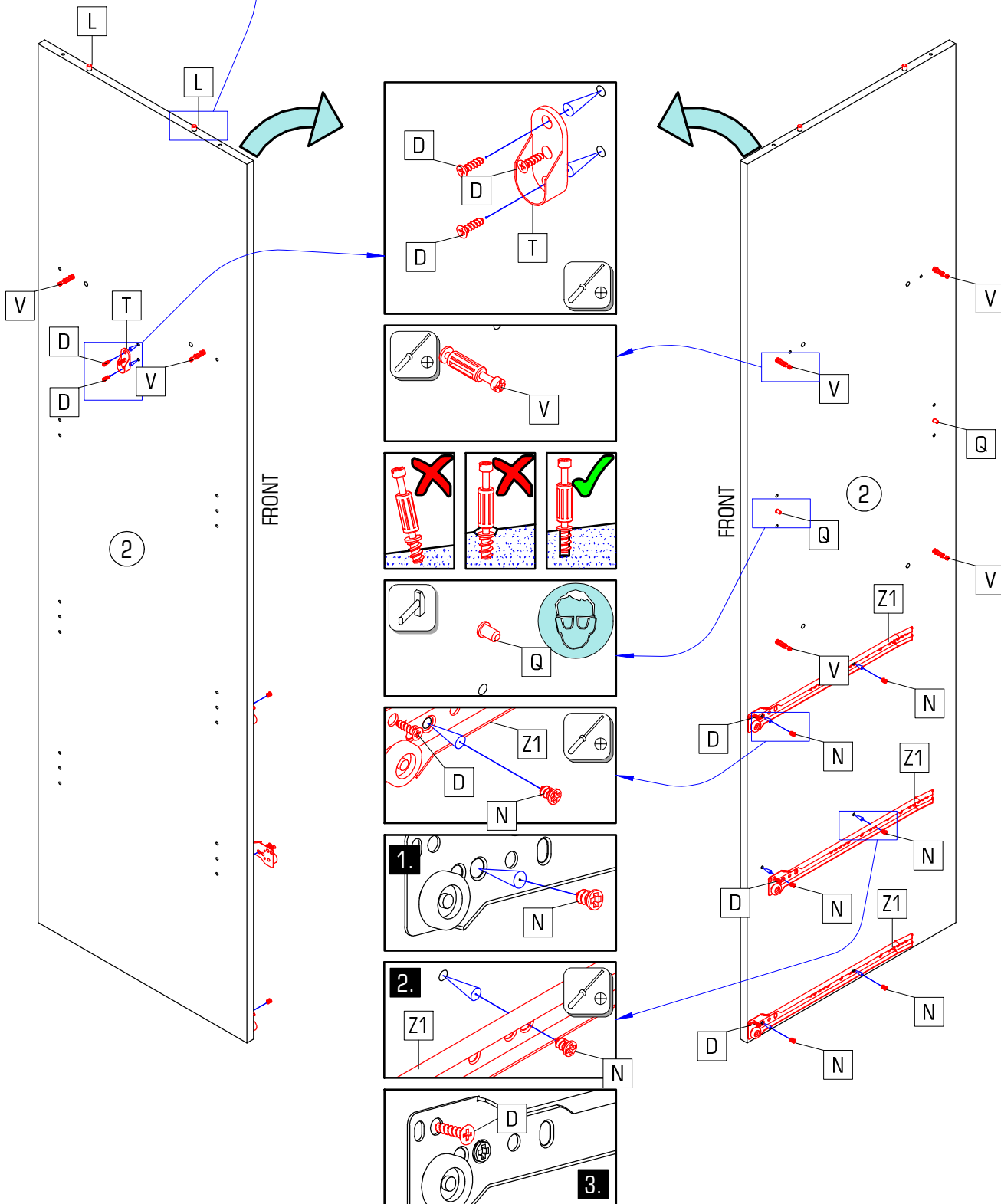
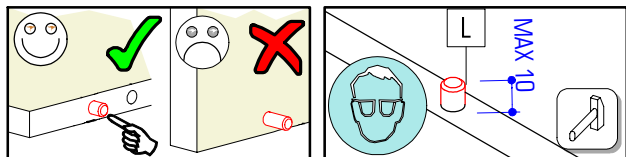
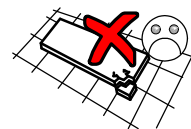
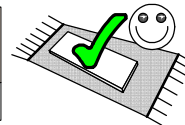

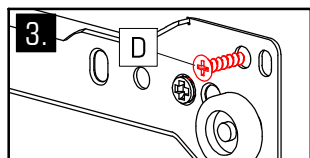
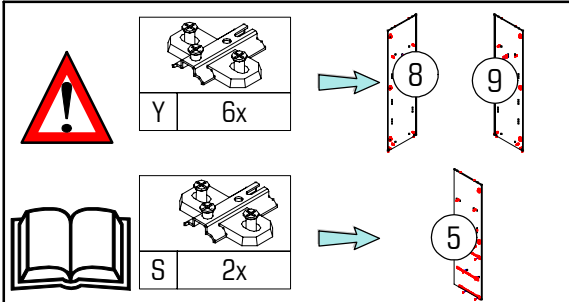
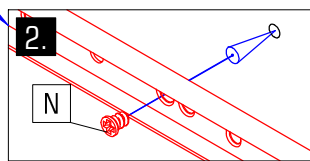
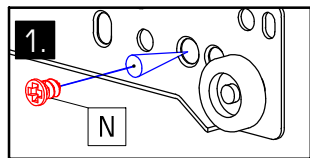
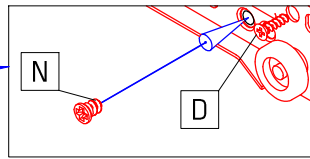
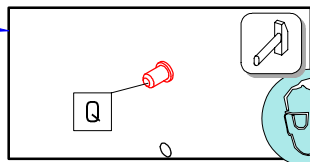
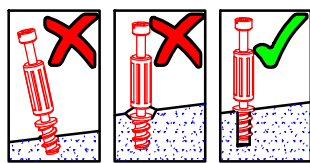
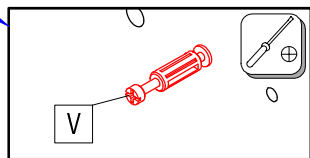
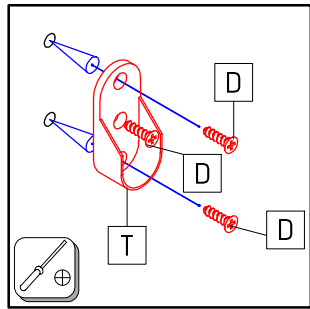
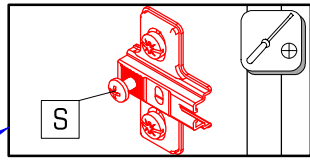
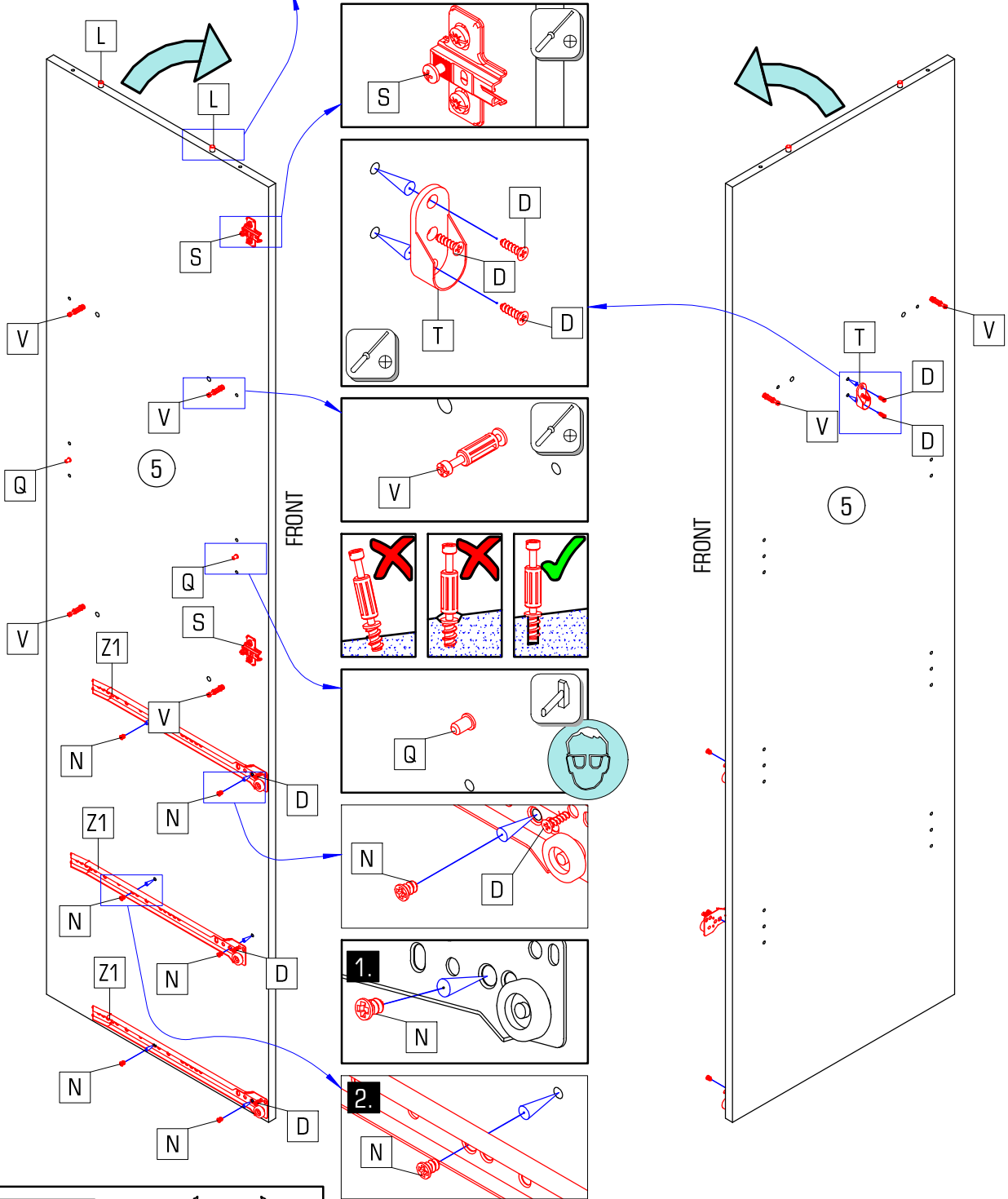
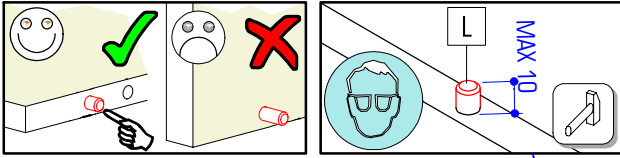
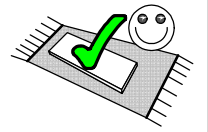
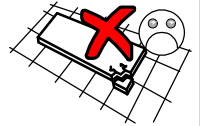

D 6x	L 2x	N 6x	Q 2x	S 2x	V 6x	T 1x	Z1 3x

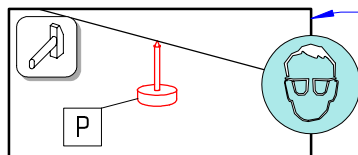
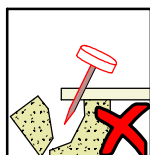
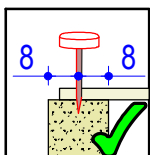
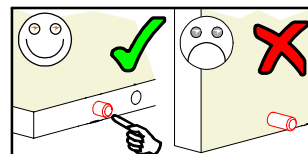
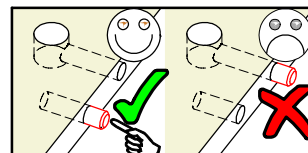
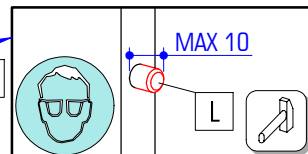
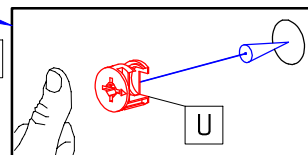
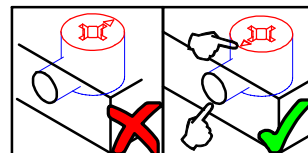
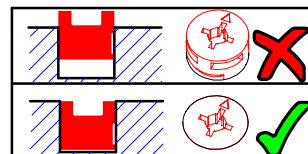
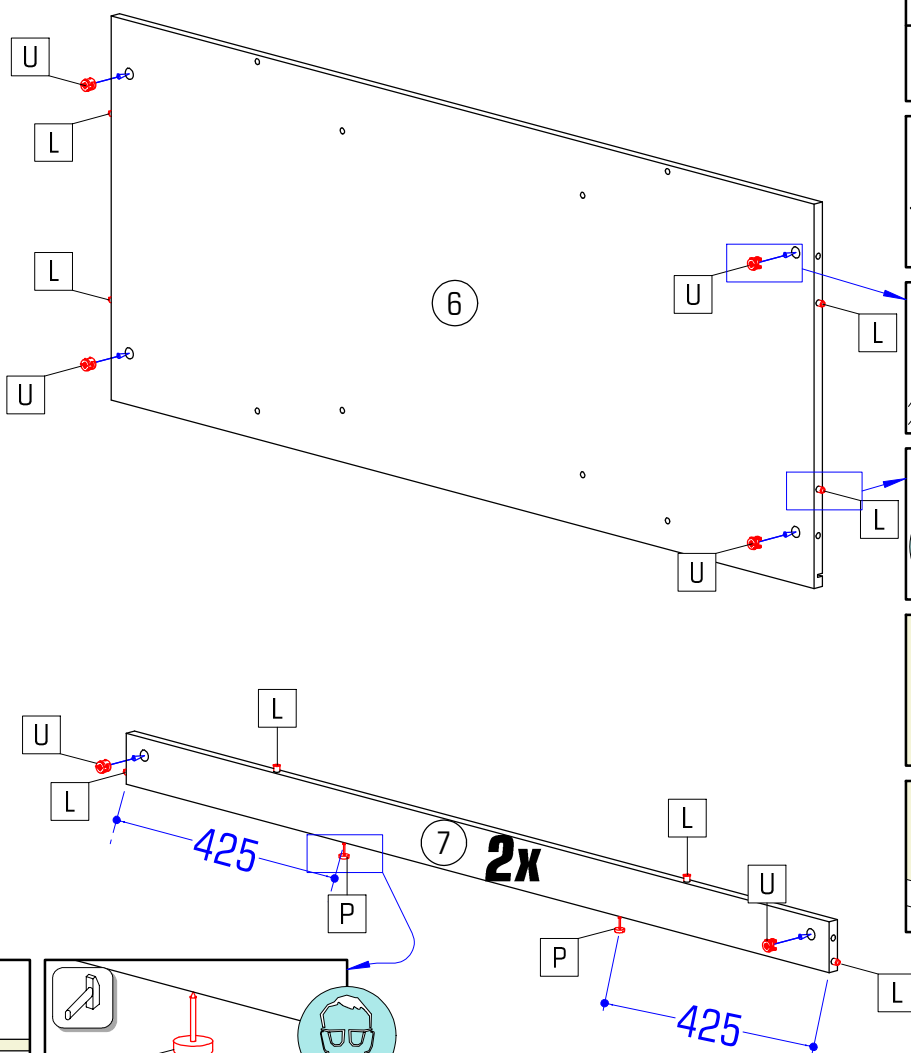
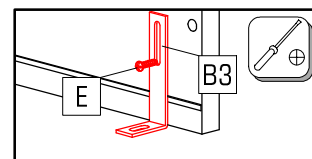
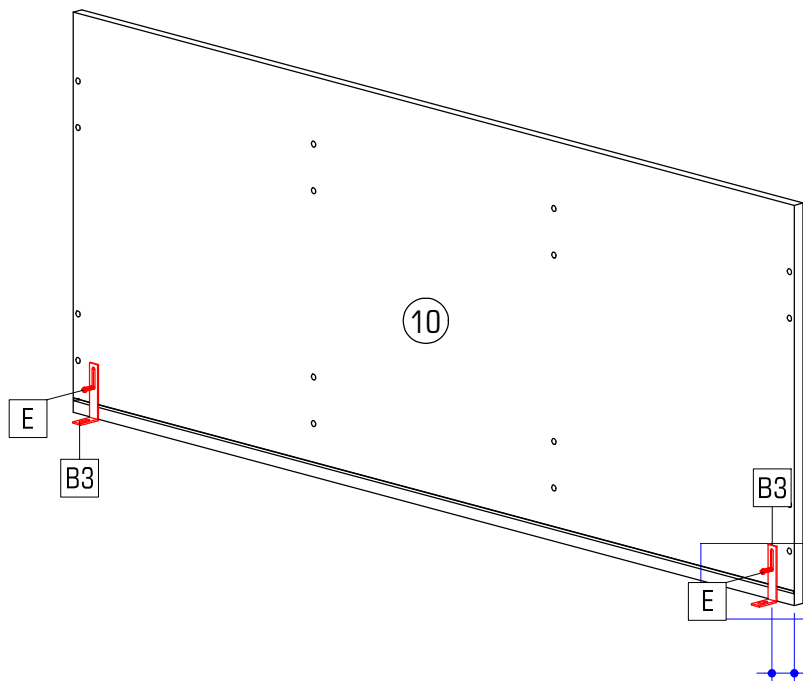
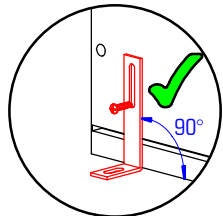
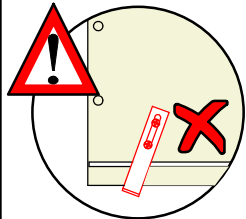
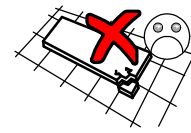
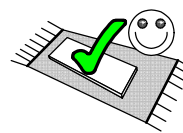

B3	Ø3,5x16	Ø8x30	Ø15x13	
2x	4x	12x	4x	8x

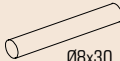

	Ø8x30		Ø15x13
L	16x	U	16x

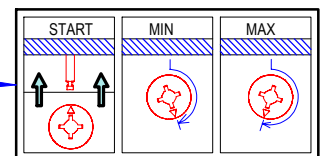
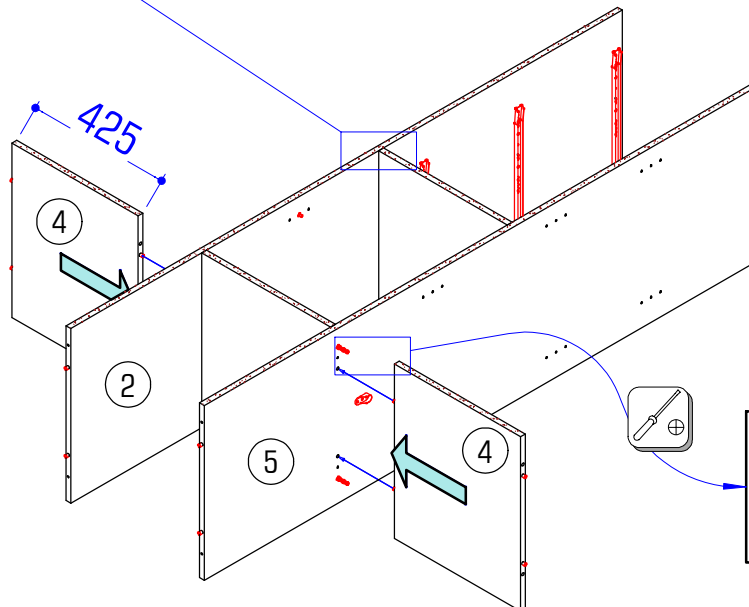
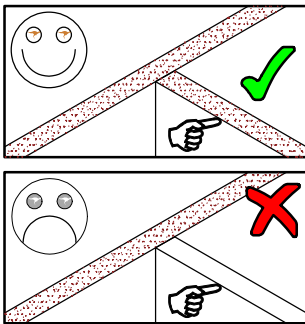
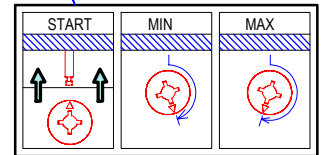
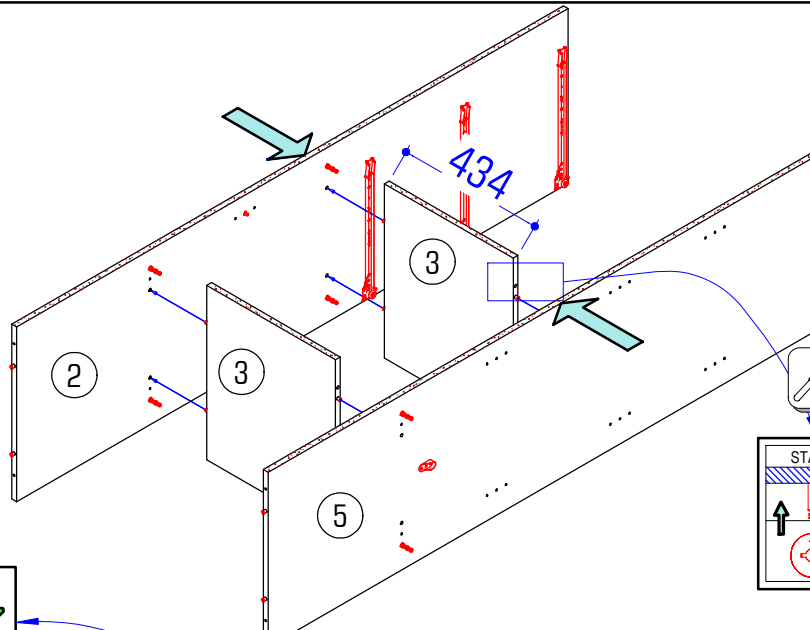
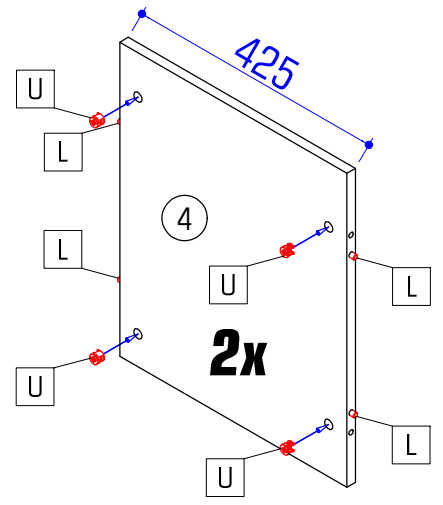
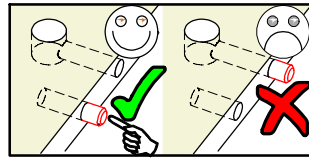
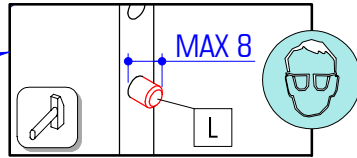
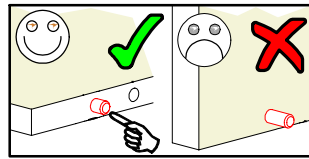
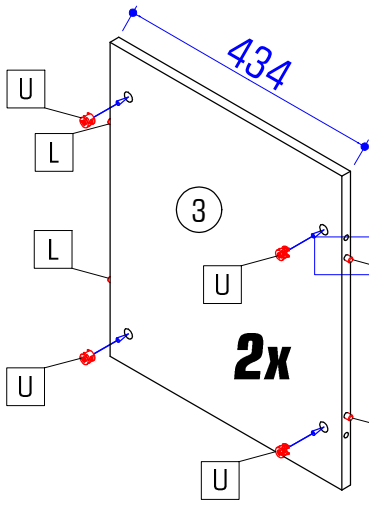
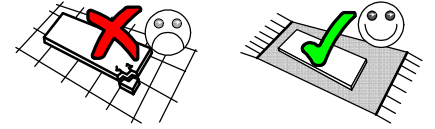

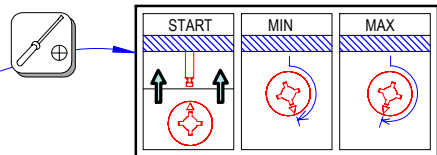
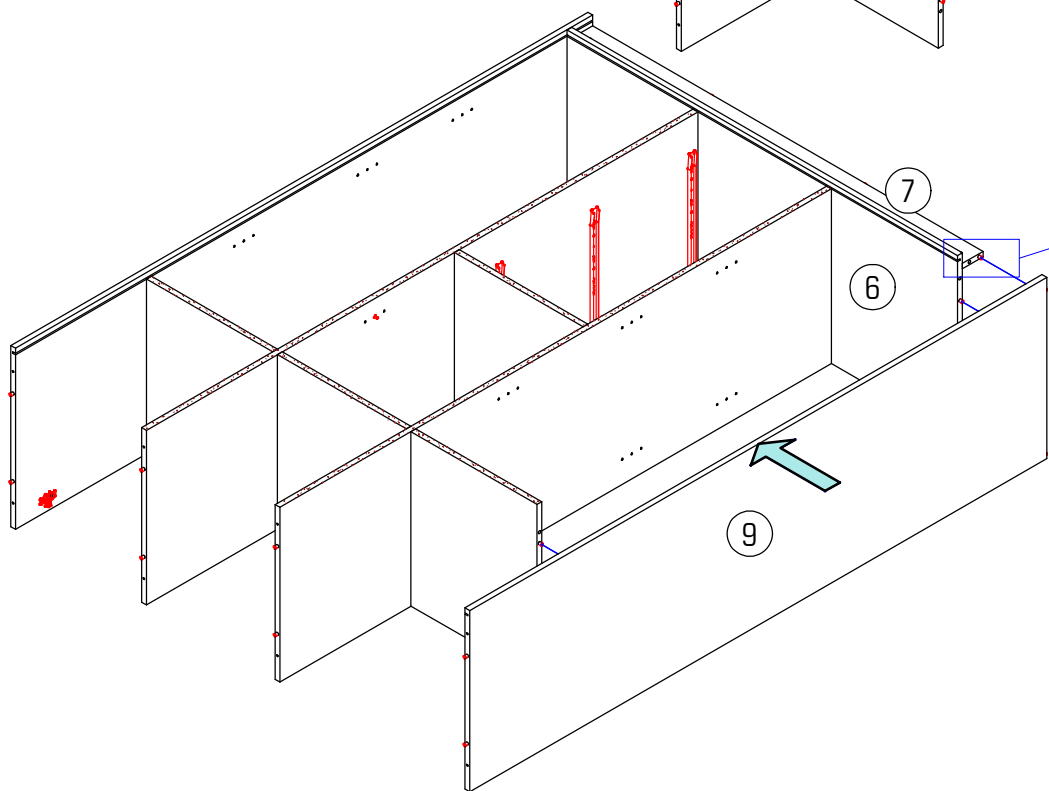
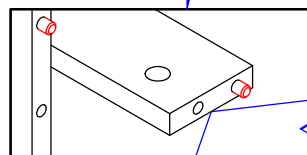
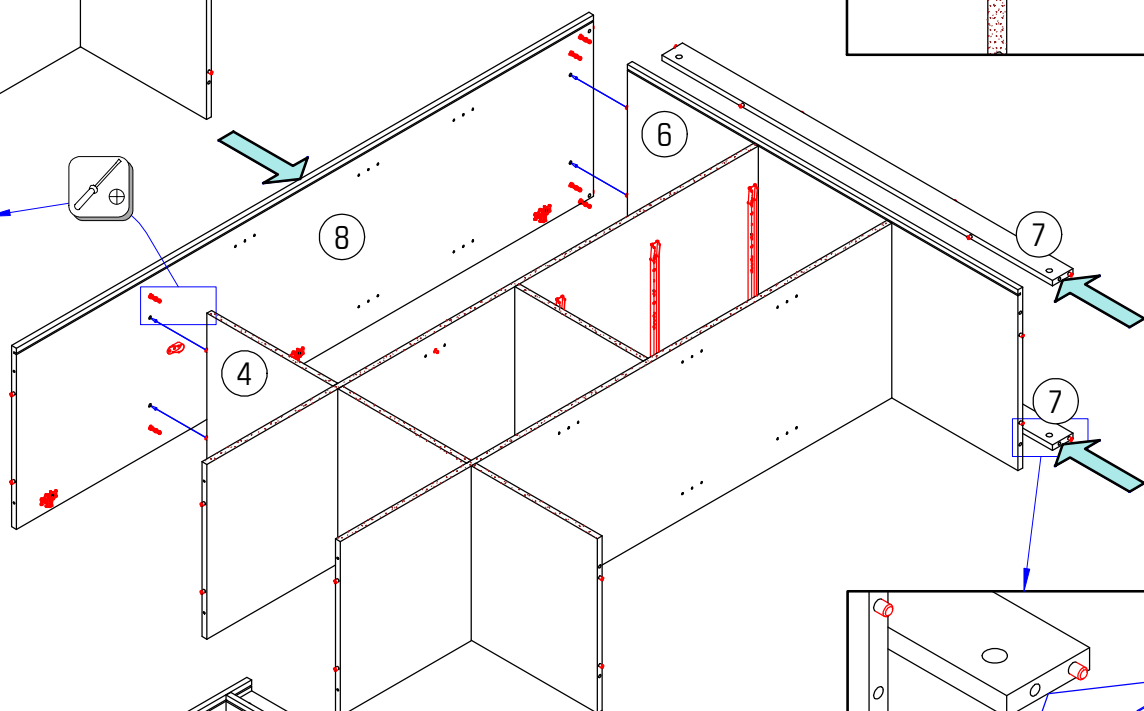
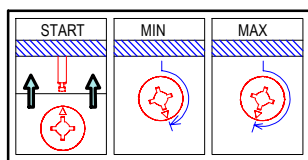
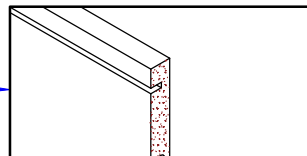
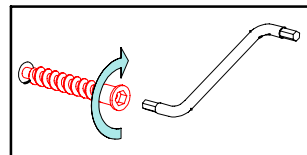
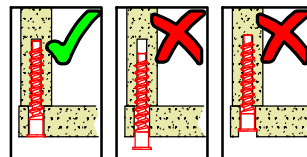
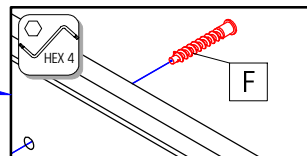
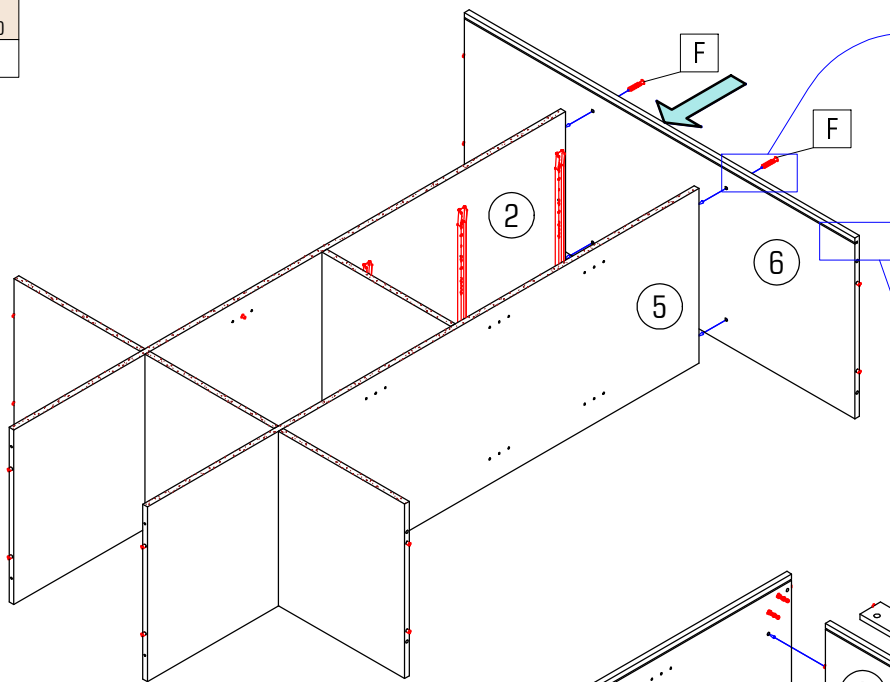
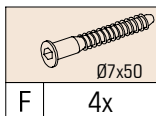

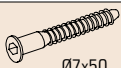

Ø7x50

F



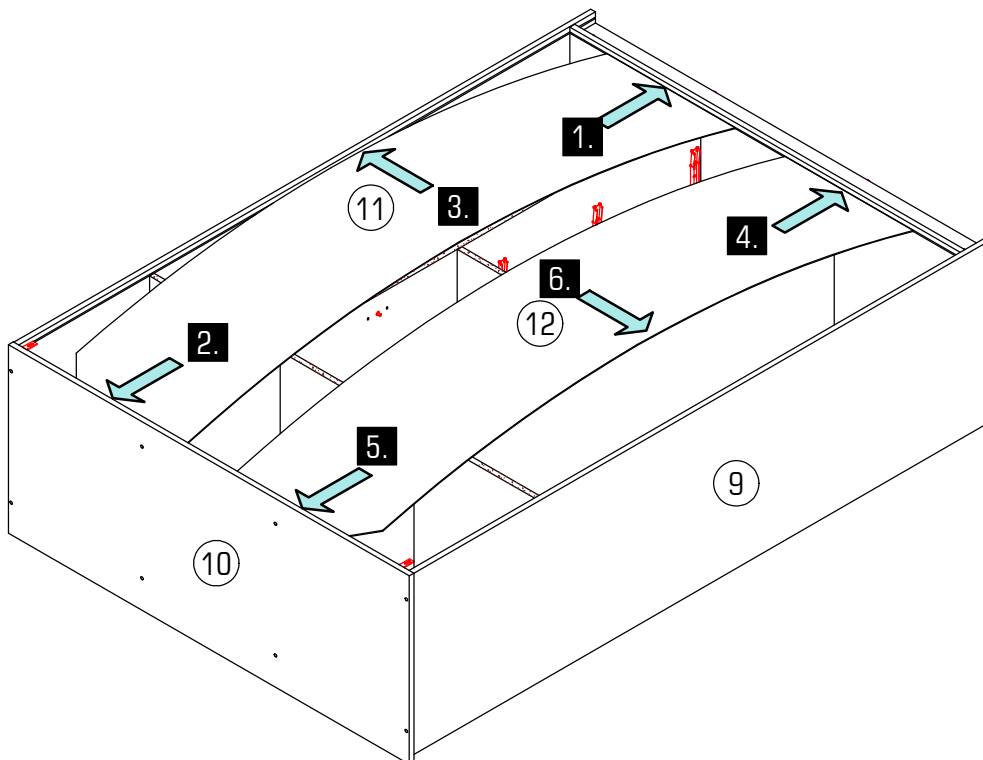
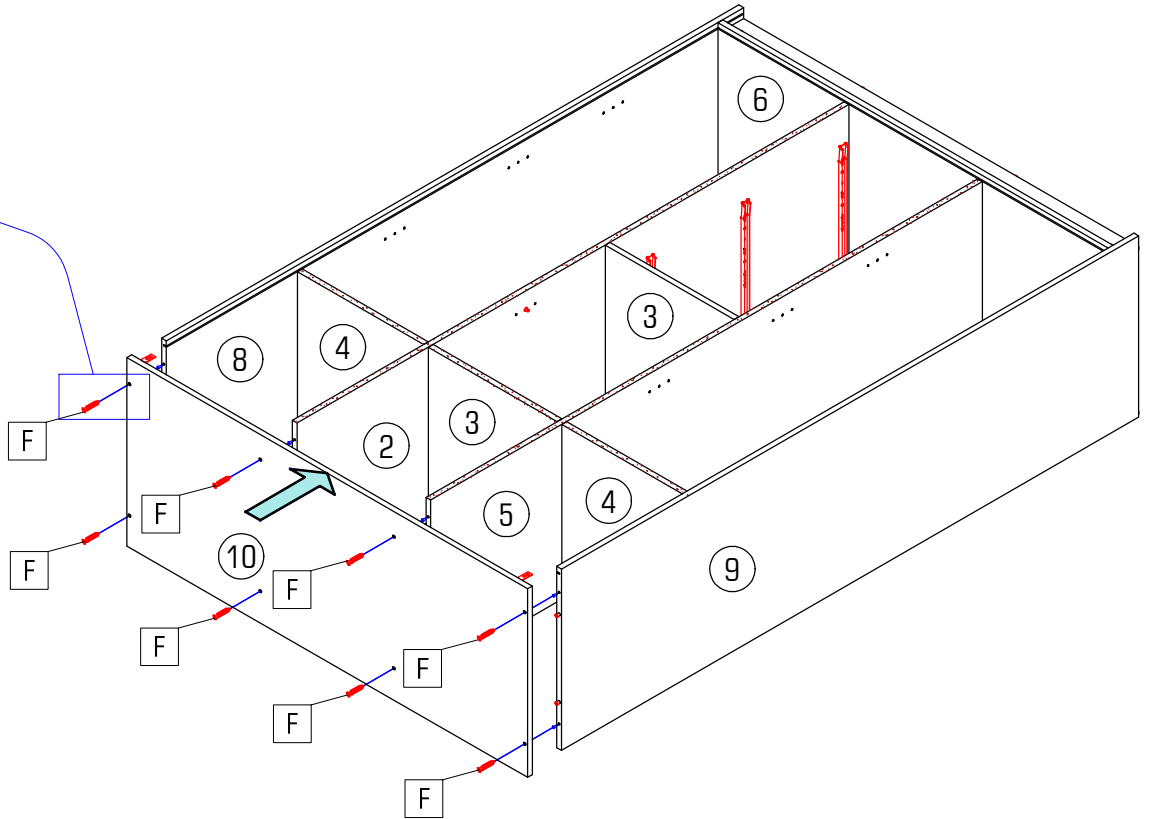
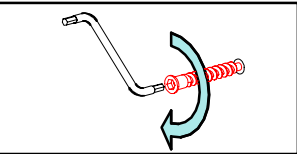
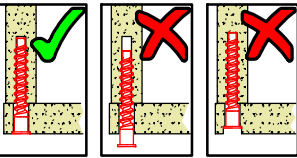
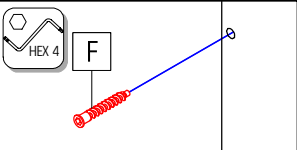

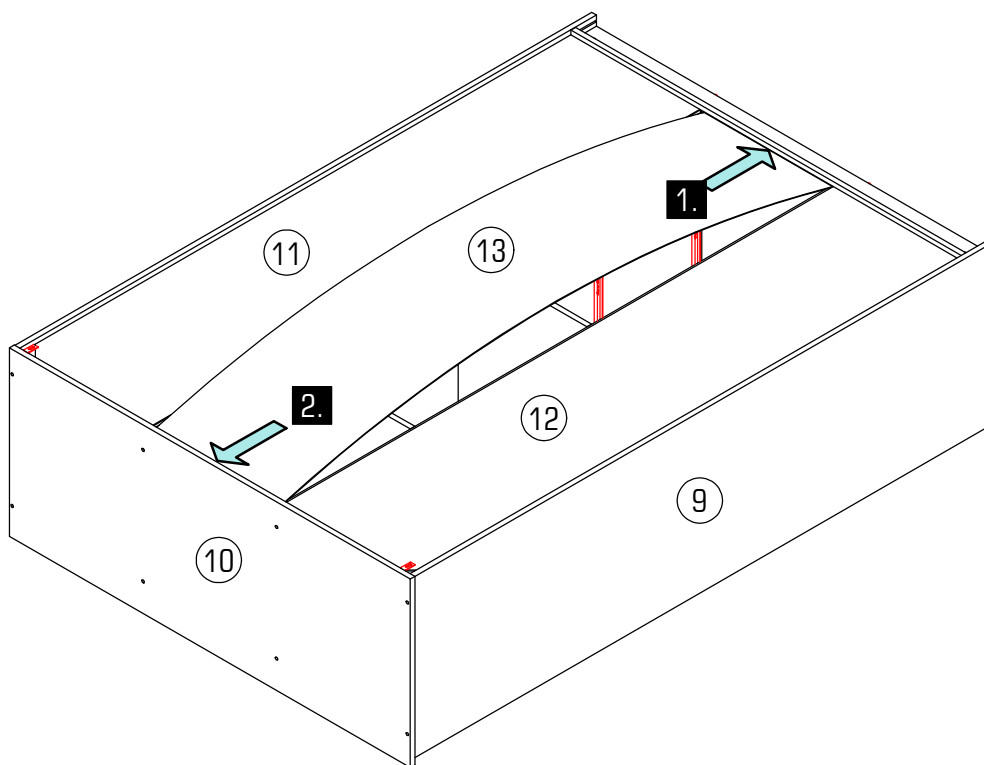
8x



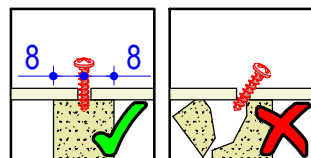
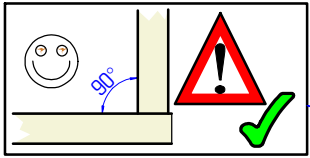
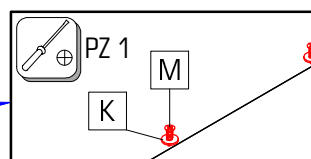
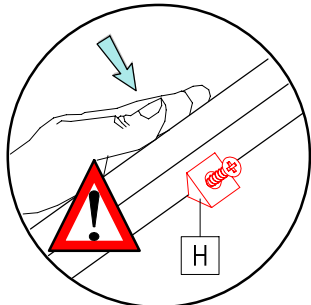
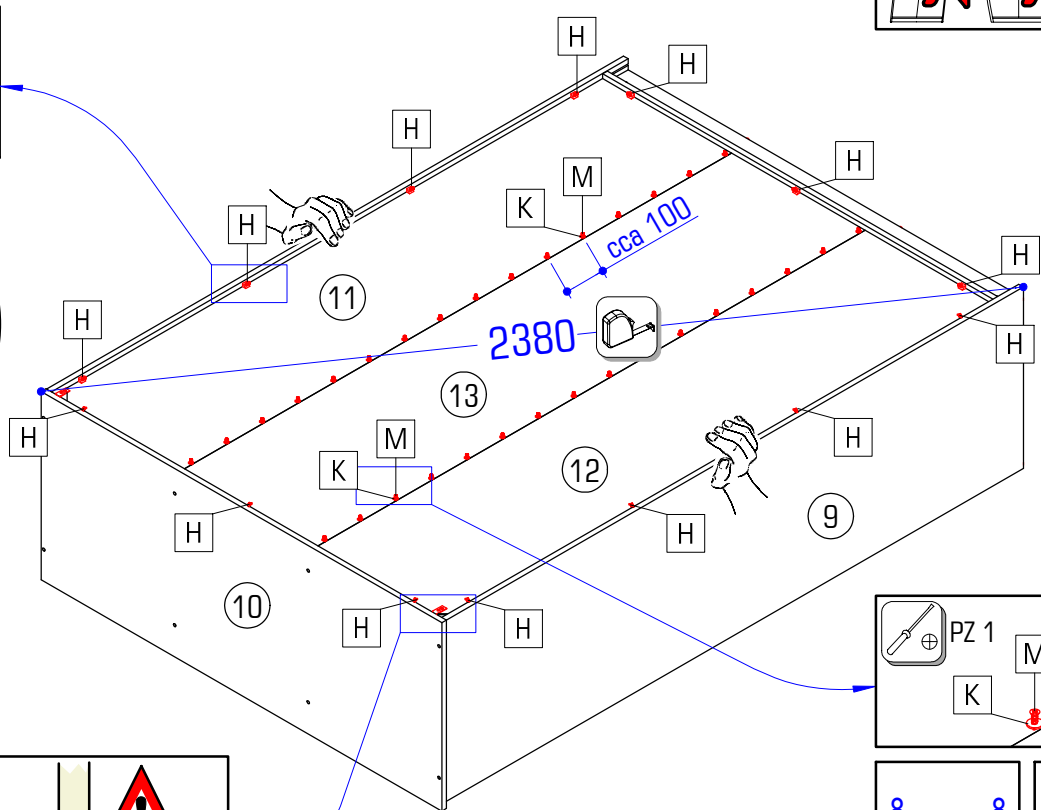
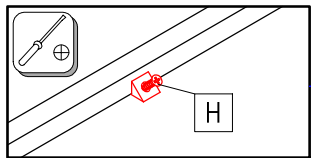
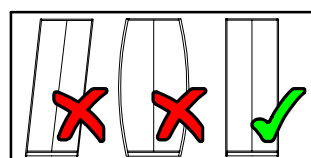
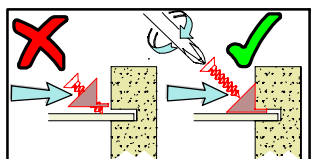
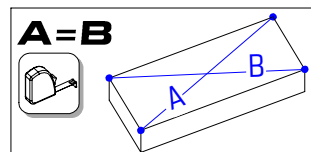

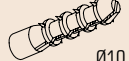
H	14x	K	32x	M	32x
			3,0		Ø2,5x16

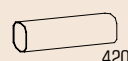

				
Ø5,0x50	Ø10	Ø3,5x16	420	
B1	2x	B2	2x	E
				2x
			W	2x
				J
				16x

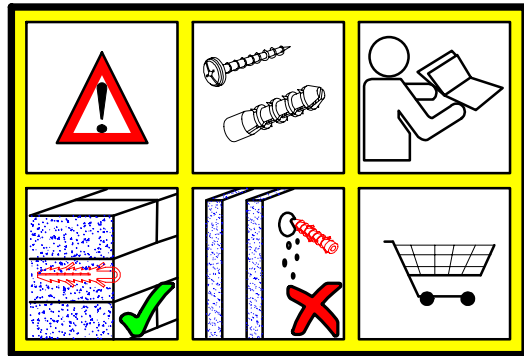
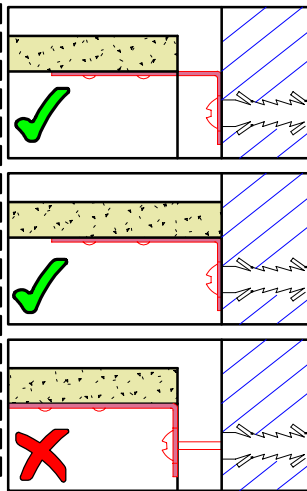
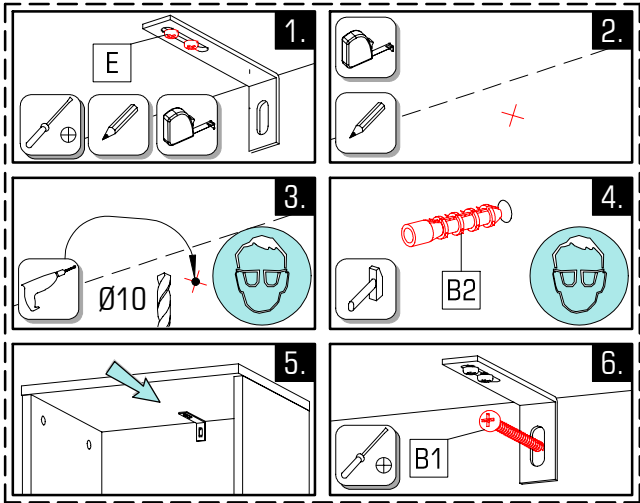

**PL** Uwaga! Ścianę należy sprawdzić przed montażem. Dołączona uniwersalna kołki rozporowe są odpowiednie tylko do stosowania w mocnych murach, takich jak beton lub cegła. Nie rób za pomocą kołków ozporowych murowanych, takich jak pustak, lekka kostka, powierzchnie takie jak płyty gipsowo-kartonowe lub inne systemy ram. Jeśli dotyczy, muszą to być określone kołki rozporowe być użyty! Są one dostępne w specjalistycznym sklepie niezgodność, producent / sprzedawca lub importer nie ponoszą odpowiedzialność.

**DE** Achtung! Die Wandbeschaffenheit ist vor der Montage unbedingt zu prüfen. Die beigelegten Universaldübel sind ausschließlich nur zur Verwendung für festes Mauerwerk wie Beton/Ziegel. Die Mauerdübel dürfen nicht bei Mauerwerk wie Hohlraumziegel, Leichtbausteinen, Gipskartonplatte oder anderer Rahmenbauweise verwendet werden. Bei diesen Mauerwerken sind gegebenenfalls Spezialdübel zu verwenden! Diese sind in einem Fachgeschäft erhältlich. Bei Nichterhaltung wird seitens Produzenten/Händler und Importeur keine Haftung übernommen.

**EN** Caution! The wall must be examined before assembly. The included universal wall plugs are only suitable for using in firm masonry such as concrete block or brick. Do not using the wall plugs masonry such as hollow brick, lightweight block, surfaces such as gypsum plasterboard or other framing systems. If applicable, particular wall plugs must be used! These are available at a specialised store (hardware store). In case of non-compliance, the manufacturer/retailer or importer do not assume liability.

**RO** Prudență! Zidul trebuie examinat înainte de asamblare. Prizele de perete sunt adecvate numai pentru utilizarea în zidărie fermă, cum ar fi betonul bloc sau cărămidă. Nu folosiți zidăria de perete, cum ar fi caramida goală, blocul ușor, suprafețe cum ar fi gips-carton sau altă încadrare sisteme. Dacă este cazul, trebuie folosite anumite prize de perete! Acestea sunt disponibile la un magazin specializat (magazin de hardware). În caz de nerespectare, producătorul / vânzătorul cu amănuntul sau importatorul nu își asumă răspunderea.

**HR** Pažnja! Prije montaže obvezno provjerite svojstvo zida. Priložene univerzalne tiplje namijenjene su isključivo za masivne zidove od betona/opeke. Tiplje za masivne zidove ne smiju se koristiti za zidove kao npr šupljina opeka laki sastavni elementi, gips-kartonske ploče ili drugi modularni načini gradnje. Za te zidove potrebne su eventualno posebne tiplje! Iste su dostupne u specijaliziranim trgovinama građevinskim materijalom. U slučaju nepridržavanja prethodno navedenih napomena, proizvođač/trgovac i uvoznik ne preuzimaju odgovornost!

**CZ** Upozornění! Před montáží je nutné zkontrolovat stav stěny. Přiložené univerzální hmoždinky jsou určeny pouze k použití pro pevné zdivo jako beton/cihly. Hmoždinky do zdi se nesmí používat u dutinová cihla, zdiva jako pórovitý stavební kámen, sádrokartonová deska nebo jiný měkký materiál. U těchto zdív jsou nutné použít speciální hmoždinky! Jsou k dostání v speciálních prodejních se stavebním materiálem. Při nedodržání těchto pokynů výrobce/prodejce a dovozce neručí za způsobené škody.

**SI** Pozor! Pred montažo preverite stanje stene. Priloženi univerzalni mozniki so izključno samo za uporabo na žvrstnem zidovju, kot sta beton in opeka. Stenski mozniki se ne smejo uporabljati pri zidovju kot so votlino opeke, zidaki za lahko gradnjo, mavčne plošče ali druge okvirne gradnje. Pri teh zidovjih morate v danih primerih uporabljati posebne moznike. Ti so na voljo v specializiranih trgovinah (trgovinah z gradbenim materialom) Pri upoštevanju se s strani proizvajalca/trgovca in uvoznika ne prevzame jamstvo.



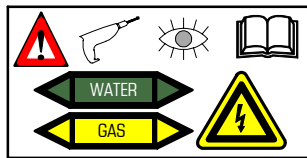
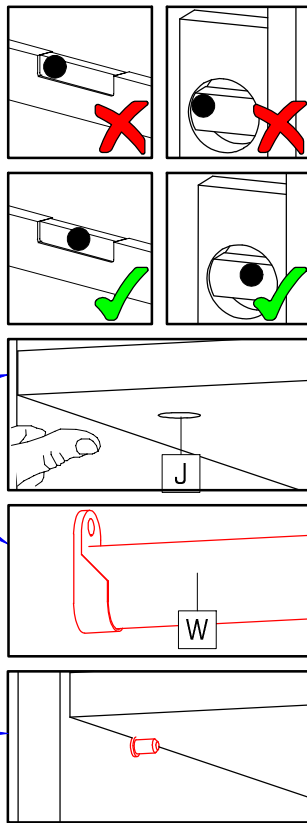
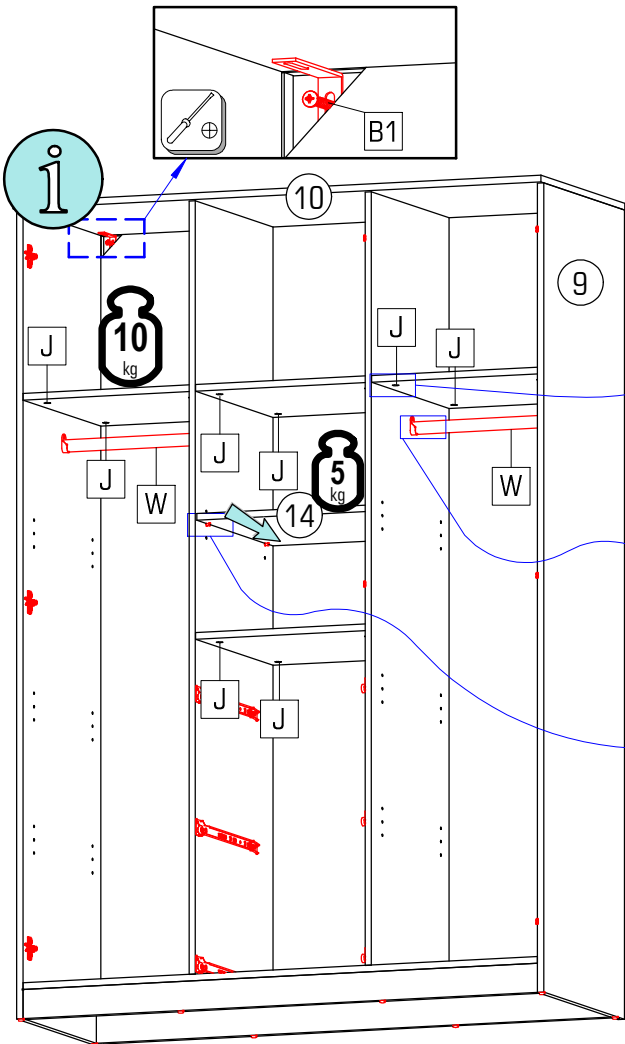

**HU** Vigyázat! Szerelés előtt a falfelületet feltétlenül vizsgálja meg. A mellékelt univerzális tiplje kizárólag stabil falazathoz használható mint például beton/tégla. A fali tiplje nem használható könnyű építőkövekhez, üreg tégla, gipszkarton lapokhoz vagy más fávázás építményekhez. Ezekhez a falfelületekhez csak speciális tiplje használhatóak, melyek szaküzletekben (barkácsáruházakban) beszerezhetőek. Fentiek figyelmen kívül hagyása esetén a gyártó/kereskedő vagy forgalmazó nem vállal felelősséget.

**SK** Upozornenie! Pevnosť steny sa musí pred montážou bezpodmienečne skontrolovať. Priložené univerzálne hmoždienky používajte jedine pre pevné murivo ako je betón/tehla. Hmoždienky sa nesmú používať v prípade ľahkého stavebného muriva, dutá tehla, sádrokartónová doska, alebo iných konštrukcií rámu. U týchto stien je nutné použiť špeciálne hmoždienky! Tieto je možné dostať v špeciálnych predajniach so stavebným materiálom. Pri nedodržaní pokynov nepreberajú výrobcovia/predajci a dodávatelia zodpovednosť za vzniknuté škody.

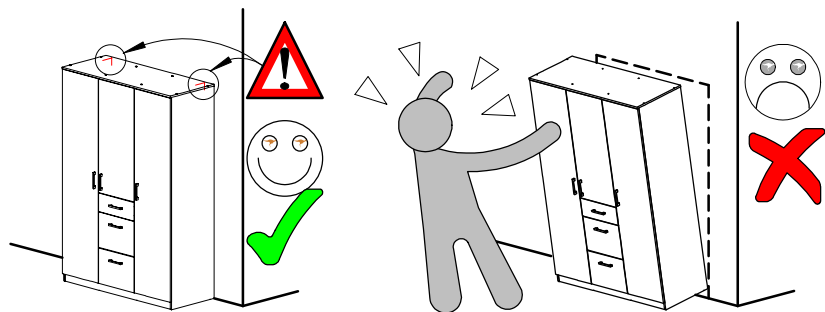

<b>SK</b>	<b>VÝSTRAHA</b>
<b>CZ</b>	<b>VAROVÁNÍ</b>
<b>HR</b>	<b>UPOZORENIE</b>
<b>DE</b>	<b>WARNUNG</b>
<b>HU</b>	<b>FIGYELEM</b>
<b>PL</b>	<b>OSTRZEŻENIE</b>
<b>RO</b>	<b>AVERTIZARE</b>
<b>EN</b>	<b>WARNING</b>
<b>SI</b>	<b>OPOZORILO</b>



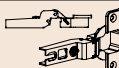
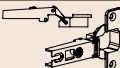

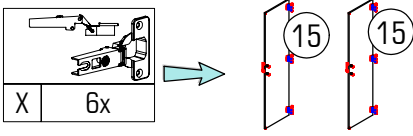
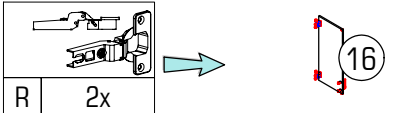

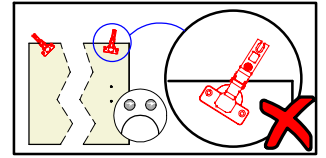
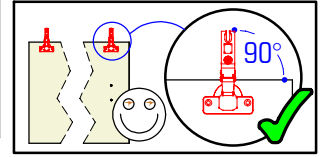
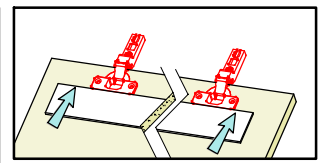
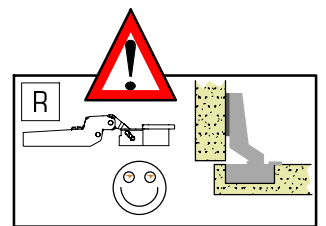
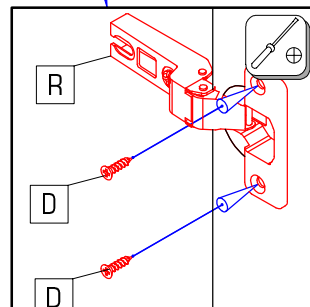
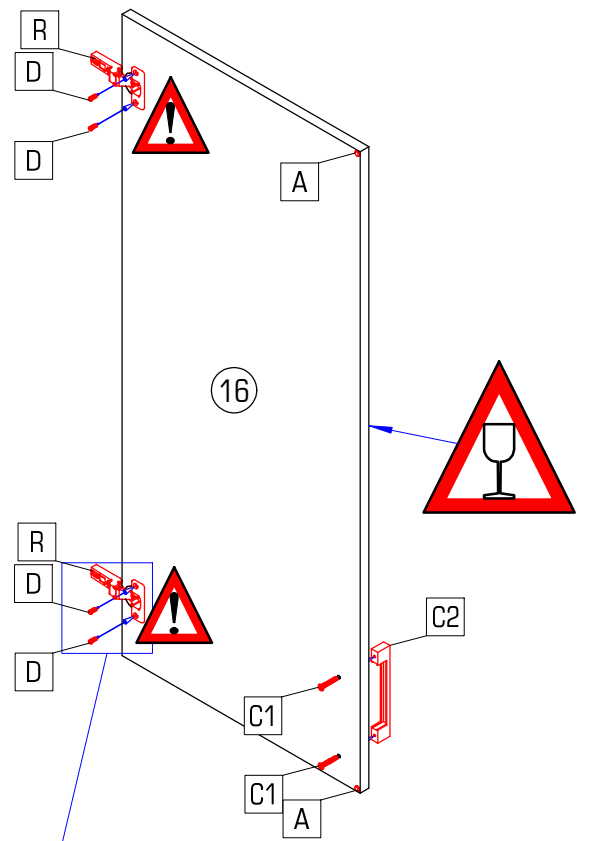
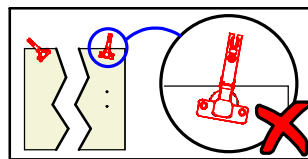
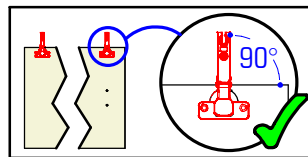
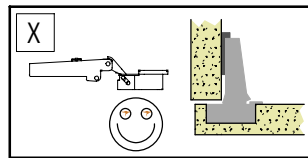
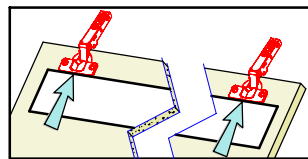
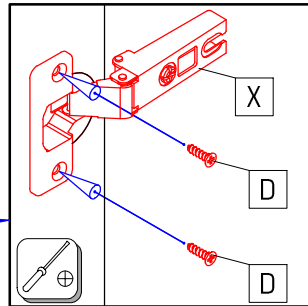
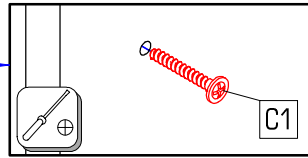
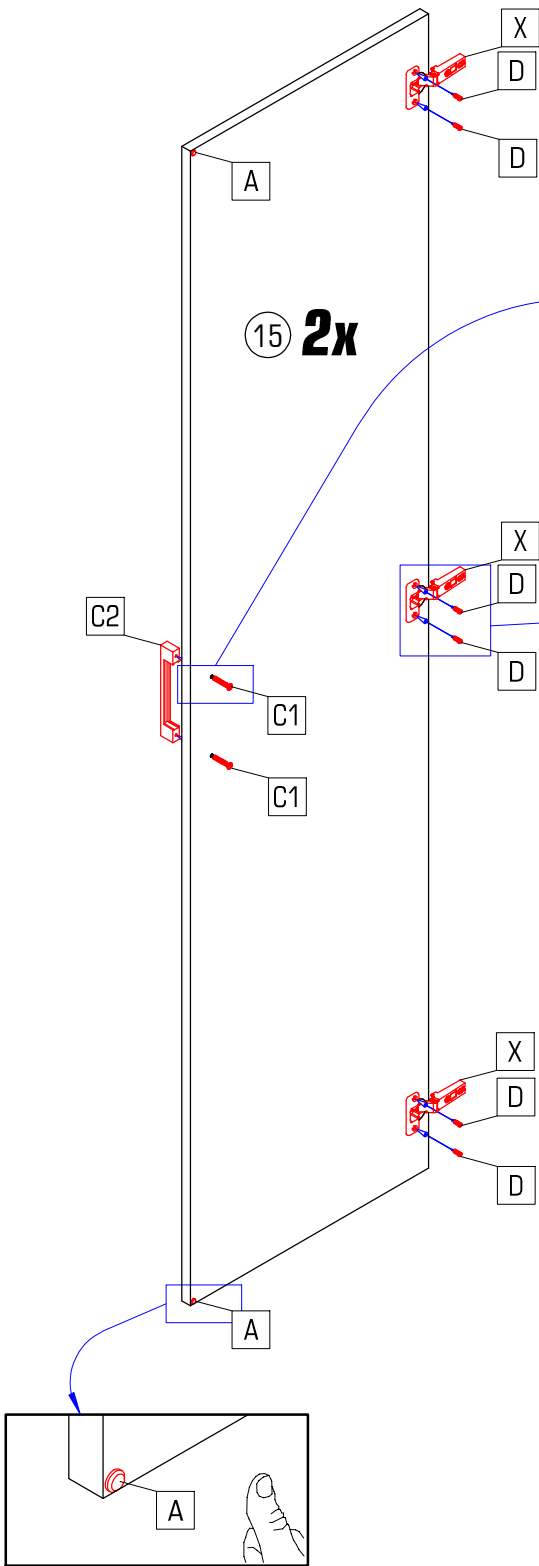
					
A	3x	C1	6x	C2	3x
				D	16x
				R	2x
				X	6x

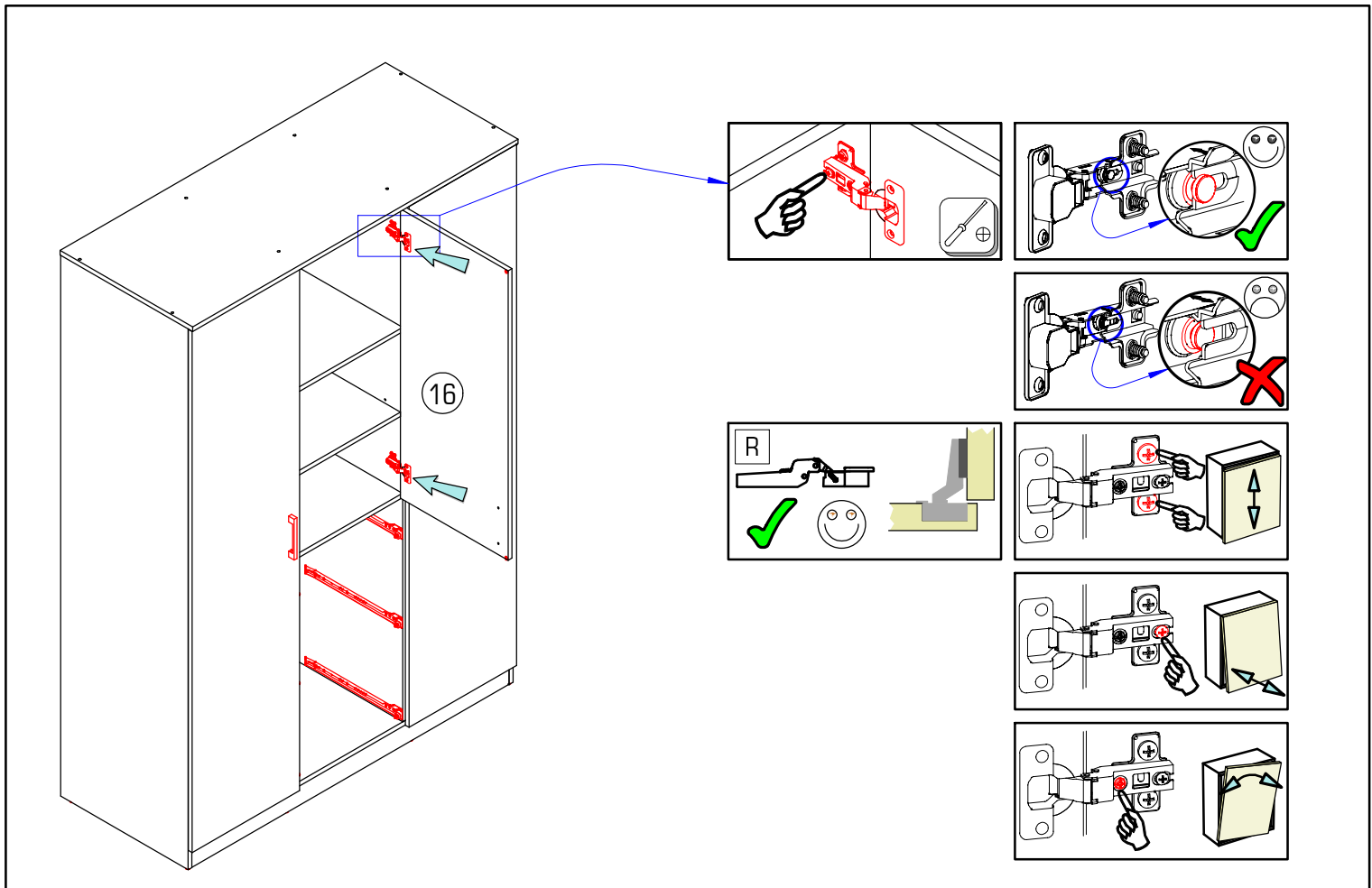
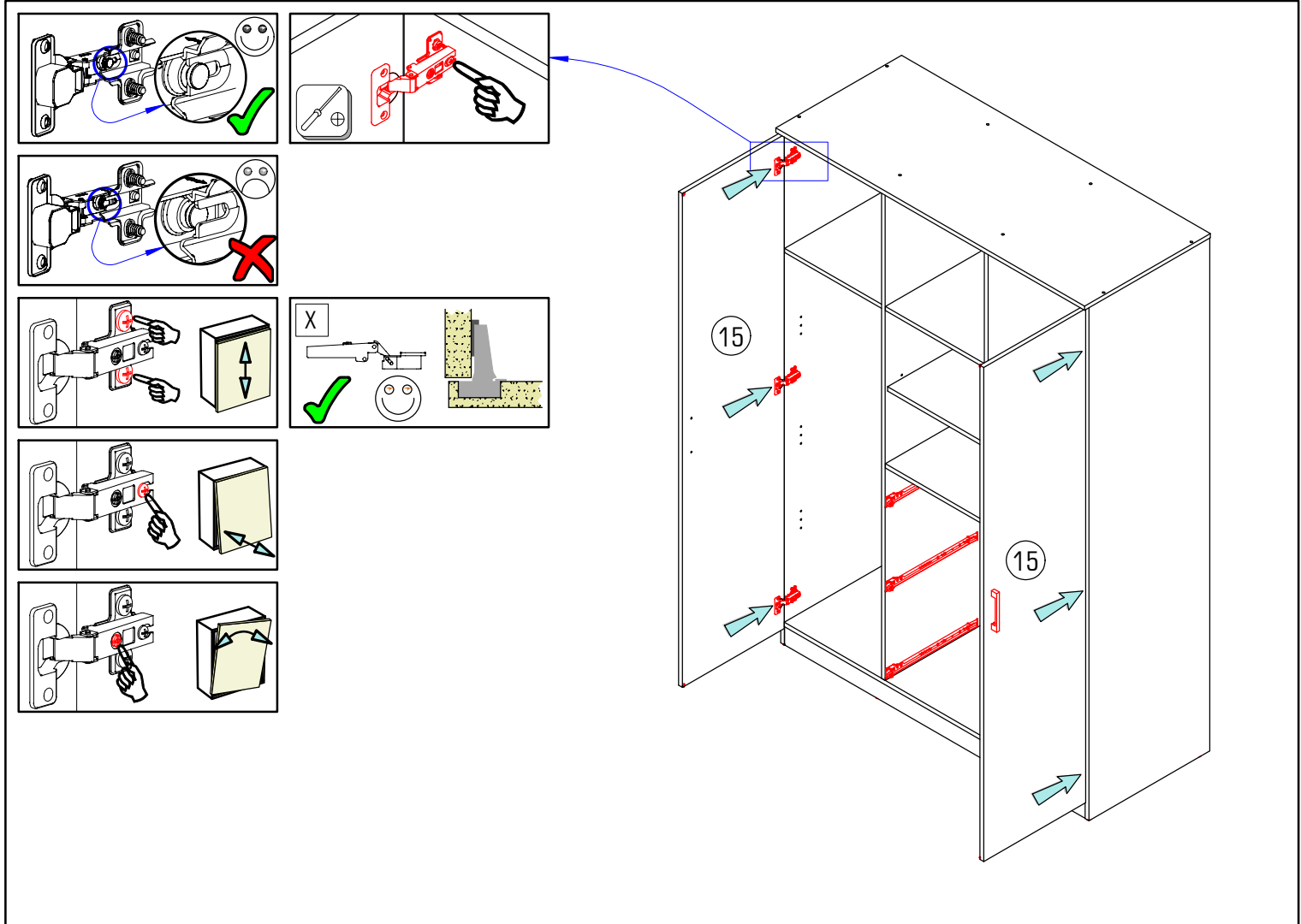





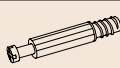

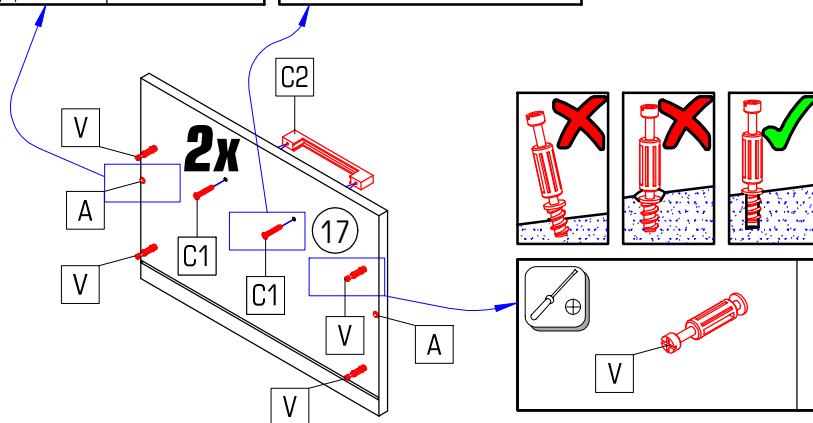
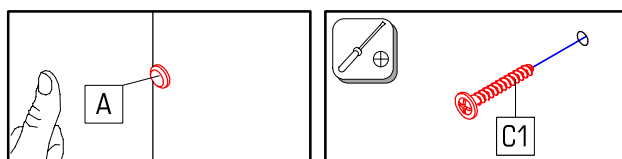
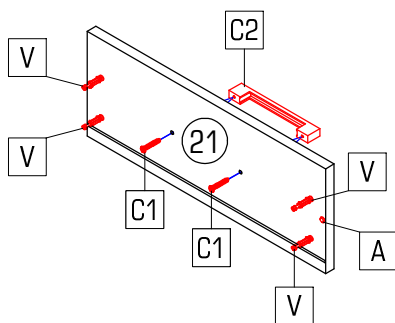
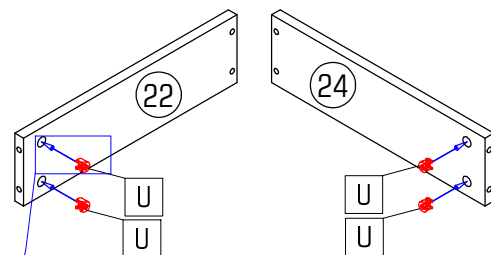
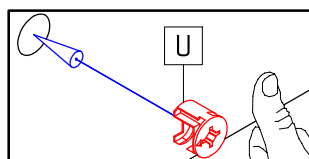
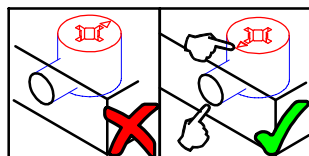
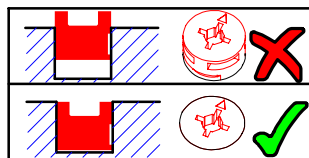
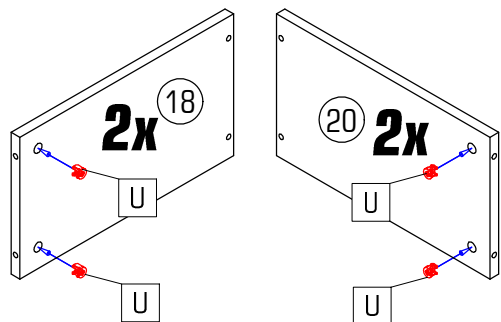
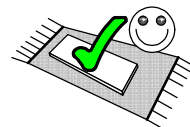
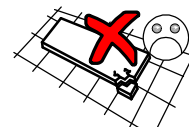



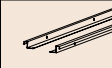

				
Ø8	Ø4x30	L=146	Ø15x13	
A	3x	C1	6x	C2
			3x	U
				12x
				V
				12x



				
Ø3,5x15	Ø3,5x16	Ø7x50		400
D 6x	E 4x	F 4x	J 4x	Z2 1x

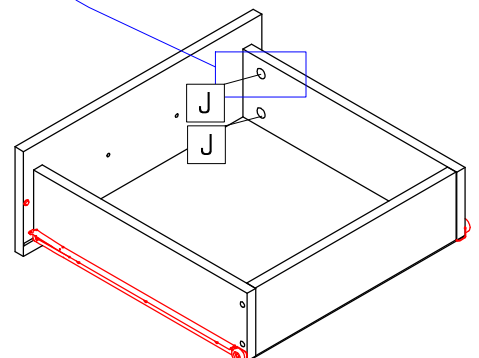
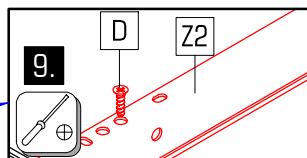
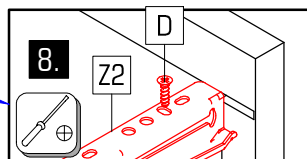
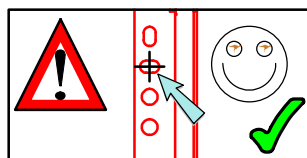
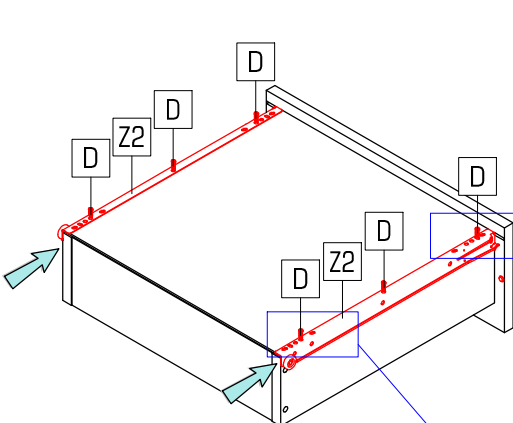
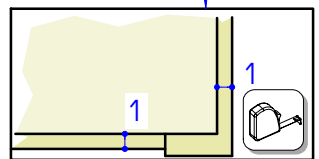
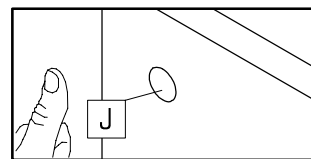
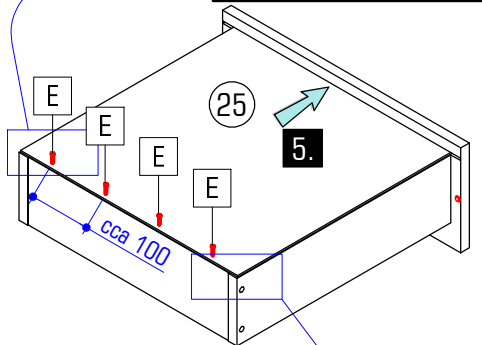
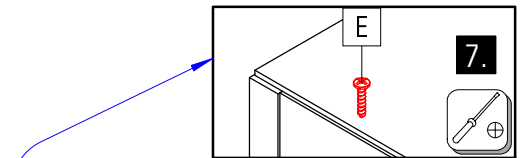
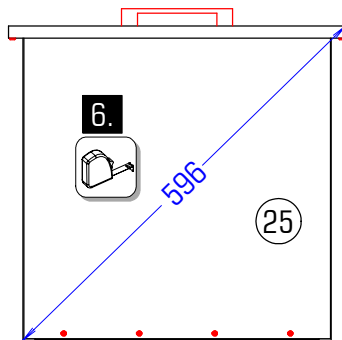
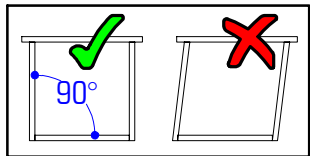
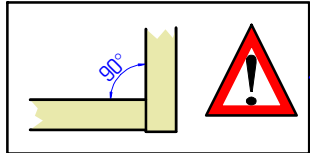
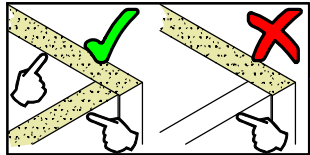
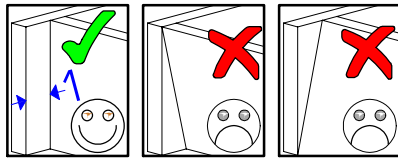
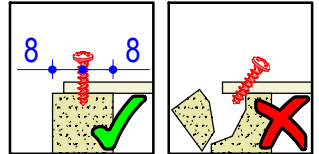
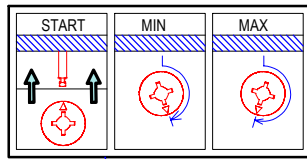
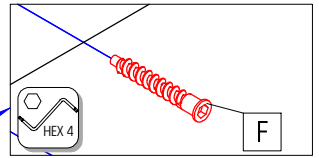
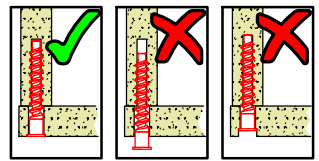
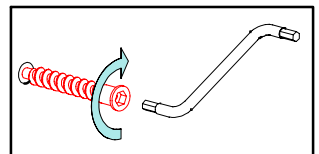
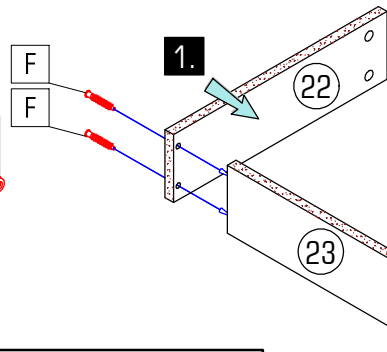
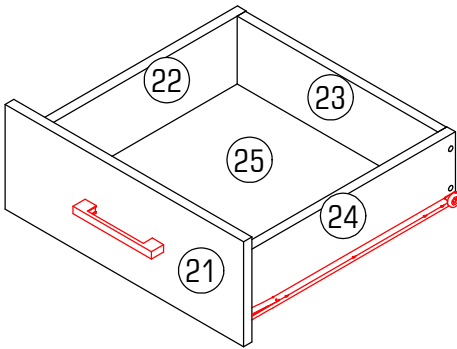

					400
D	12x	E	8x	F	8x
			J	8x	Z2
					2x

