

# GLOBO

LIGHTING

[www.globo-lighting.com](http://www.globo-lighting.com)

56201-2

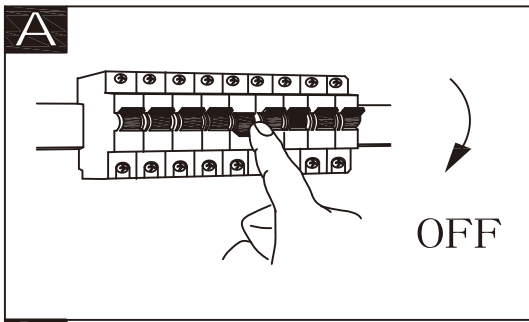

**B**

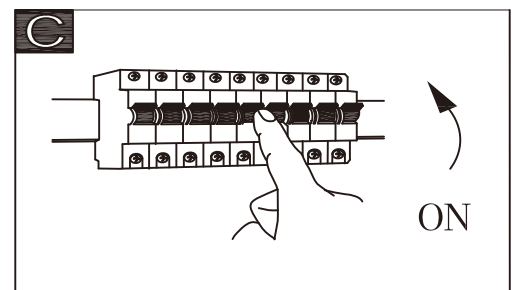
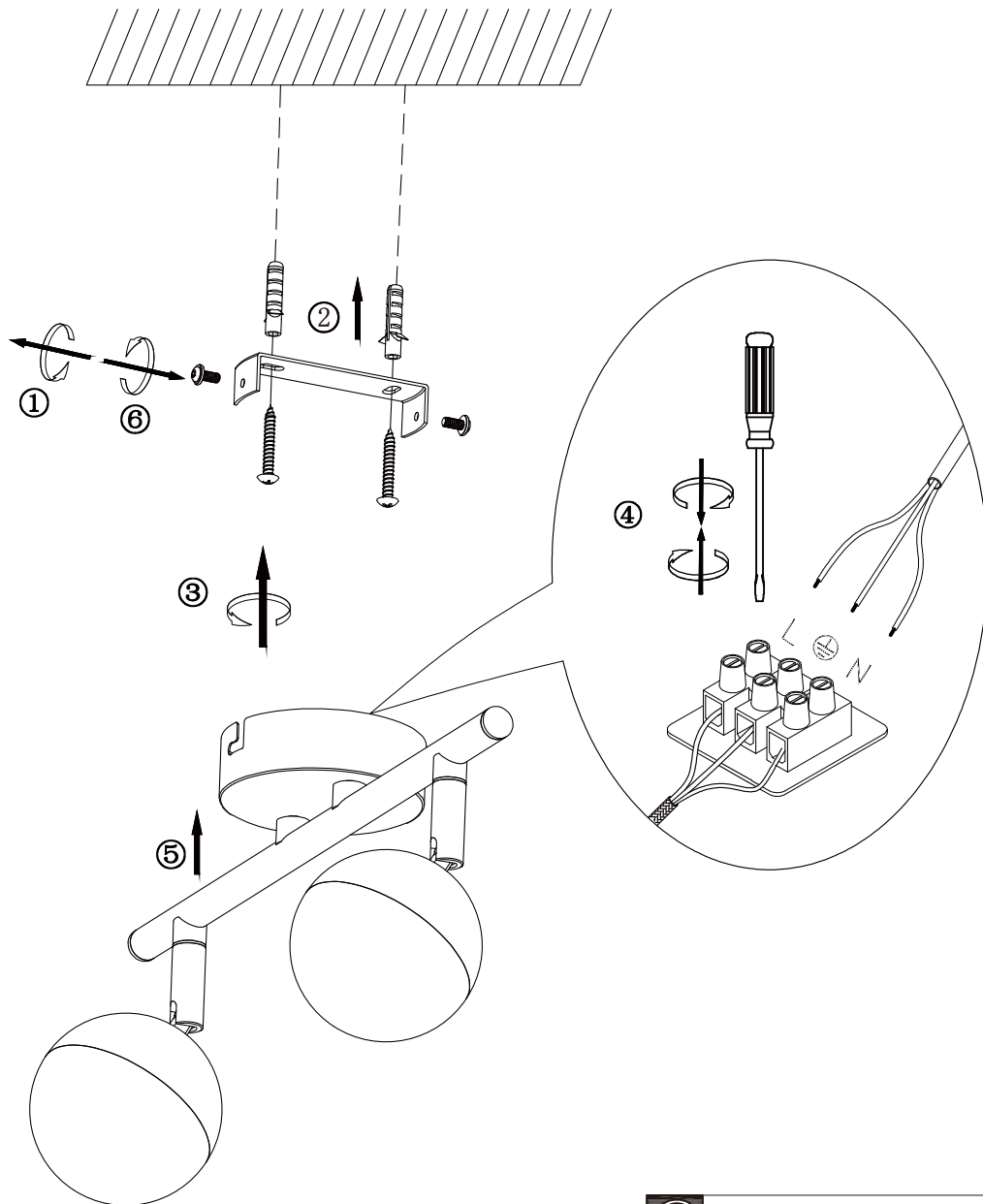

GLOBO Handels GmbH  
St.Peter 38  
A-9184 St.Jakob/Rosental