

UNIT 3600/2346

C 1/1

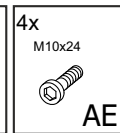

1

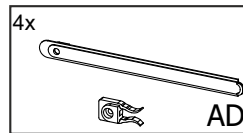
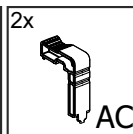
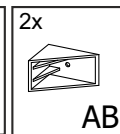
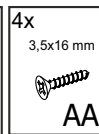
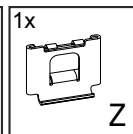
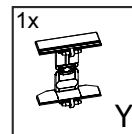
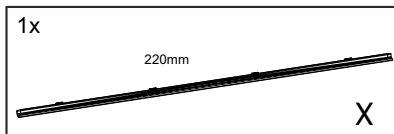
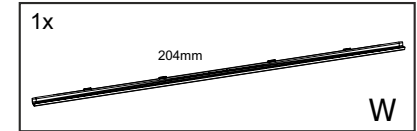
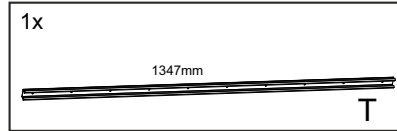
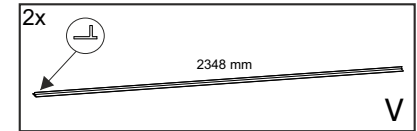
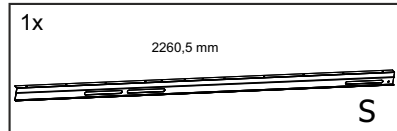
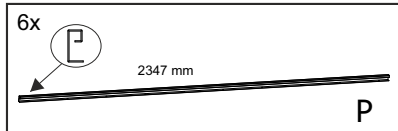
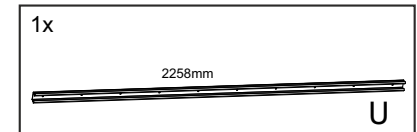
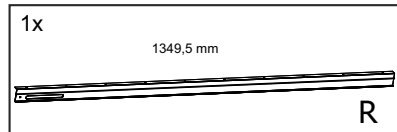
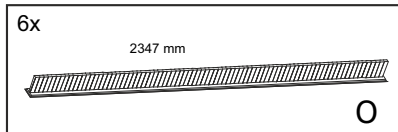
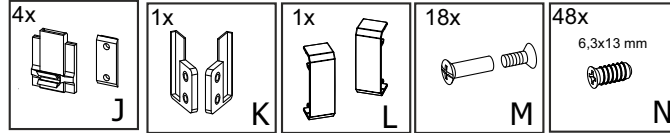
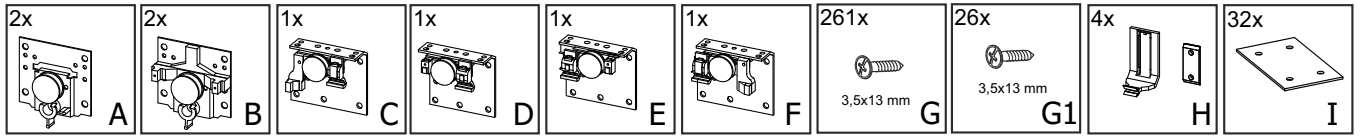
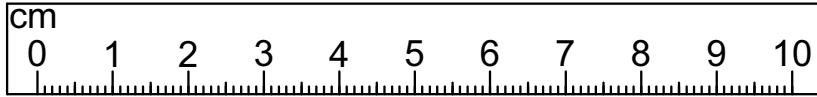
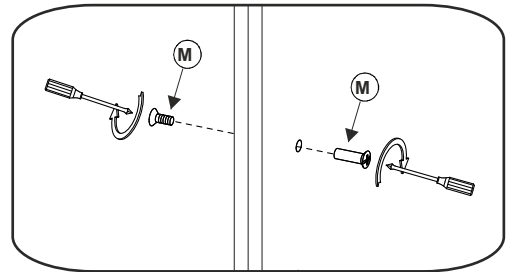
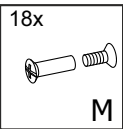
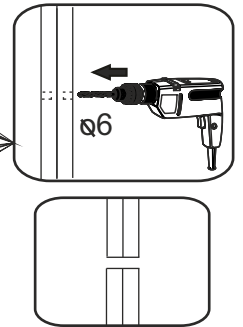
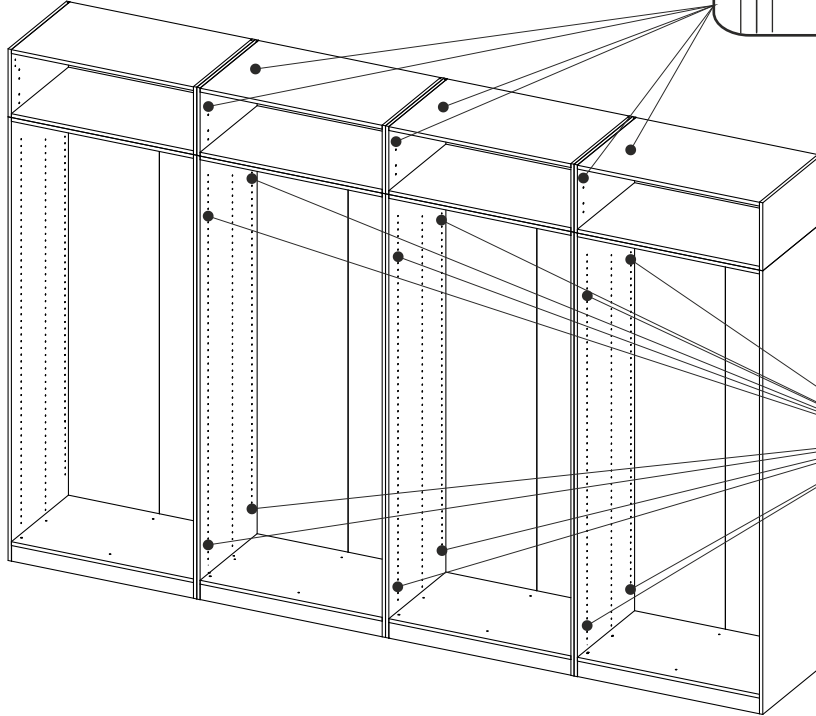
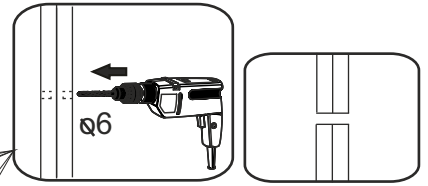
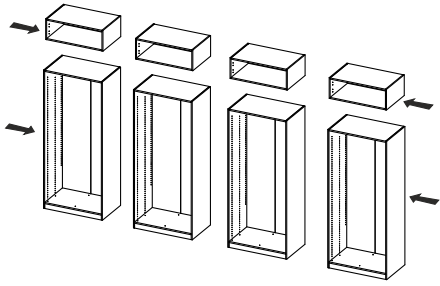

2

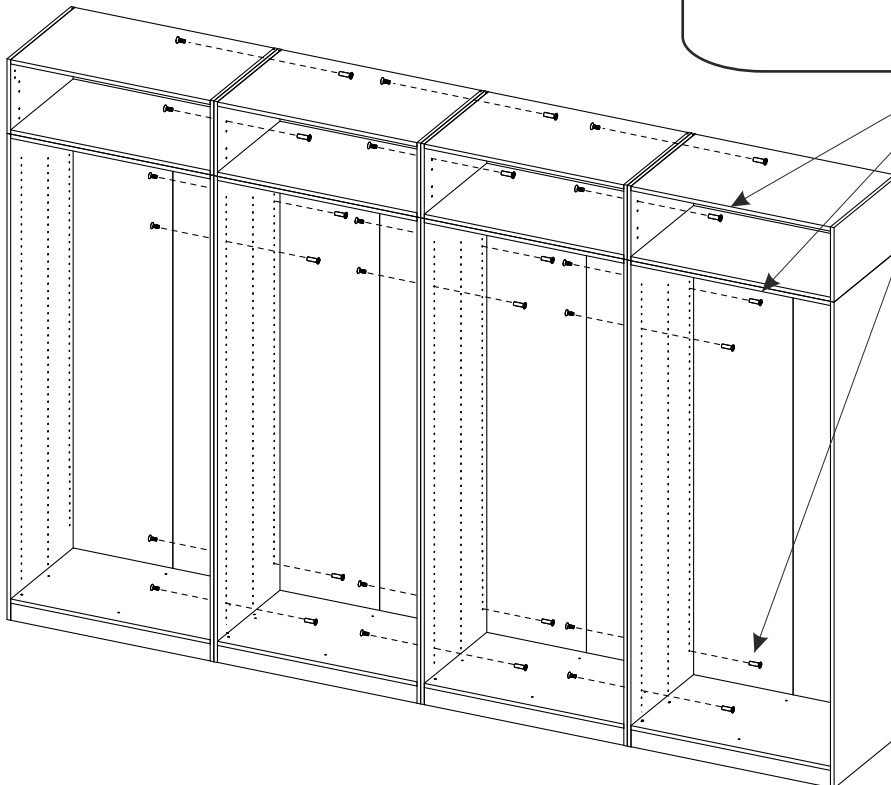

UNIT 3600/2346

3

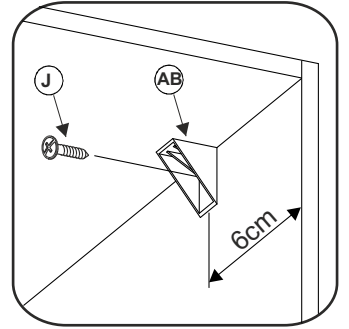
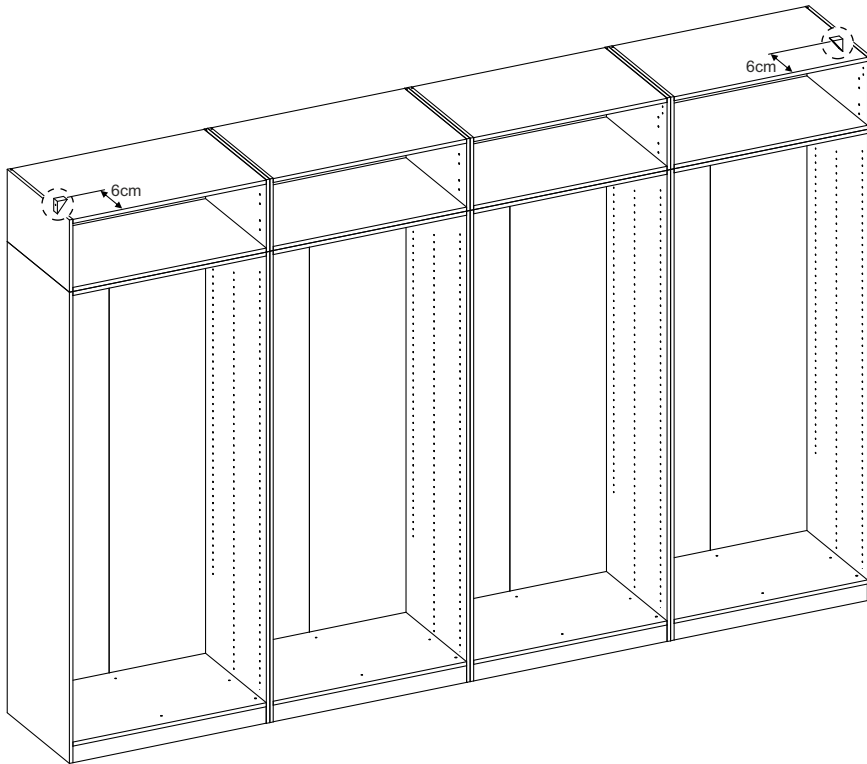
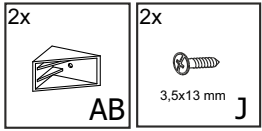

4

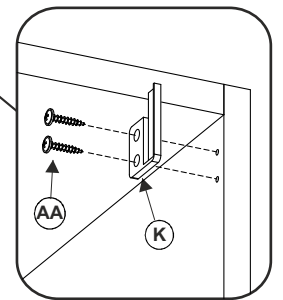
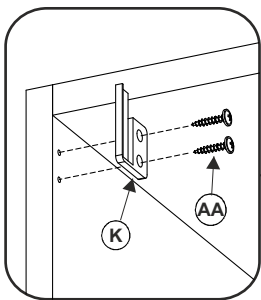
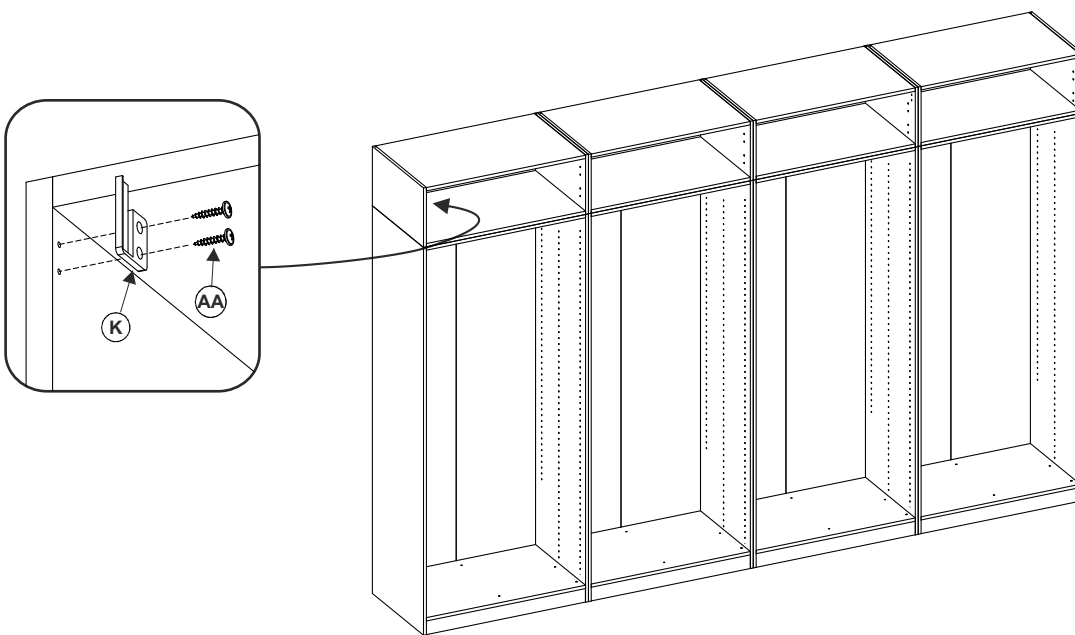
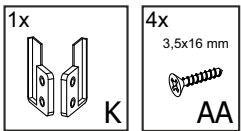

UNIT 3600/2346

5

7x
3,5x13 mm
G

1x 1349,5 mm
R

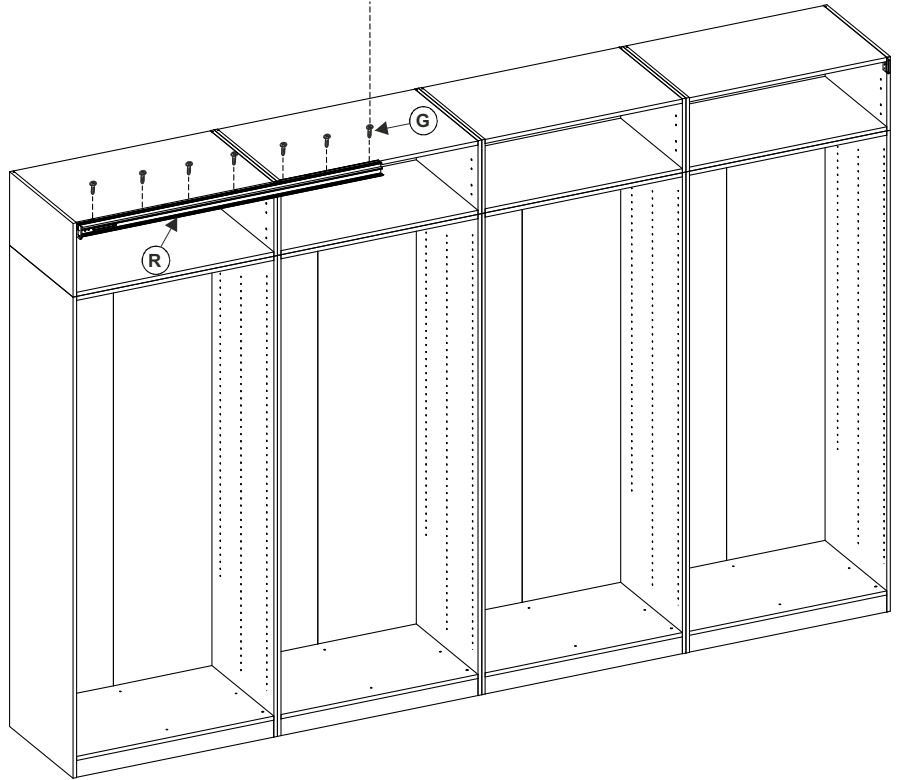
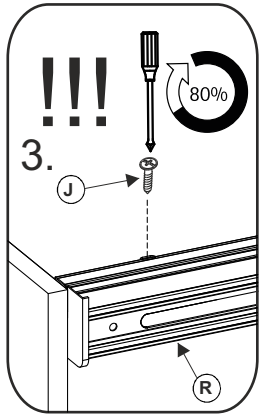
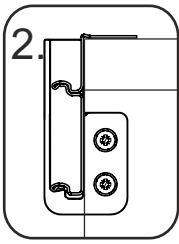
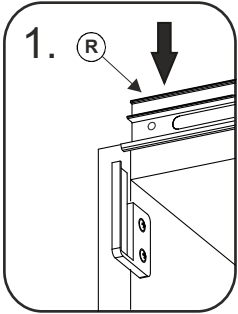
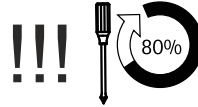

6

11x
3,5x13 mm
G

1x 2260,5 mm
S

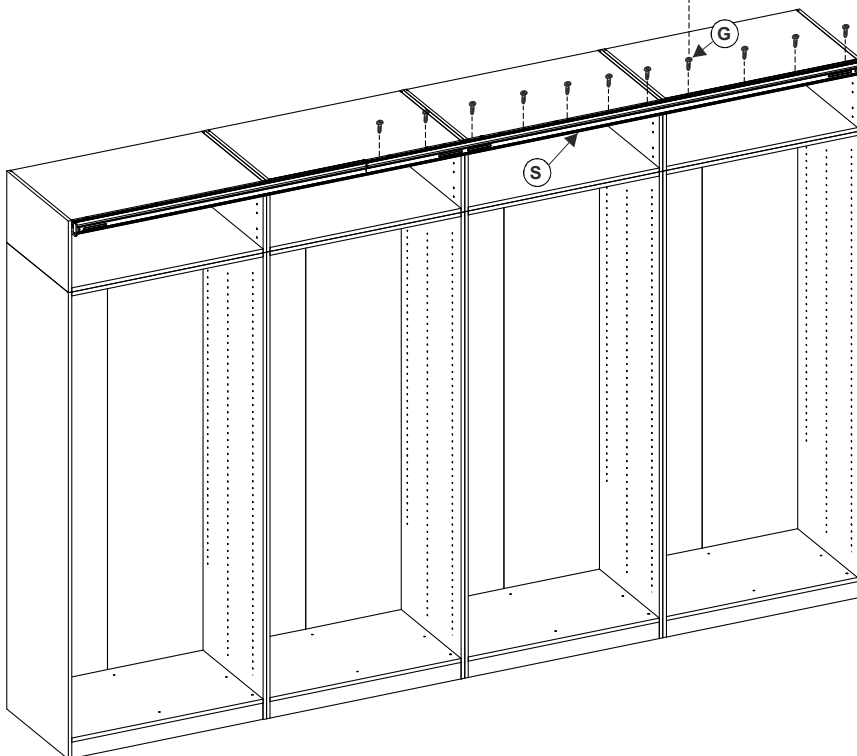
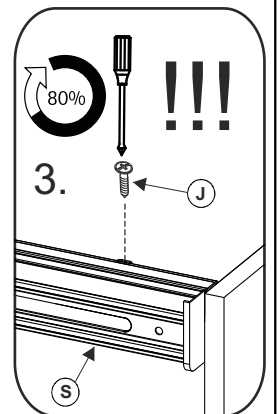
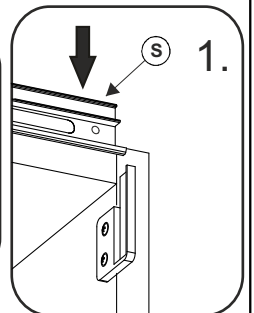
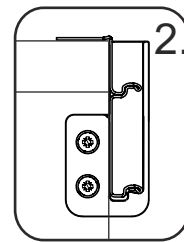

7

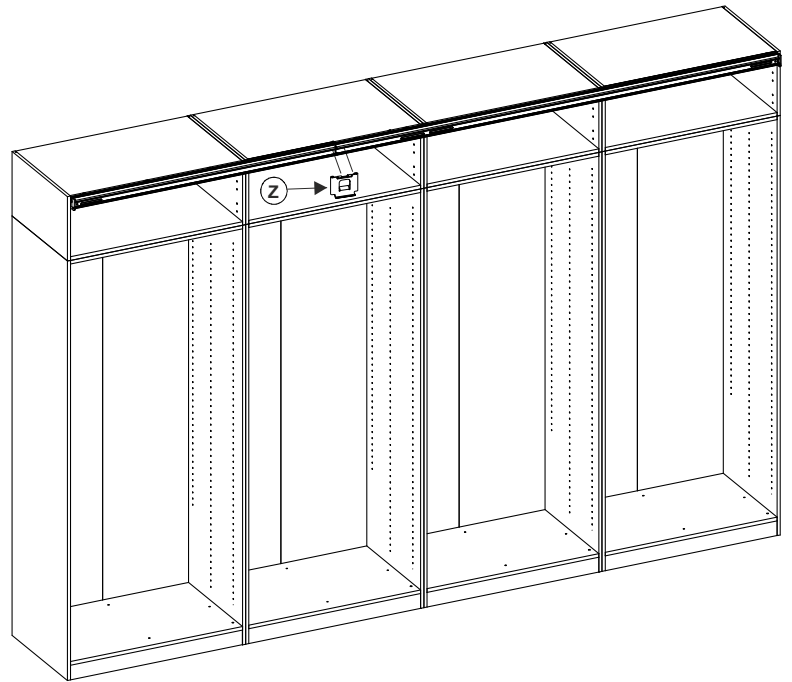
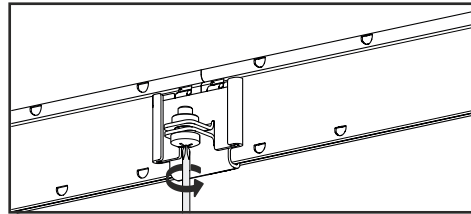
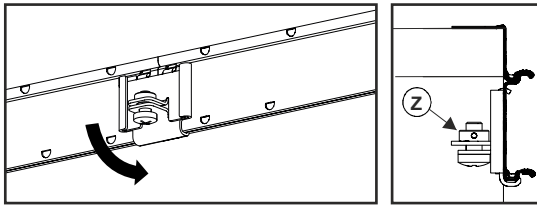
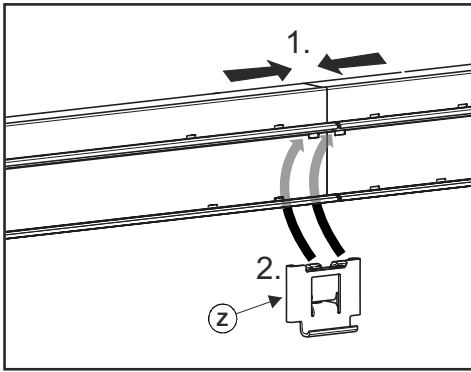
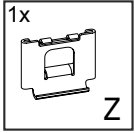

8

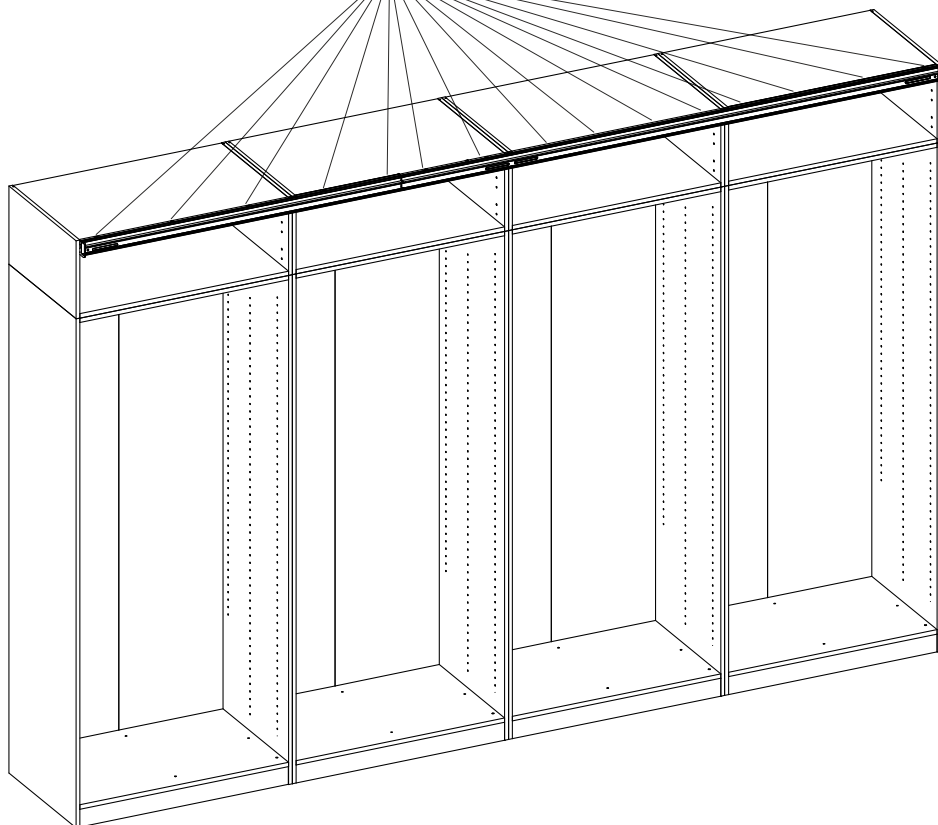
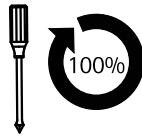

UNIT 3600/2346

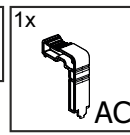
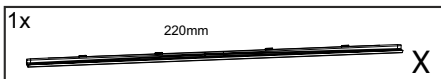

9

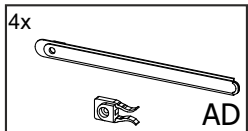
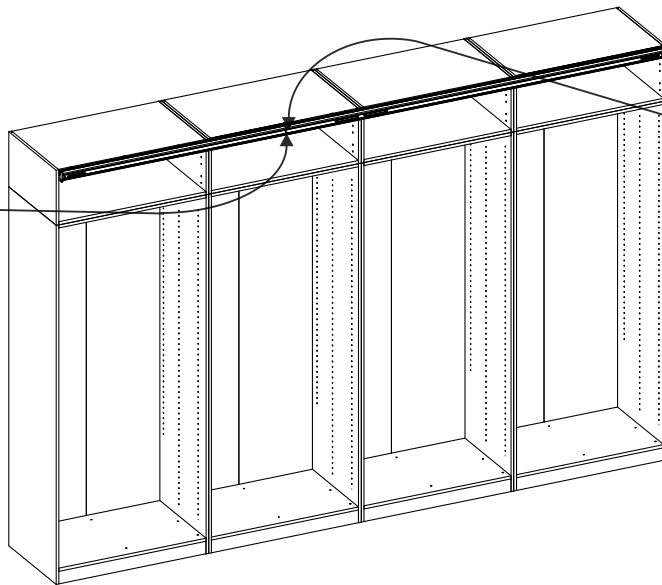
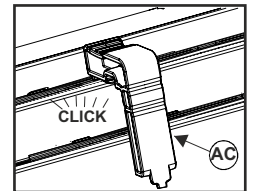
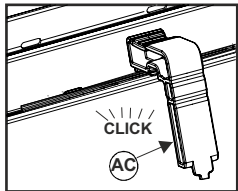
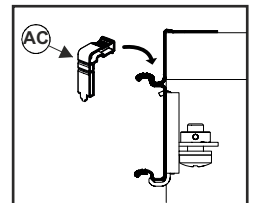
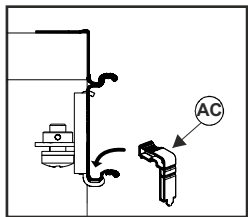
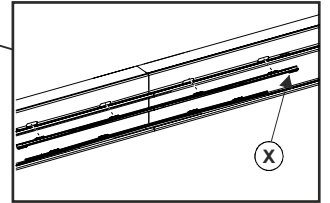
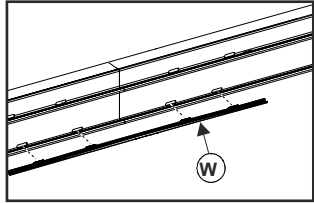
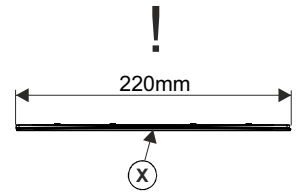
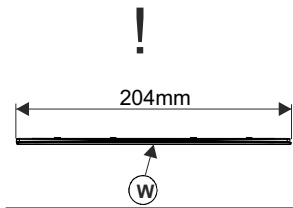

10

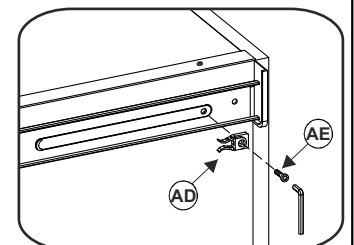
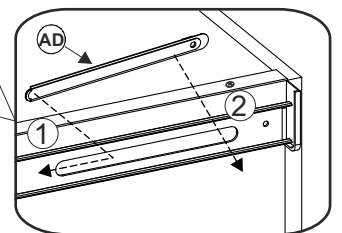
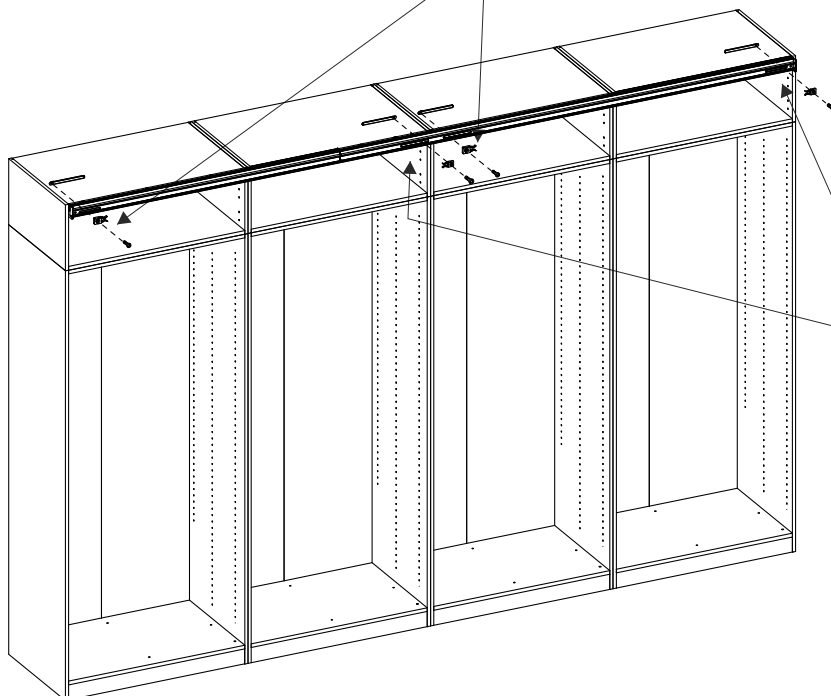
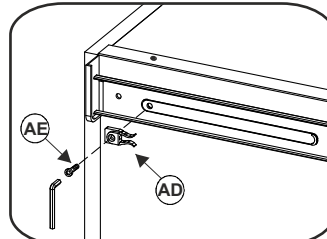
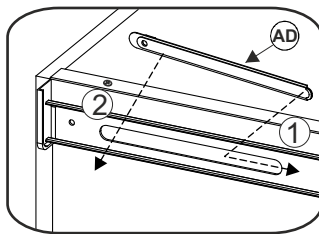

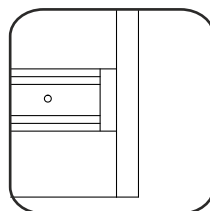
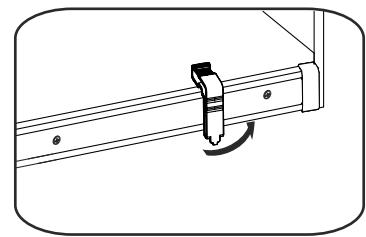
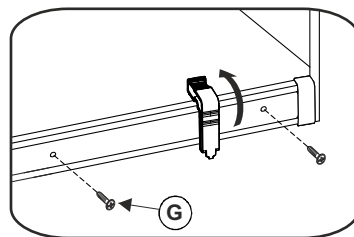
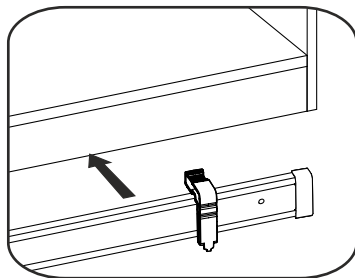
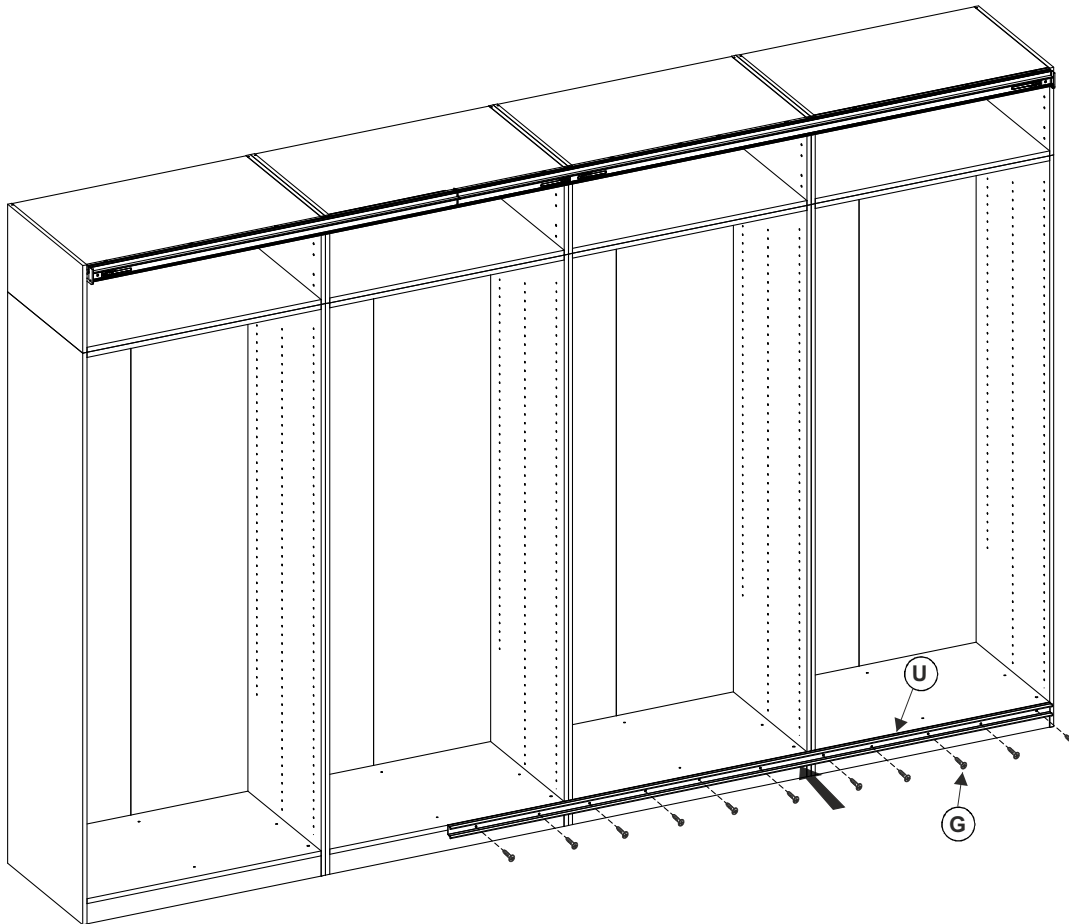
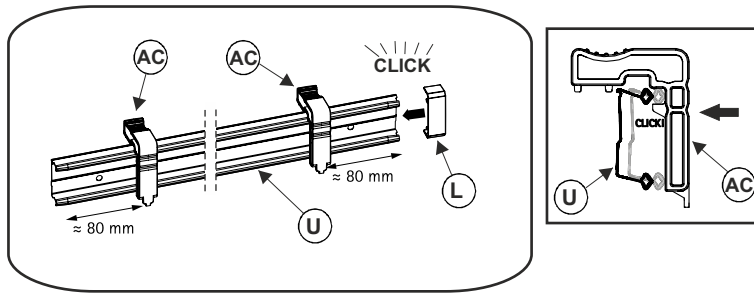
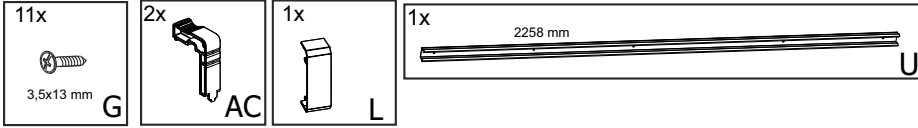

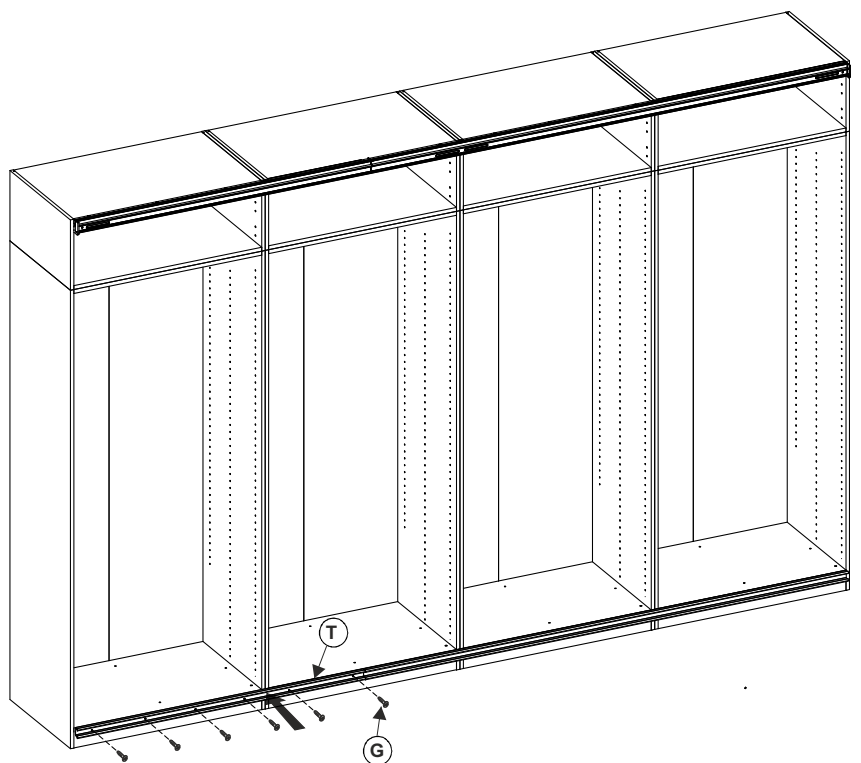
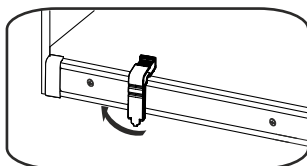
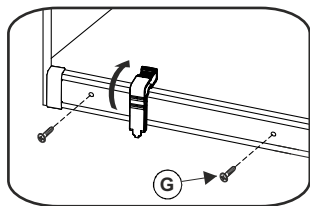
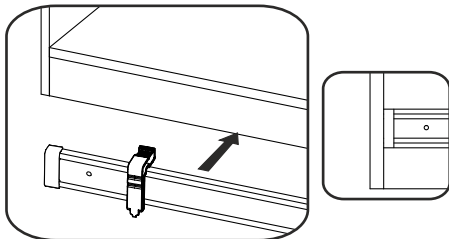
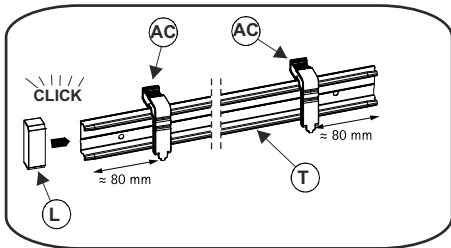
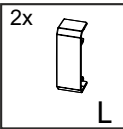
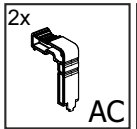
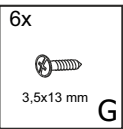
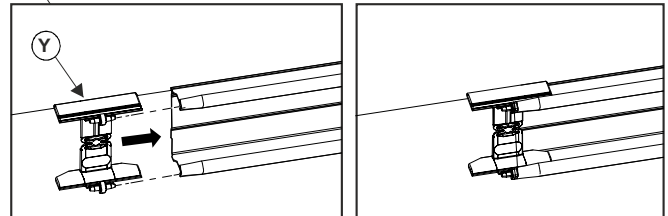
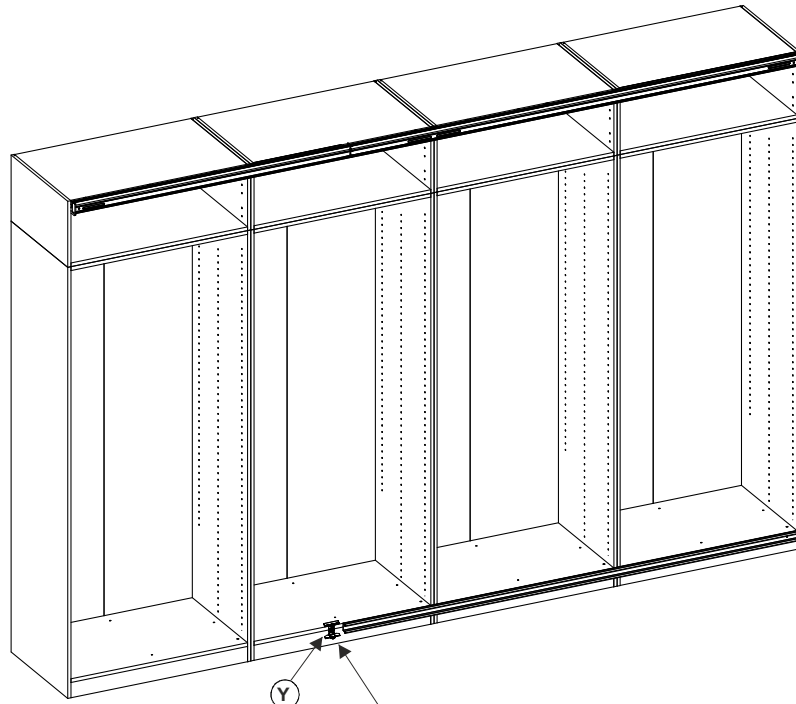
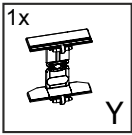

14

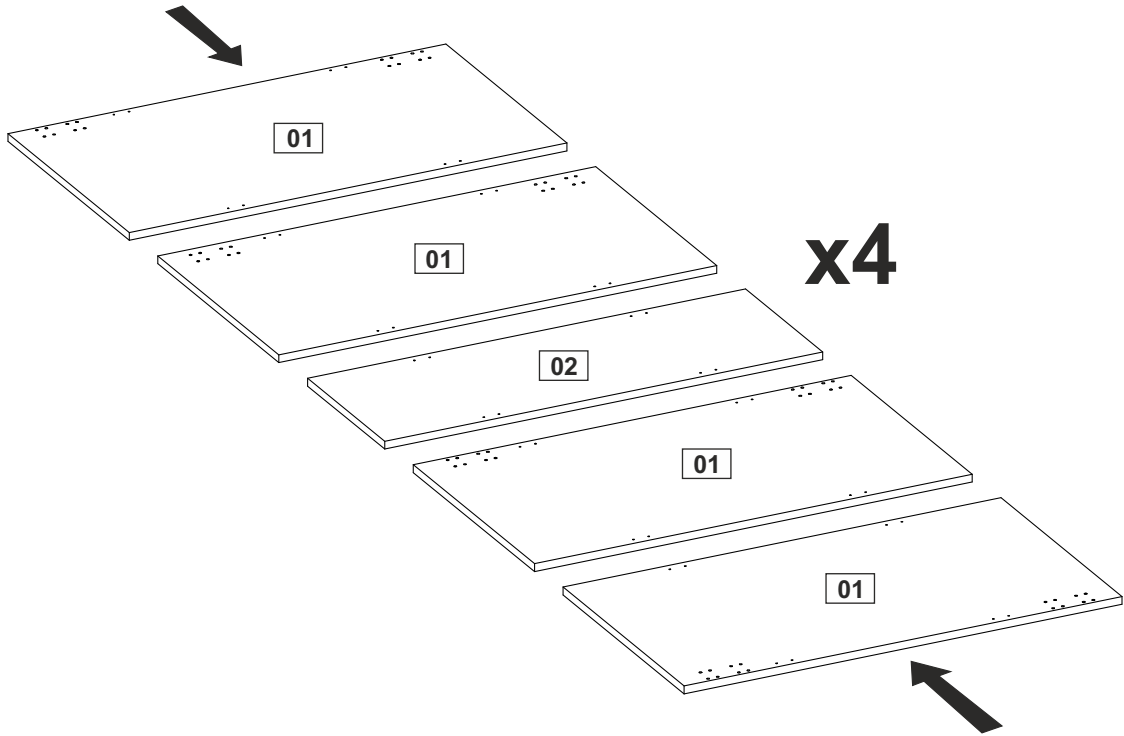
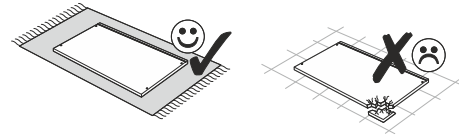

15

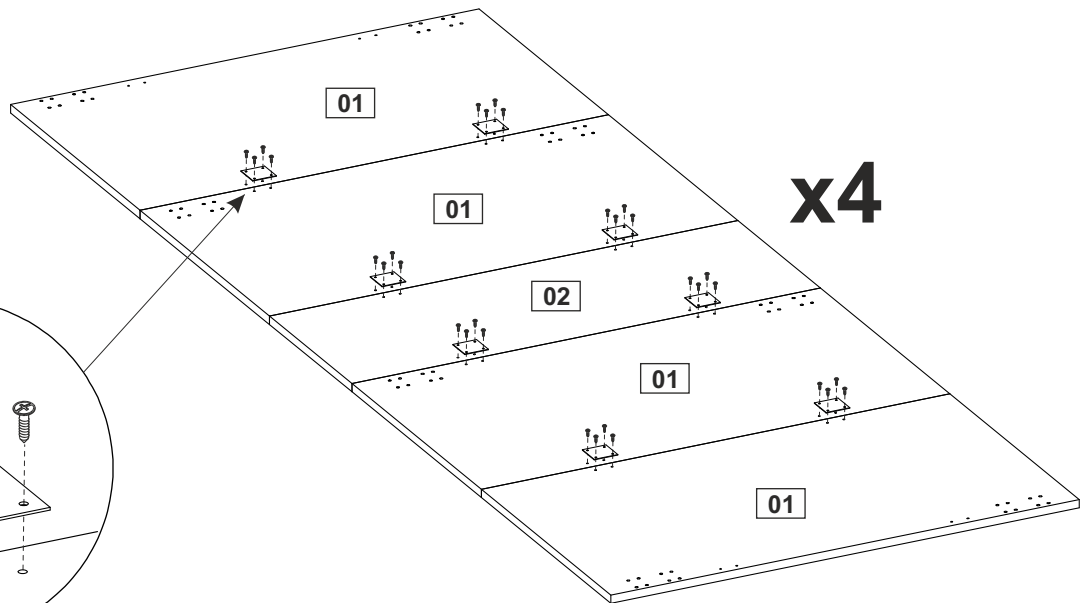
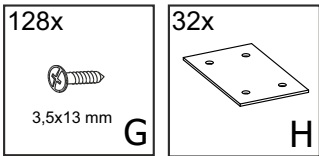
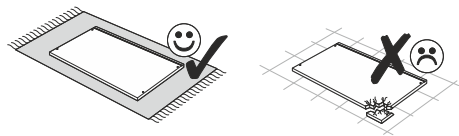

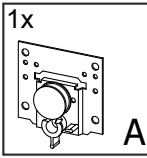
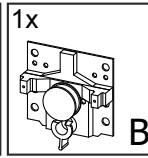
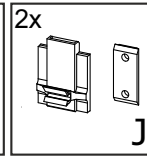
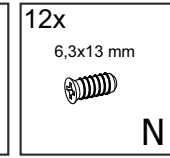

UNIT 3600/2346

16

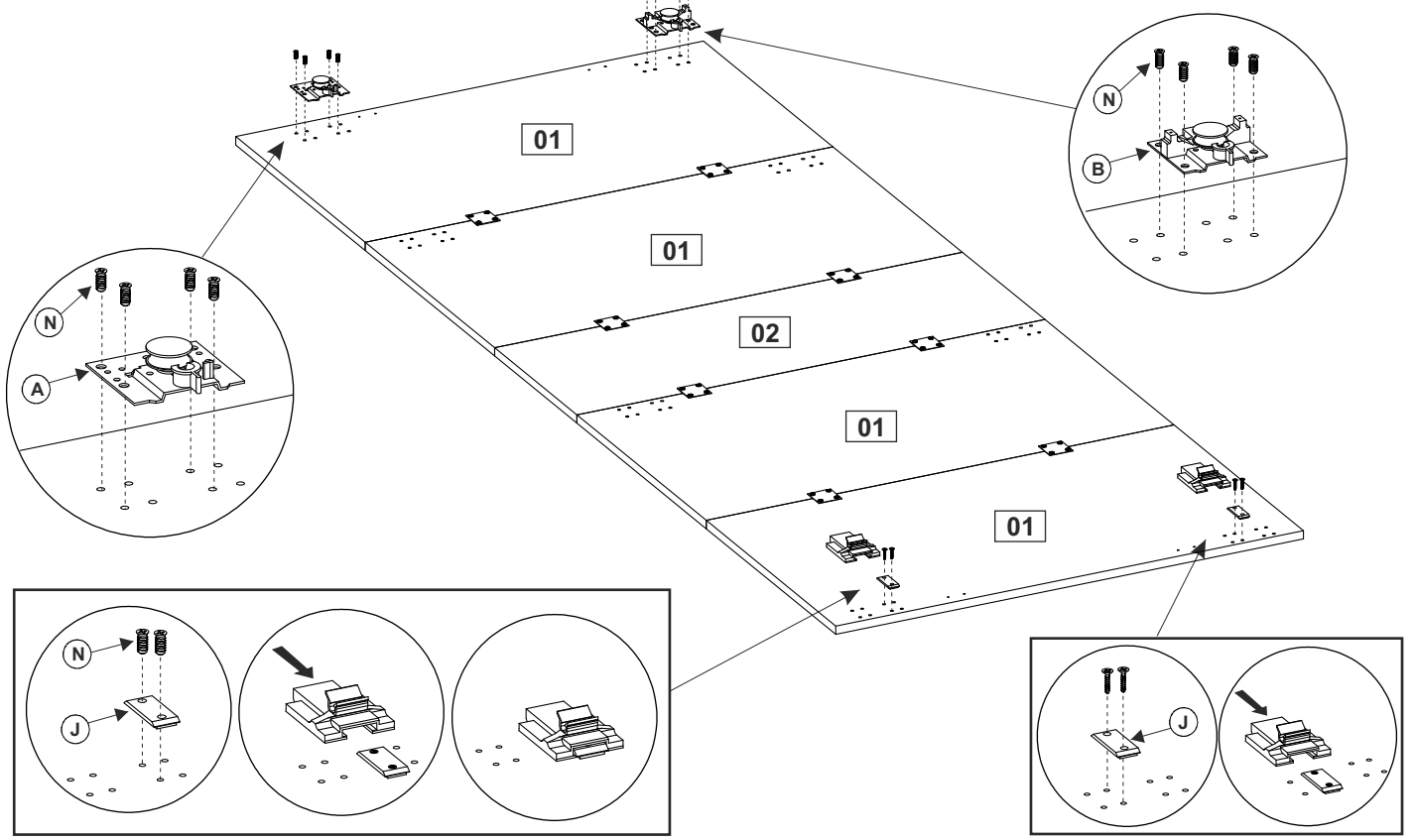
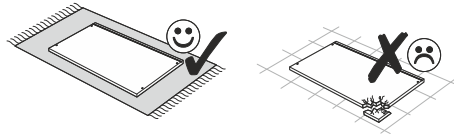
- 1x  **A**
- 1x  **B**
- 2x  **J**
- 12x  **N**
6,3x13 mm

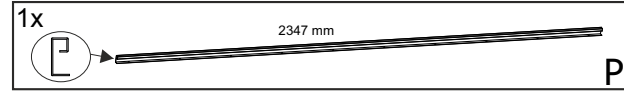

17

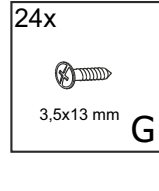
- 1x  **P**
2347 mm
- 1x  **Q**
2347 mm
- 24x  **G**
3,5x13 mm

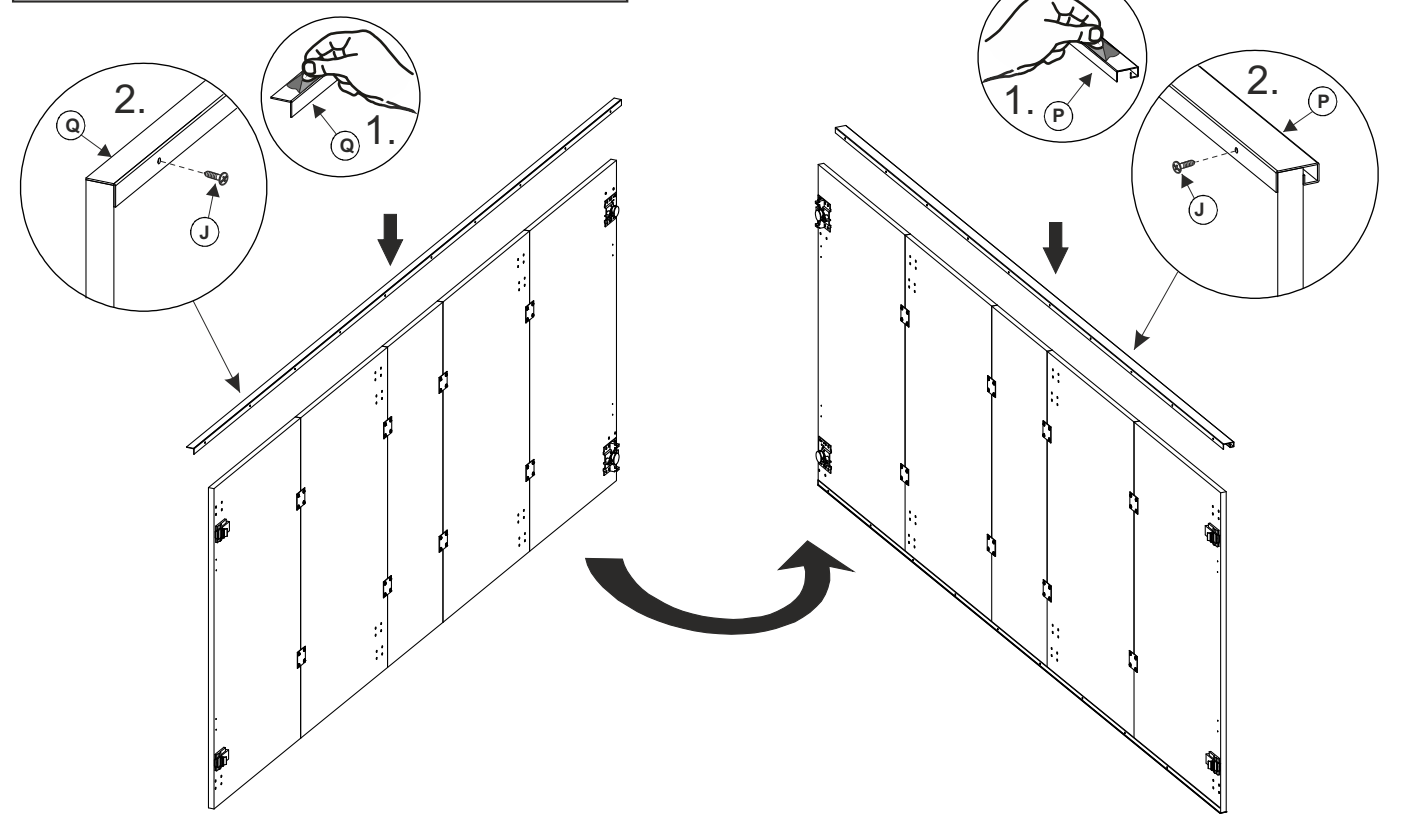
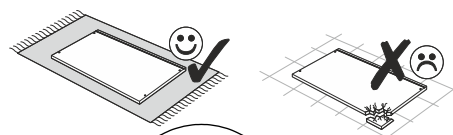

UNIT 3600/2346

18

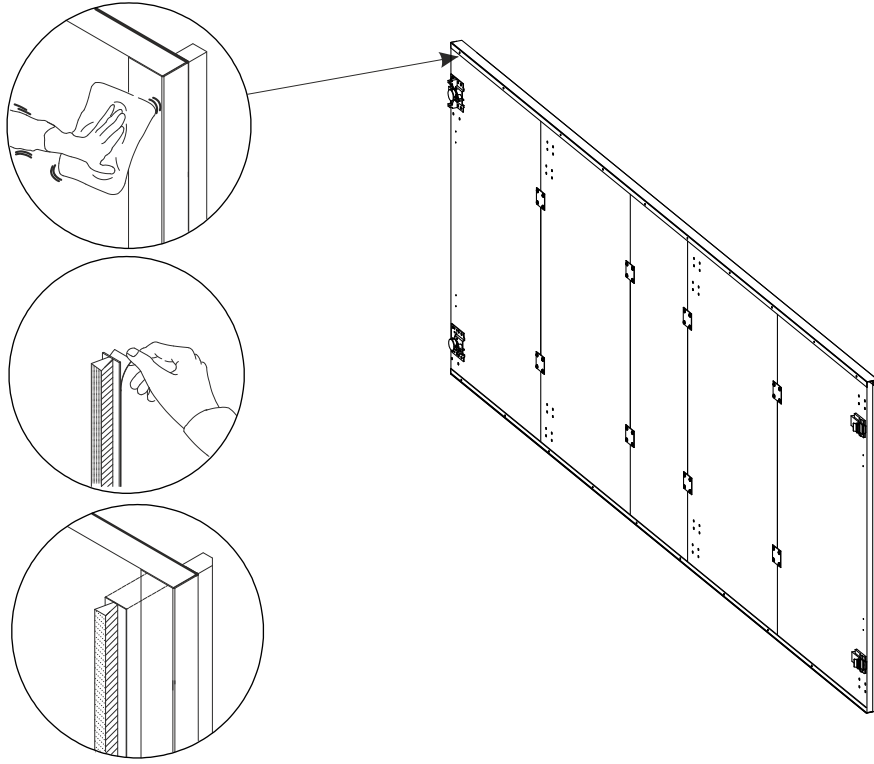
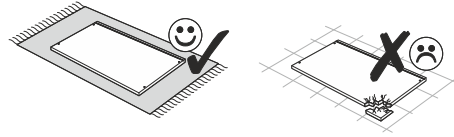
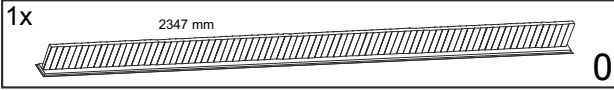

19

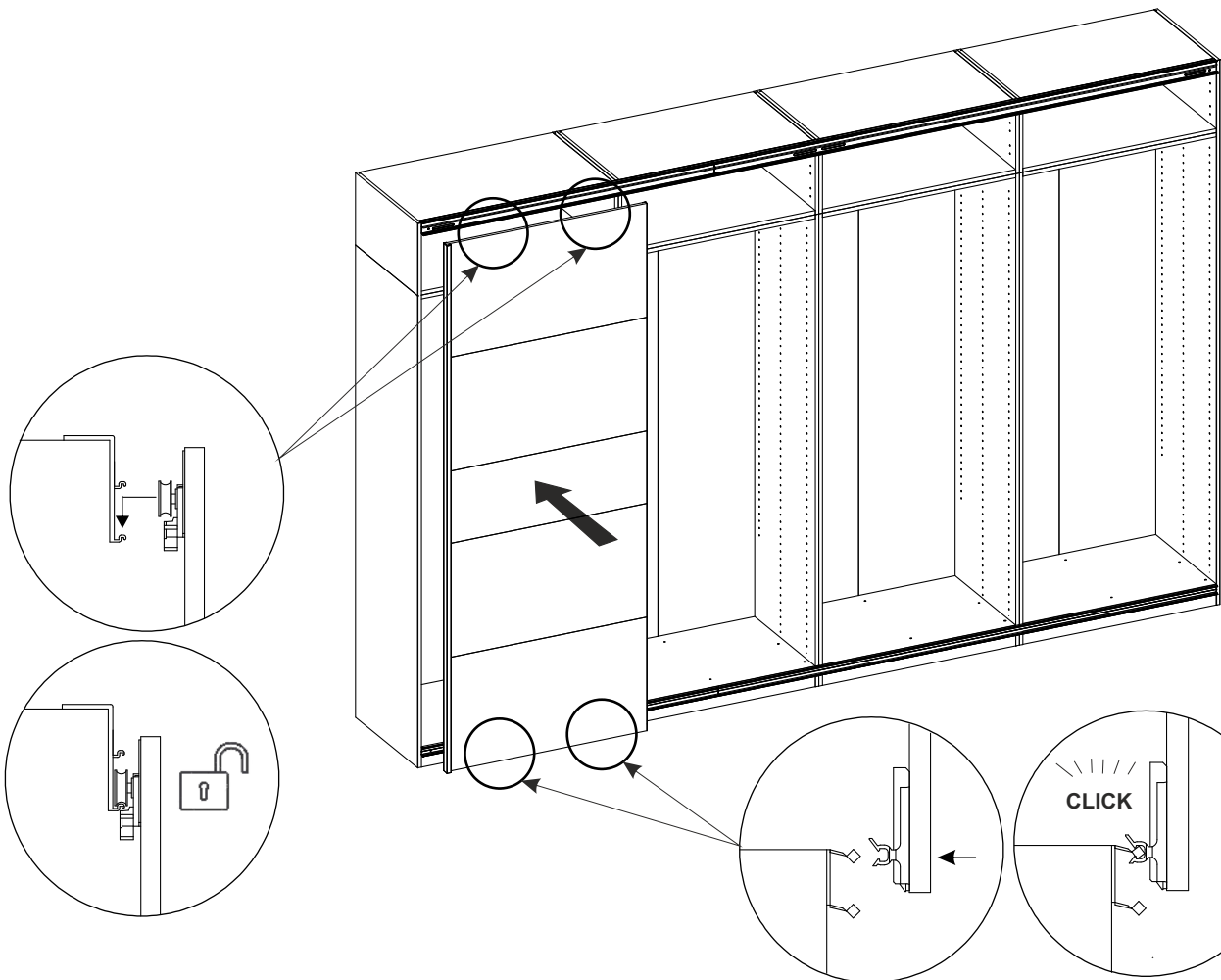

20

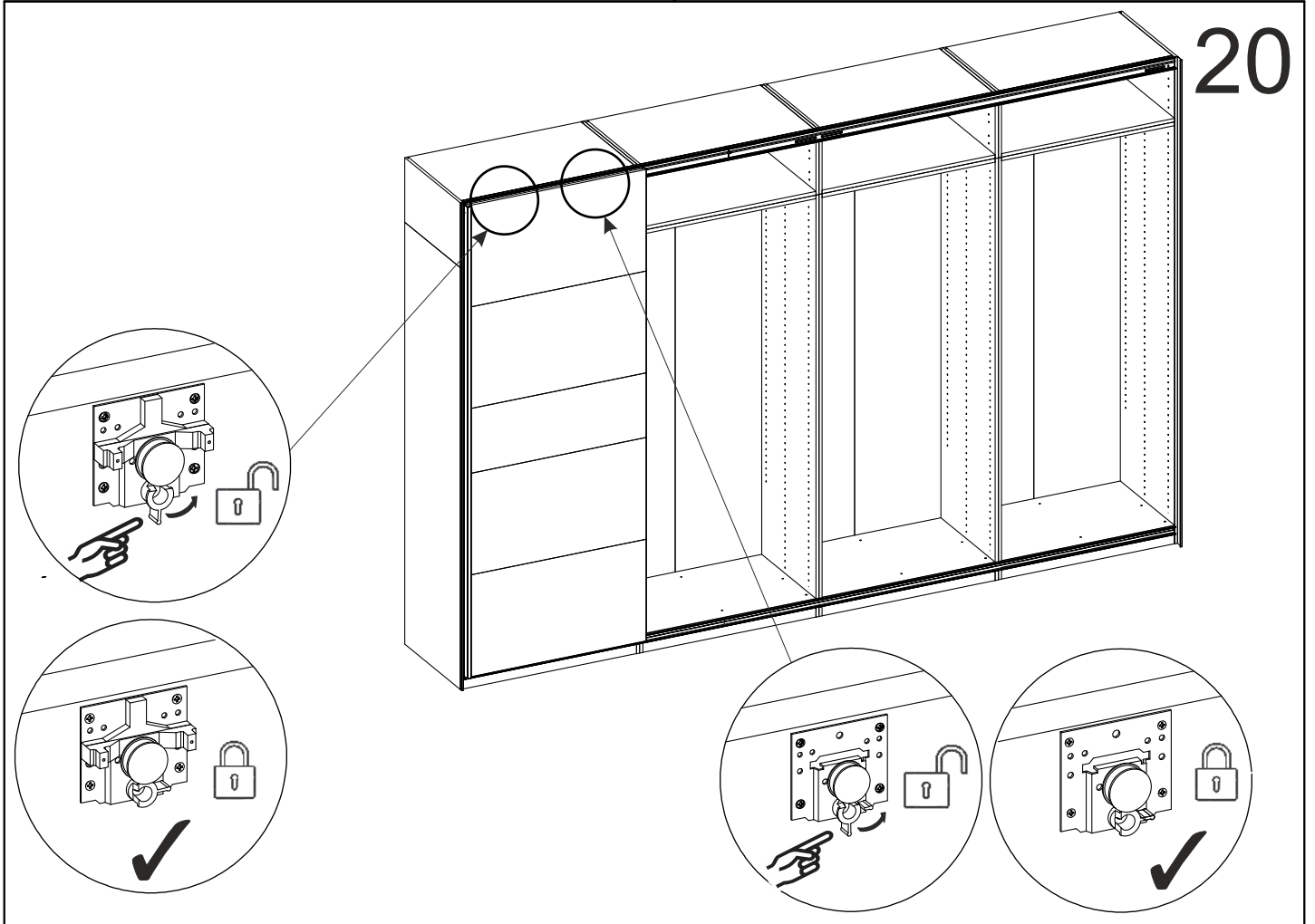

21

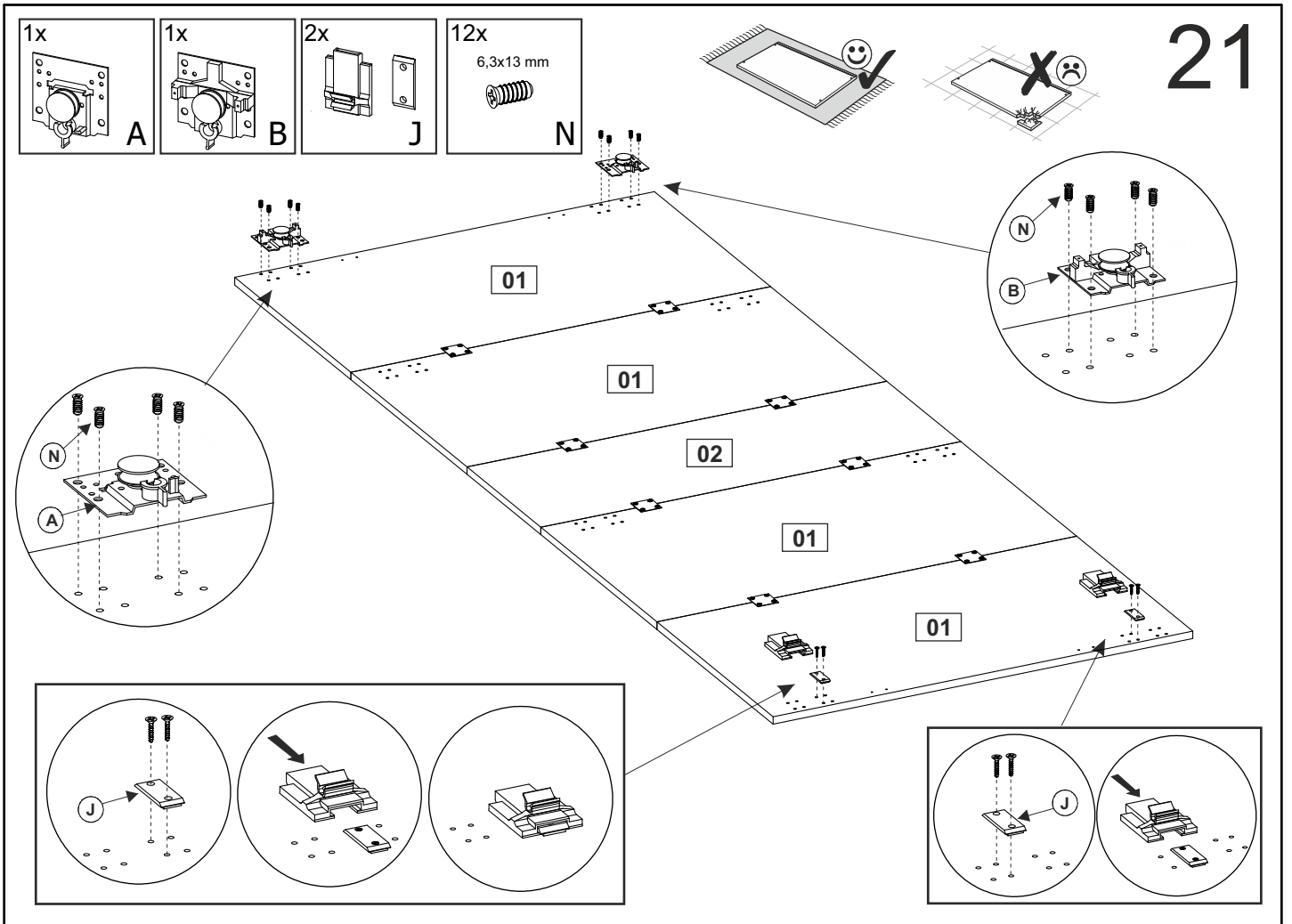

UNIT 3600/2346

22

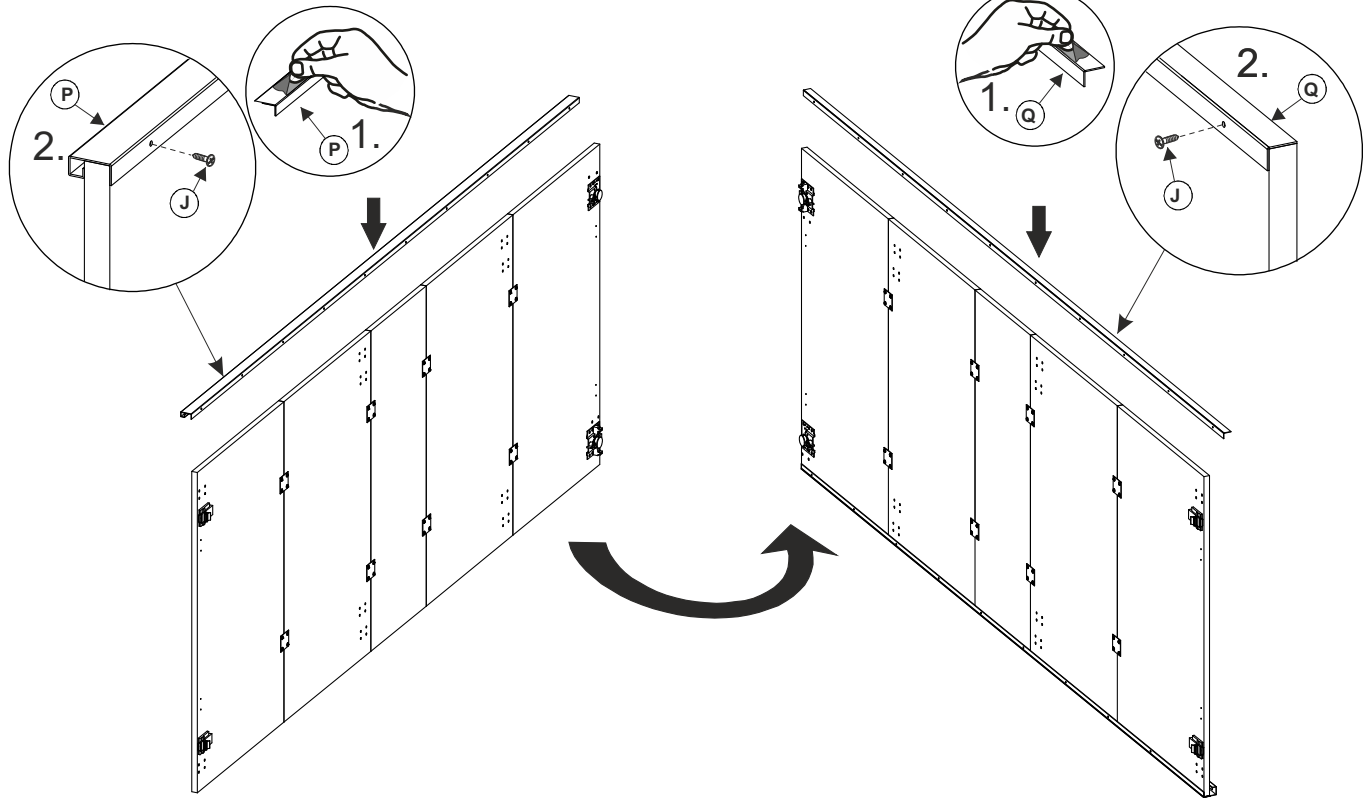
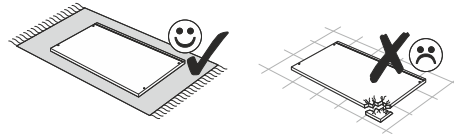
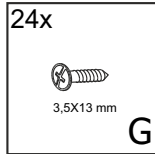
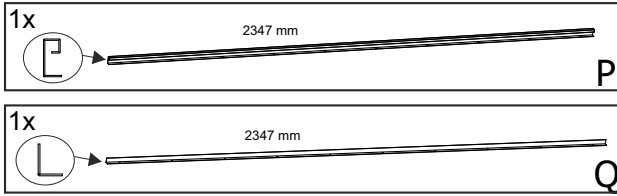

23

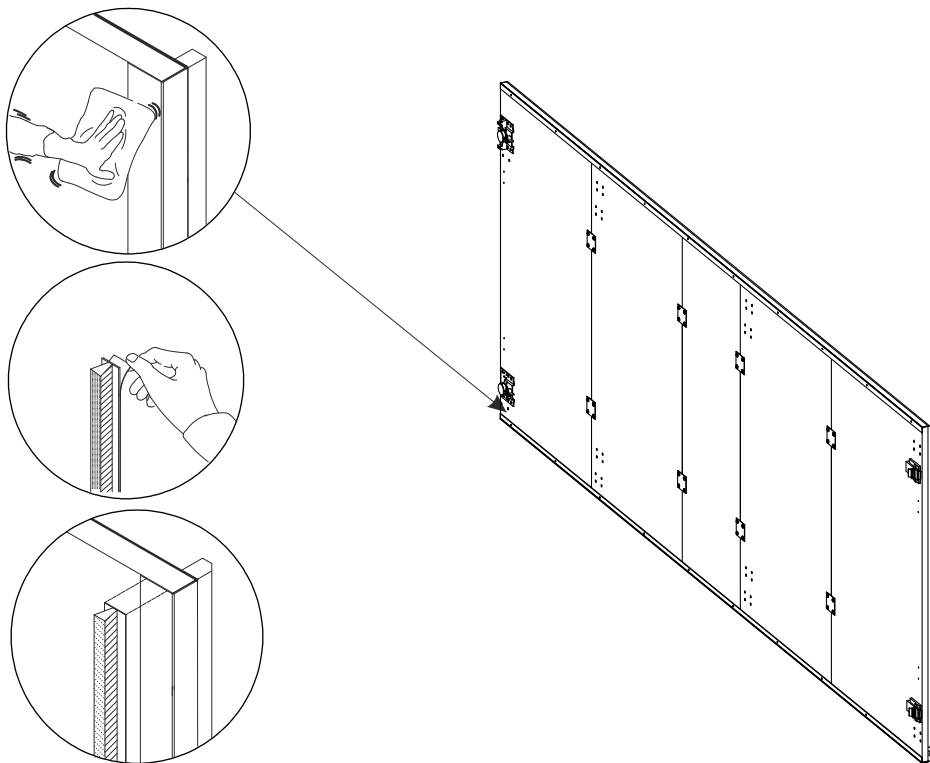
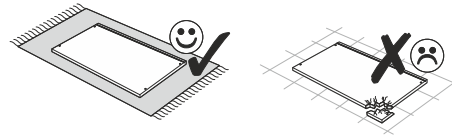
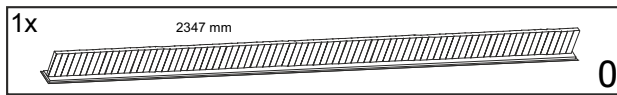

24

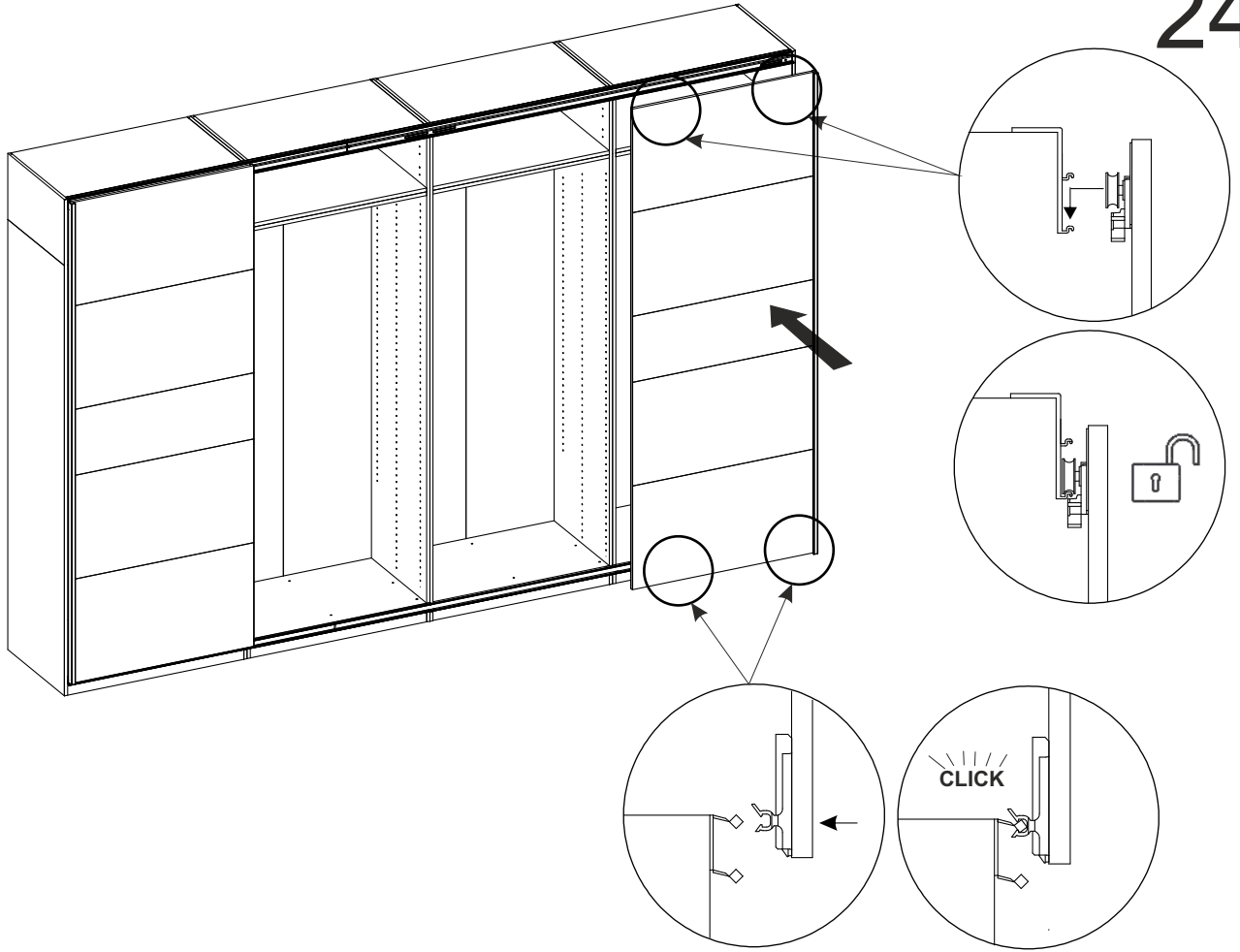

25

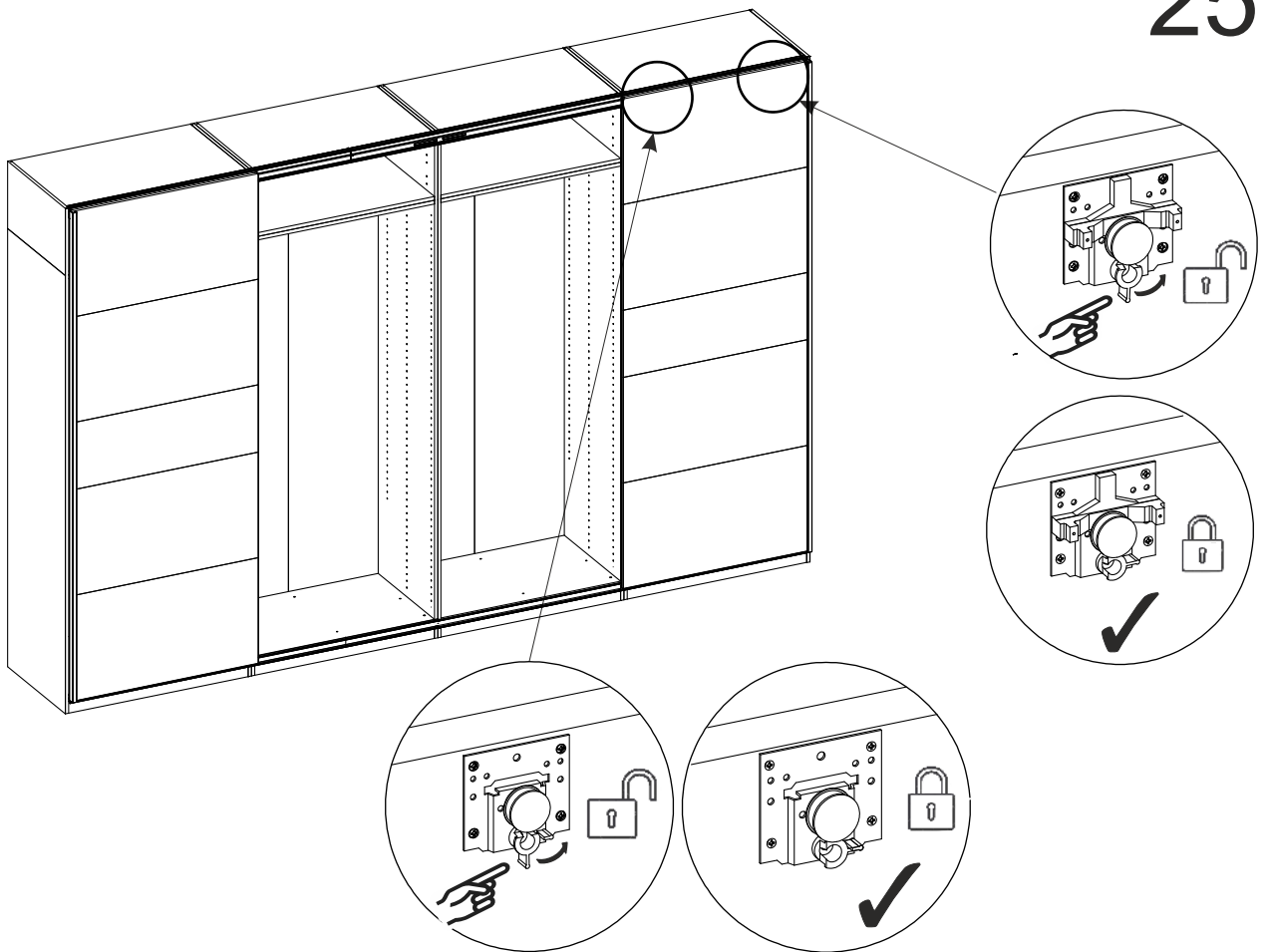

UNIT 3600/2346

26

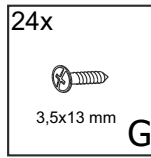
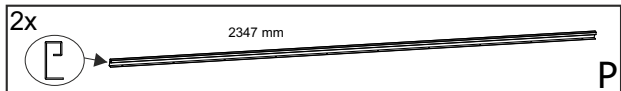
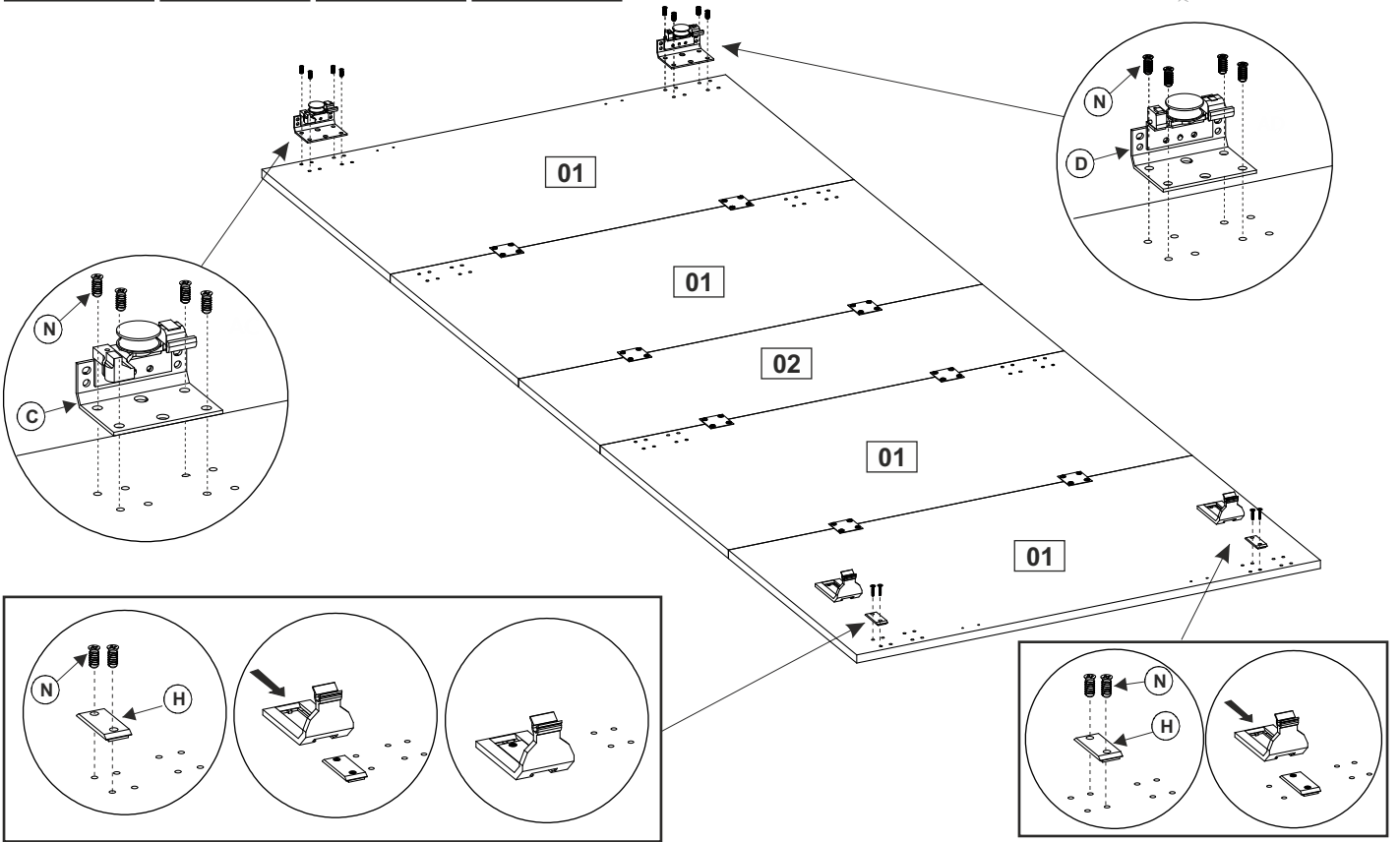
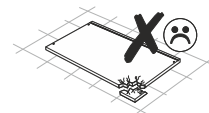
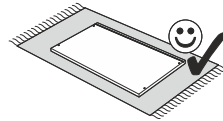
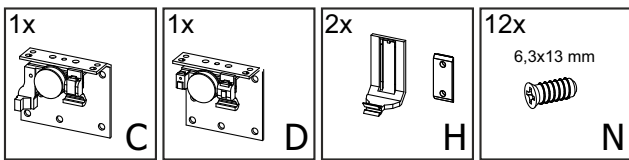

27

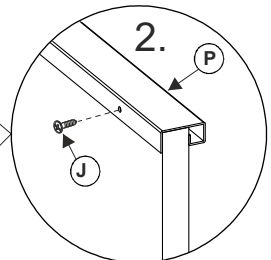
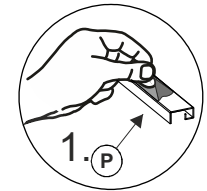
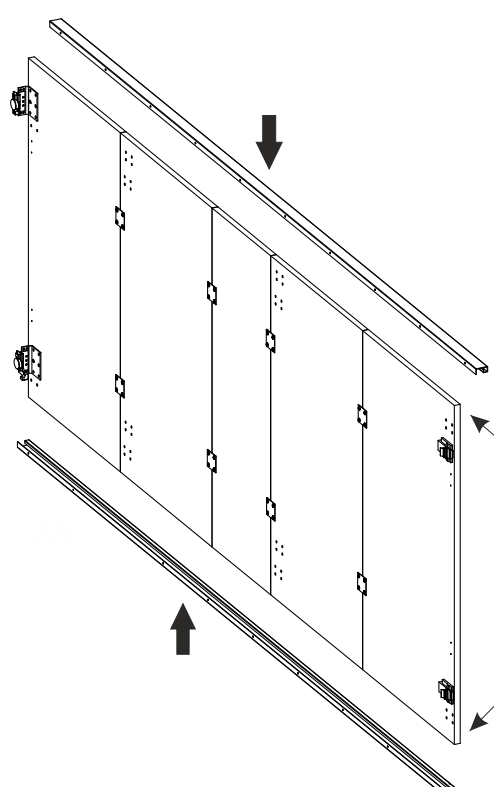
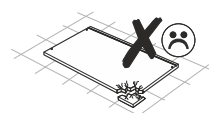
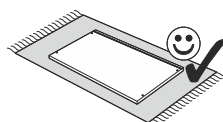

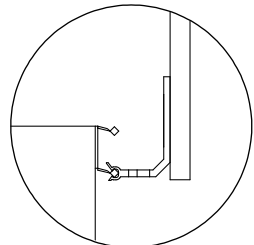
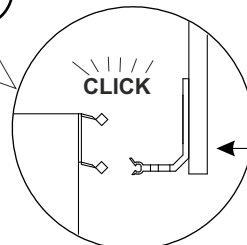
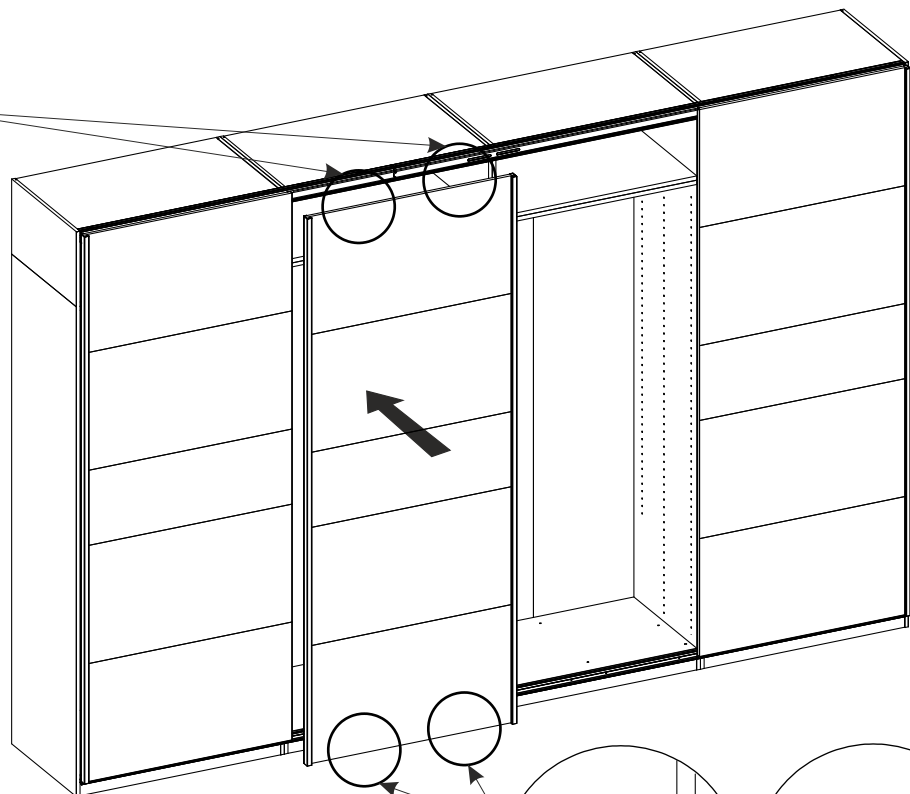
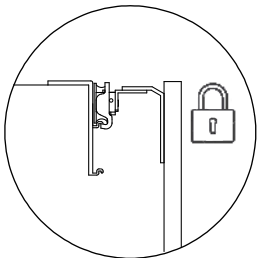
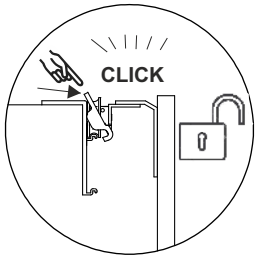
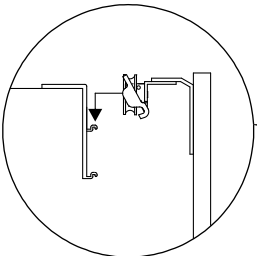
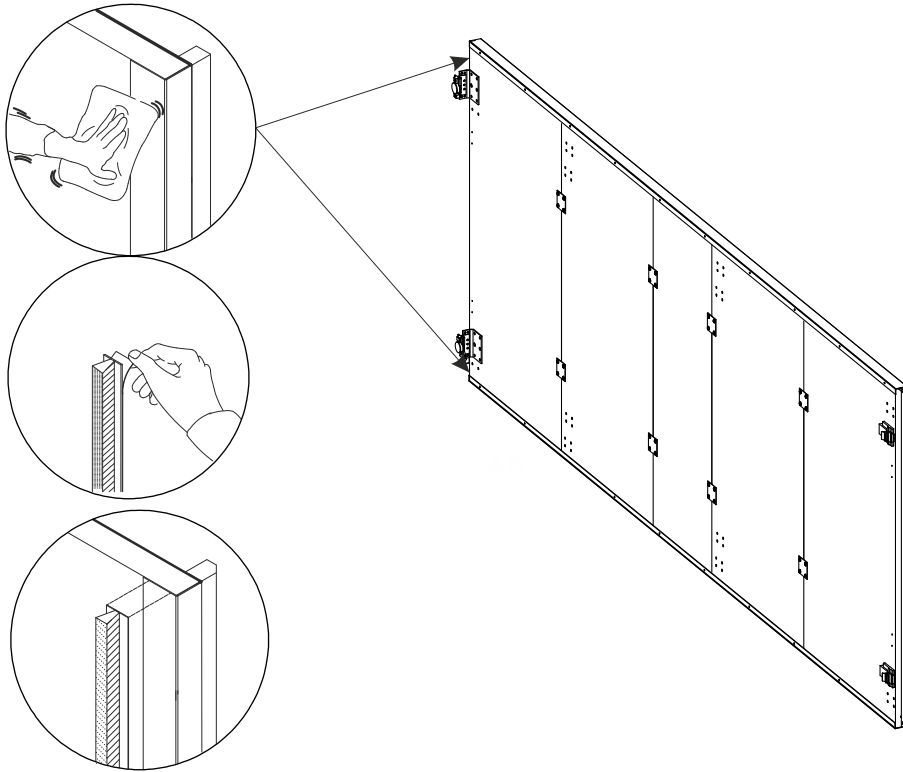
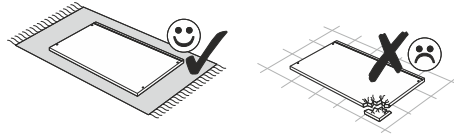
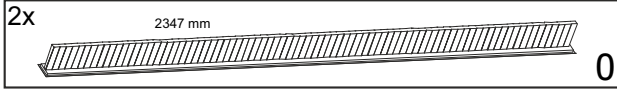

UNIT 3600/2346

30

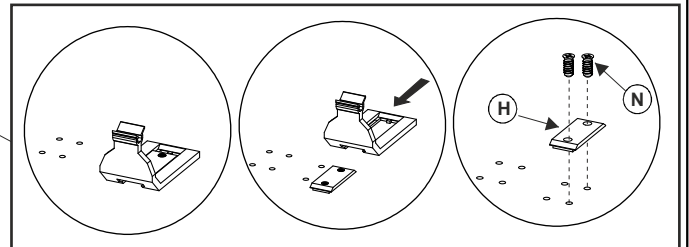
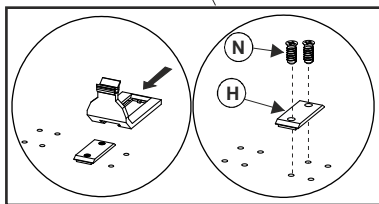
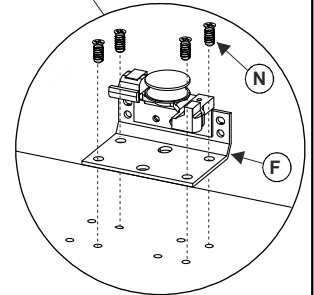
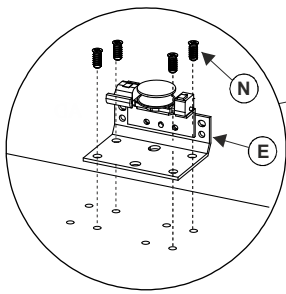
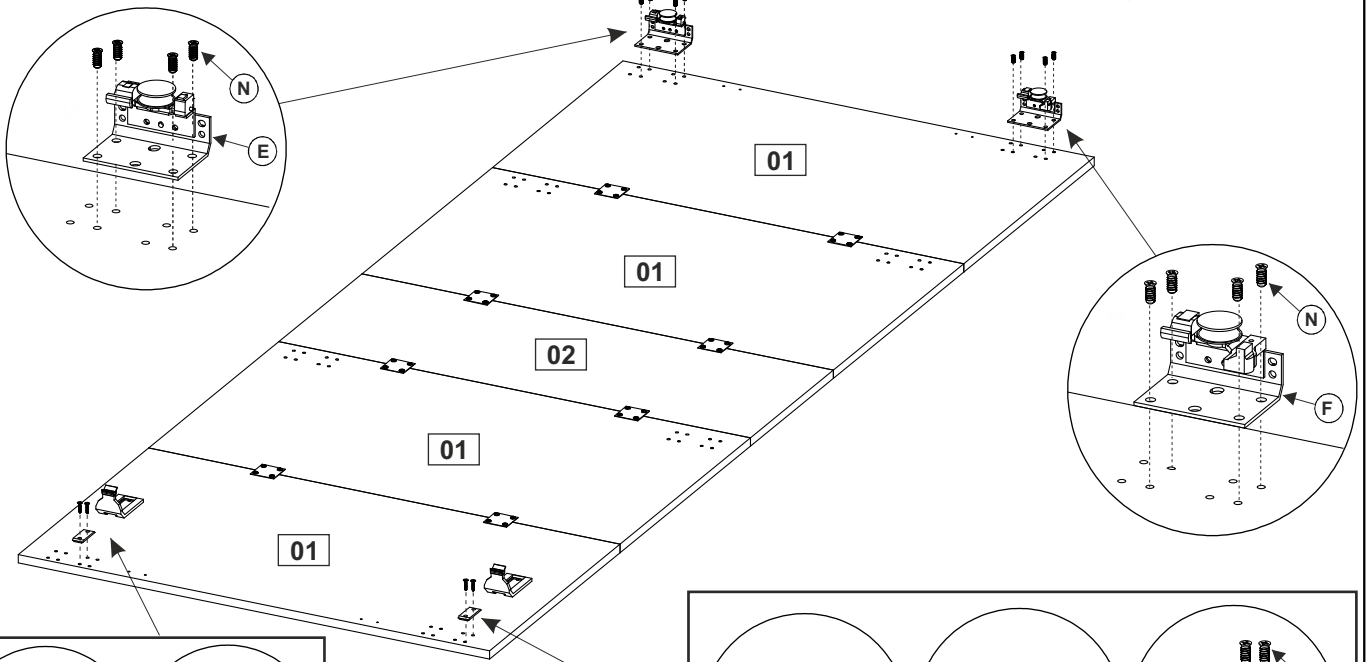
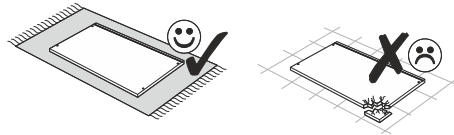
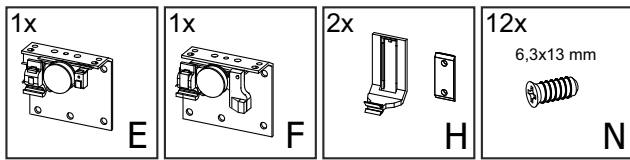

31

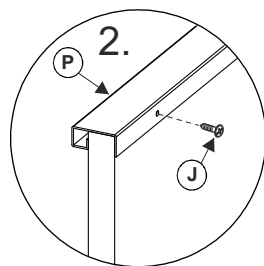
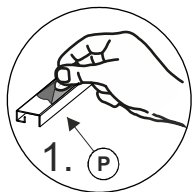
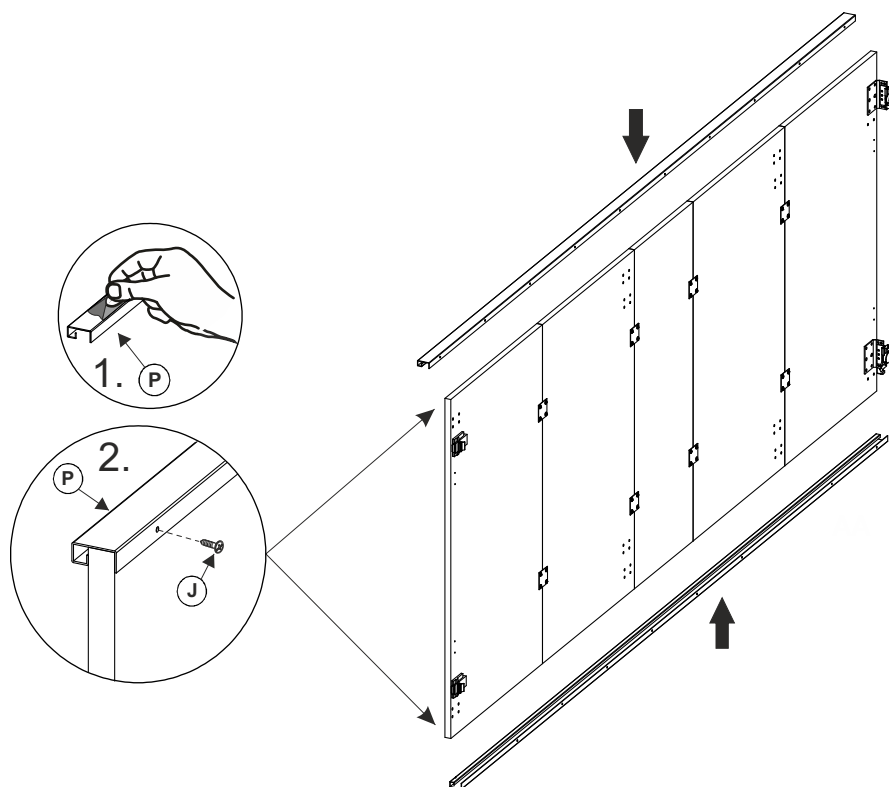
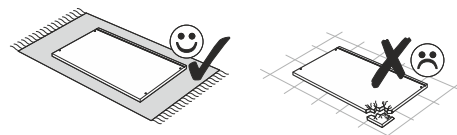
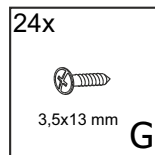
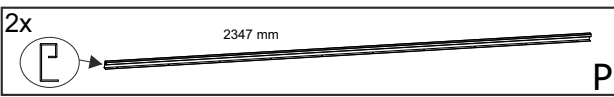

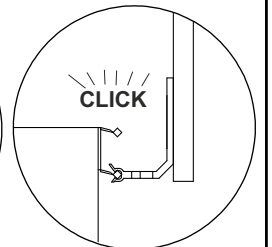
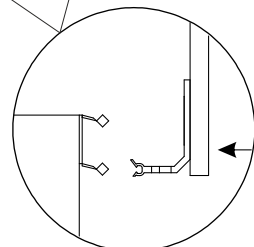
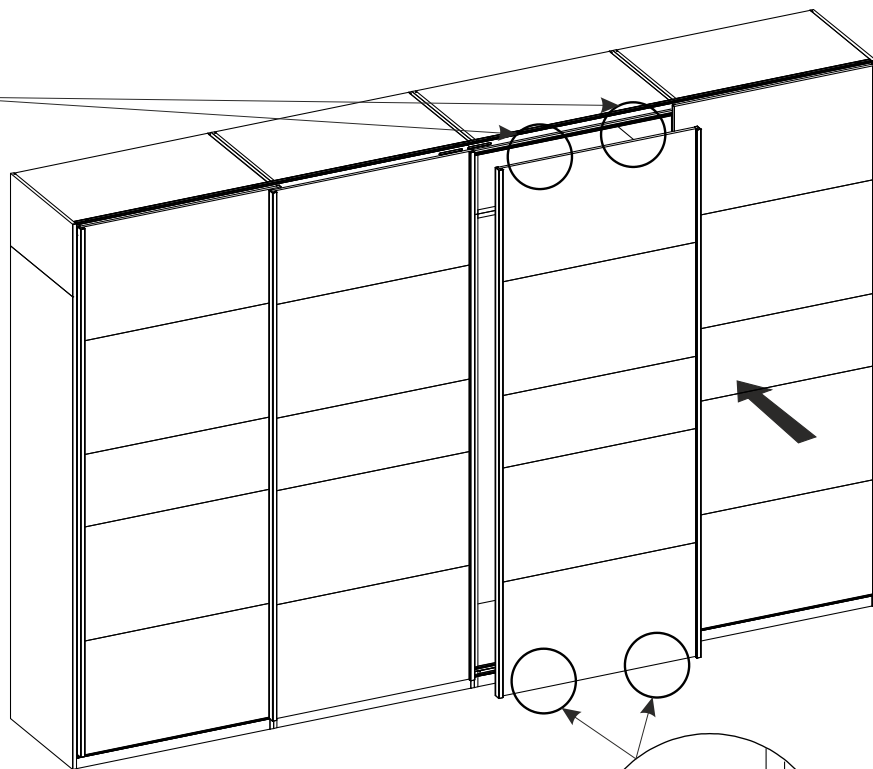
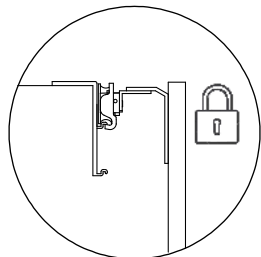
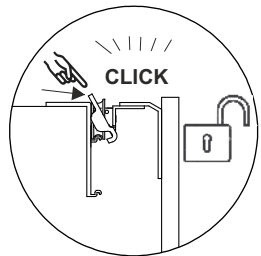
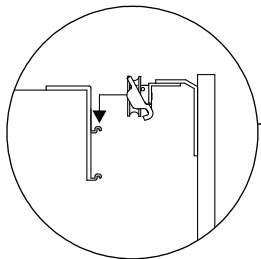
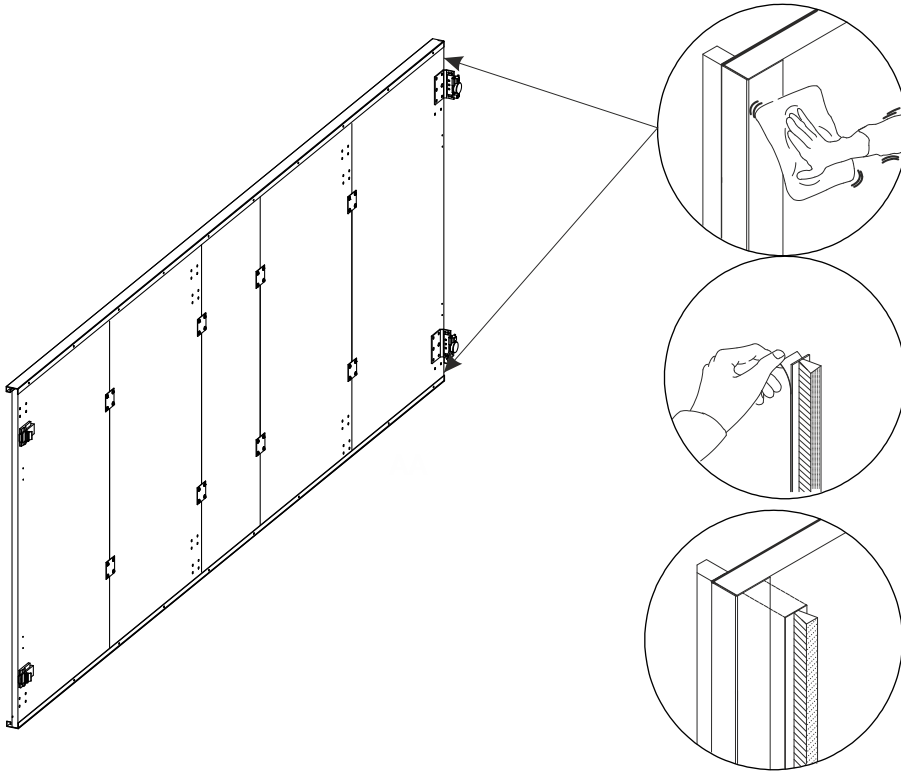
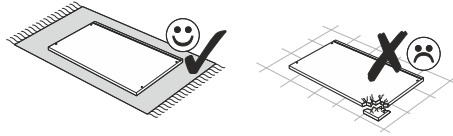
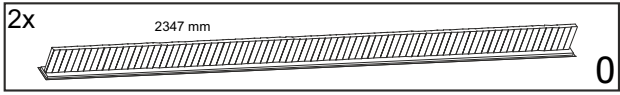

UNIT 3600/2346

34

