



MADITA 1T



# MADITA 1T

## KLEIDERSCHRANK

520x2200x610 mm

Artikel Nr.: 05320016/03

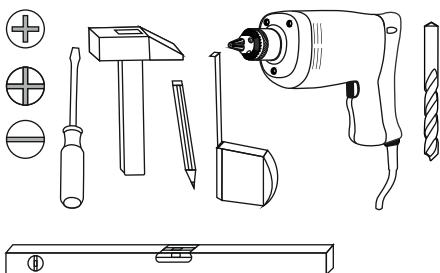
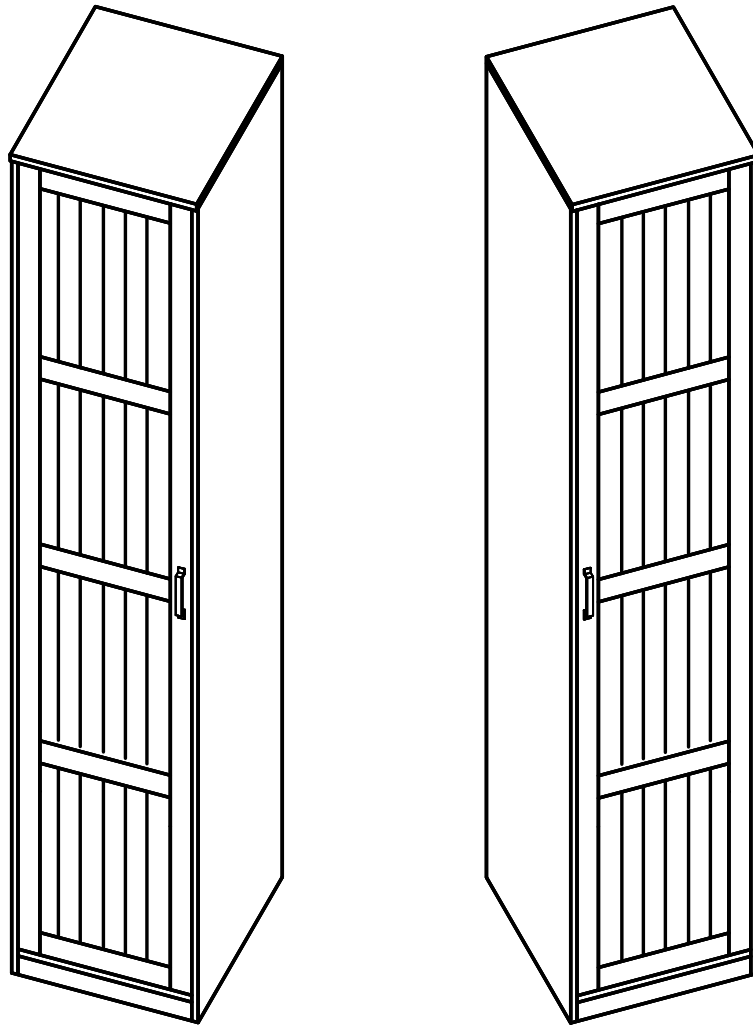

2 Pers.

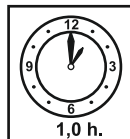

1,0 h.



festziehen/tighten/затянуть/  
serrer/stringere utáhnout/vastrekken/  
zategnuti/strangere/związac/  
szorosan meghúzni/pevne dotiahnut/  
trdno pritegniti/затянуть/dra at/



eindrücken/press in/ enfoncer/  
ribattere/zatlačit/вкaрайте/  
benyomni/stlačit/vtisniti/tryck in/  
introducere prin apasare/вдавить/



ausmessen/measure/mesures/  
misurare/opmeten/zmerat/miara/  
kimérni/izmeriti/masurare/измерить/  
změřit/измерете/mät upp/



drücken/press/presser/stisknout/  
hatnchete/vtisniti/nasinac/drukken/  
pritisnuti/nacisnac/pritisniti/нажать/  
(meg)nyomni/apasare/tryck fast/



einschlagen/hammer in/bevernii/sla in  
frapper au marteler/infossare/zabit/  
zarazit/забийте (с чук)/zabiti/  
introducere prin bataie/забить/



drehen-wenden/prosze odwrócić/  
keren-omdraaien/girare-ruotare/  
okrenuti-ubrnuti/retourner-renverser/  
turn over-turn around/otoctе-обрате/  
обърнете-завъртете/obrnite list/  
intoarceti/rotiti/vrid runt - vänd/

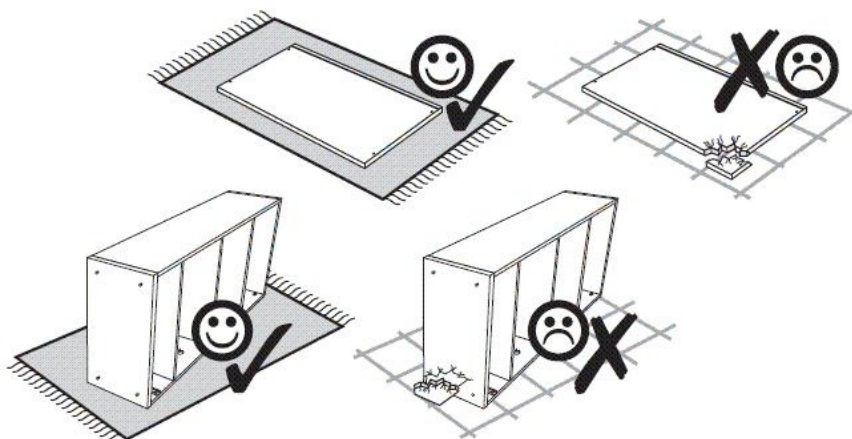
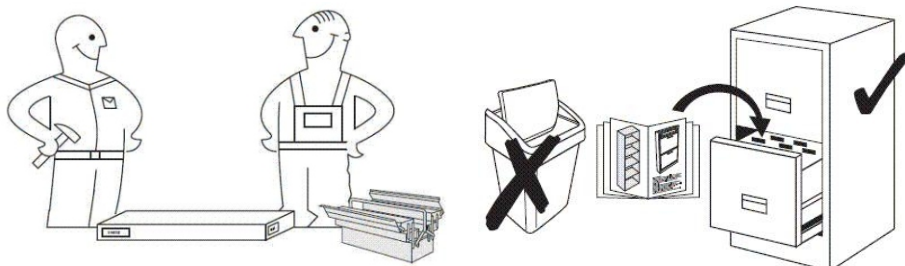

## DE

### **Achtung! Die Wandbeschaffenheit ist vor der Montage unbedingt zu prüfen.**

Die beigelegten Universaldübel sind ausschließlich nur zur Verwendung für festes Mauerwerk wie Beton/Ziegel. Die Mauerdübel dürfen nicht bei Mauerwerk wie Hohlraumziegel, Leichtbausteinen, Gipskartonplatte oder anderer Rahmenbauweise verwendet werden.

Bei diesen Mauerwerken sind gegebenenfalls Spezialdübel zu verwenden! Diese sind in einem Fachgeschäft (Baumarkt) erhältlich.

**Bei Nichteinhaltung wird seitens Produzenten/Händler und Importeur keine Haftung übernommen.**

**Kein Scheuermittel zur Reinigung verwenden !**

## CZ

### **Upozornění! Před montáží je nutné zkontrolovat stav stěny.**

Příložené univerzální hmoždinky jsou určeny pouze k použití pro pevné zdivo jako beton/cihly.

Hmoždinky do zdi se nesmí používat u dutinová cihla, zdiva jako pórovitý stavební kámen, sádkartónová deska nebo jiný měkký materiál.

U těchto zdív jsou nutné použít speciální hmoždinky! Jsou k dostání v speciálních prodejnách se stavebním materiálem.

**Při nedodržení těchto pokynů výrobce/prodejce a dovozce neručí za způsobené škody.**

**Při čištění nepoužívejte abrazivní čisticí prostředky !**

## SLO

### **Pozor! Pred montažo preverite stanje stene.**

Priloženi univerzalni mozniki so izključno samo za uporabo na čvrstem zidovju, kot sta beton in opeka.

Stenski mozniki se ne smejo uporabljati pri zidovju kot so votlino opeke, zidaki za lahko gradnjo, mavčne plošče ali druge okvirne gradnje.

Pri teh zidovjih morate v danih primerih uporabljati posebne moznike. Ti so na voljo v specializiranih trgovinah (trgovinah z gradbenim materialom)

**Pri upoštevanju se s strani proizvajalca/trgovca in uvoznika ne prevzame jamstvo.**

**Ne čistite sredstvi za ribanje !**

## HU

### **Vigyázat! Szerelés előtt a falfelületet feltétlenül vizsgálja meg.**



A mellékelt univerzális tipli kizárólag stabil falazathoz használható mint például beton/tégla.

A fali tipli nem használható könnyű építőkövek hez, üreg tégla, gipszkarton lapokhoz vagy más favázás építményekhez. Ezekhez a falfelületekhez csak speciális tiplik használhatóak, melyek szaküzletekben (barkácsáruházakban) beszerezhetőek.



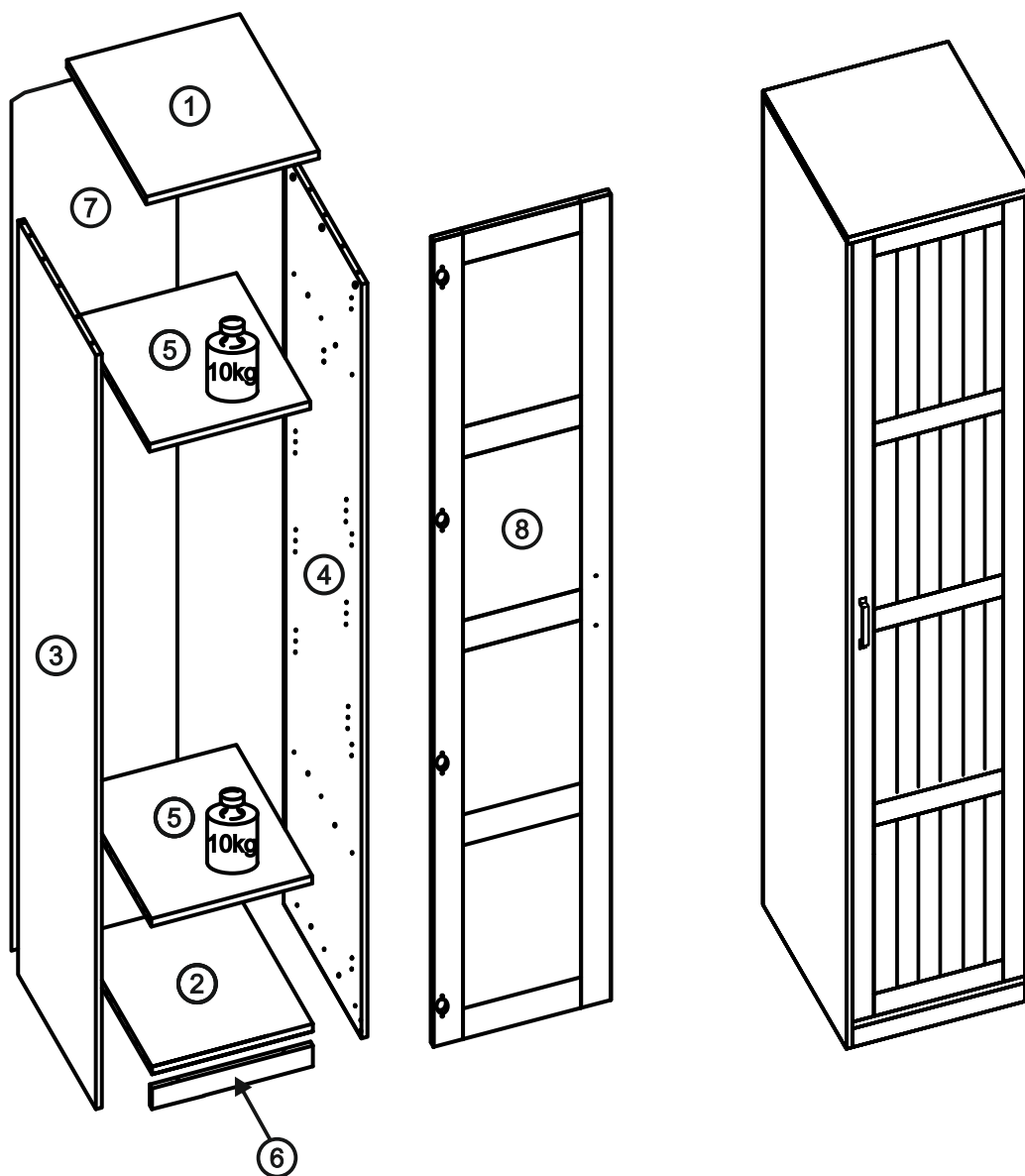

**Fentiek figyelmen kívül hagyása esetén a gyártó/kereskedő vagy forgalmazó nem vállal felelősséget.**

**Ne használjon dörzshatású súrolószert !**

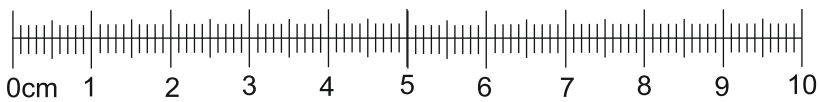
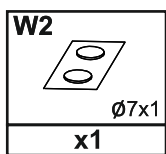
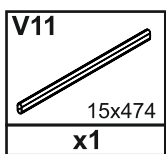
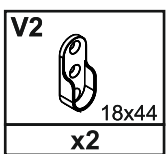
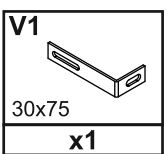
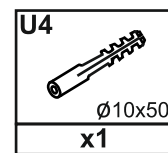
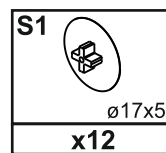
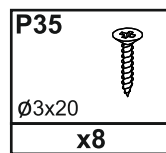
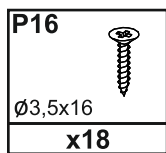
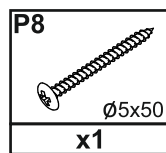
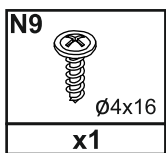
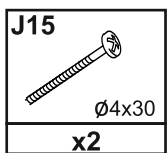
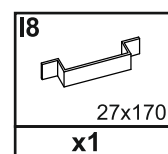
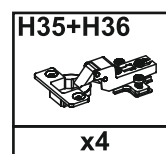
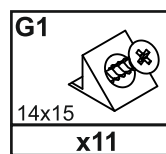
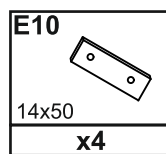
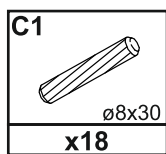
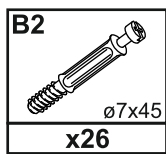
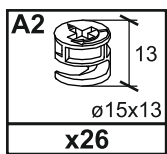
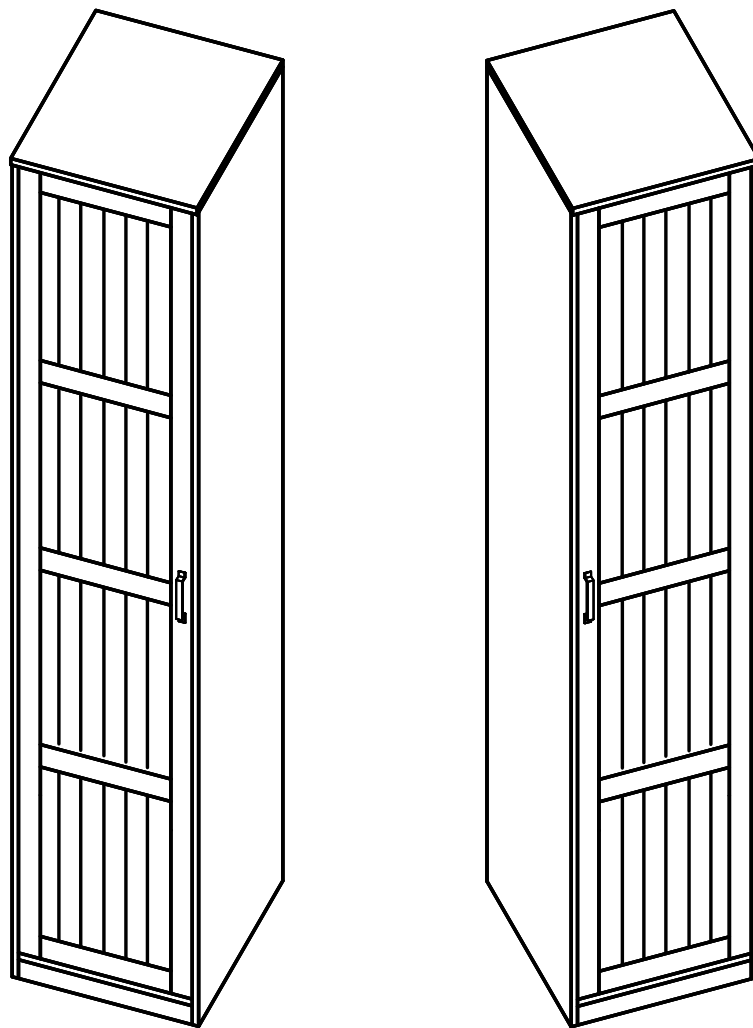

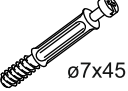
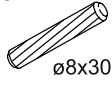
Nr.				
	A	B ( mm )		
1	610	520	18	1x 1/2
2	584	482	18	1x 1/2
3	2182	600	18	1x 1/2
4	2182	600	18	1x 2/2
5	558	482	18	2x 1/2
6	482	60	18	1x 2/2
7	2131	500	3	1x 2/2
8	2098	476	22	1x 2/2



<b>1</b>	<b>A2</b>  ø15x13 <b>x6</b>	<b>B2</b>  ø7x45 <b>x20</b>	<b>C1</b>  ø8x30 <b>x4</b>	<b>E10</b>  14x50 <b>x4</b>	<b>P16</b>  ø3,5x16 <b>x4</b>	<b>P35</b>  ø3x20 <b>x8</b>	<b>V2</b>  18x44 <b>x2</b>
----------	---	---	--	---	---	---	--

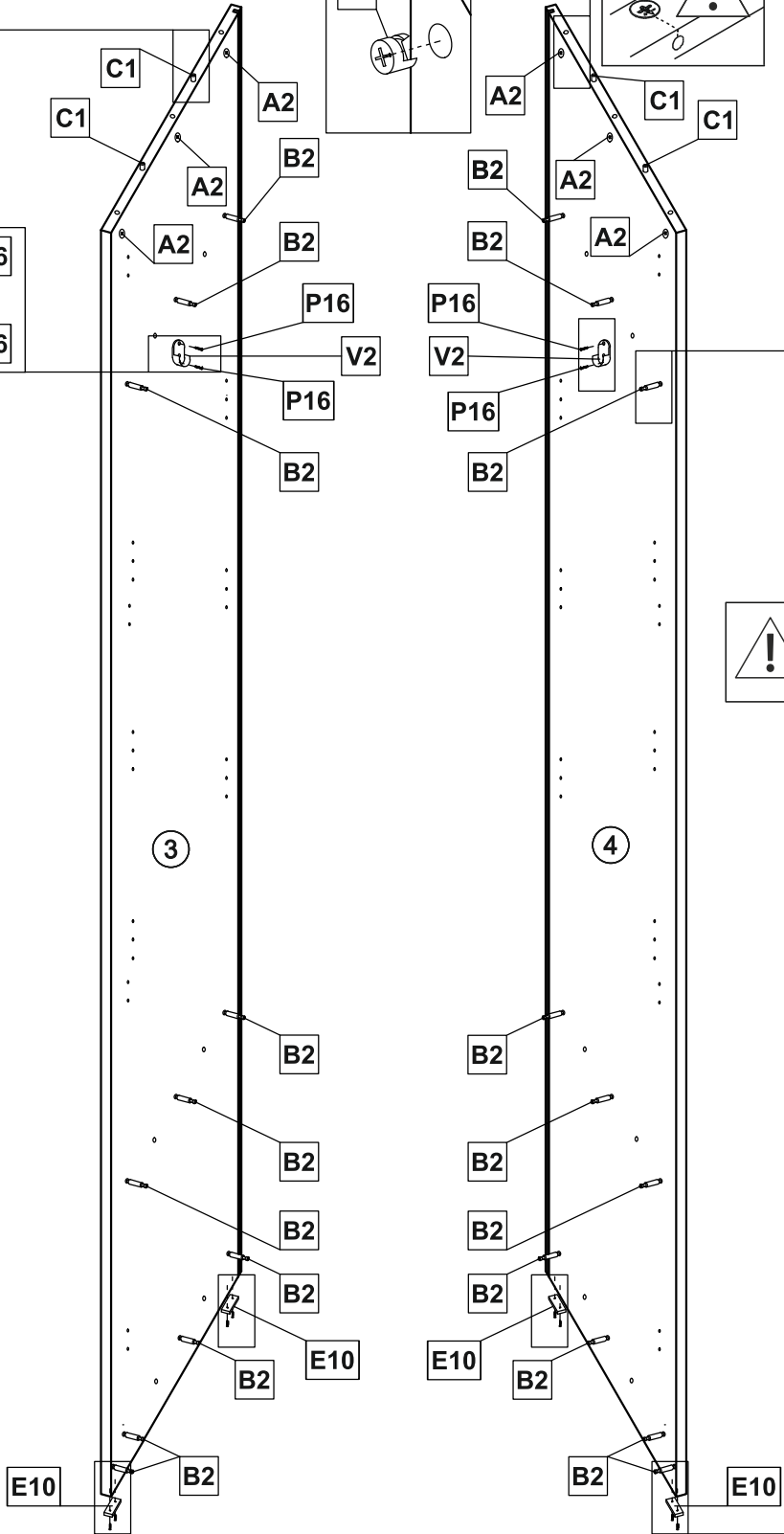
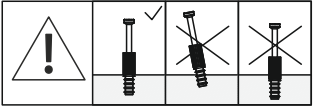
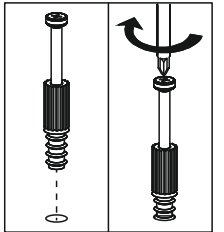
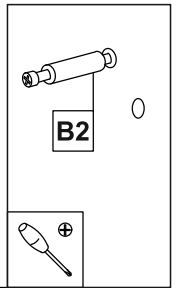
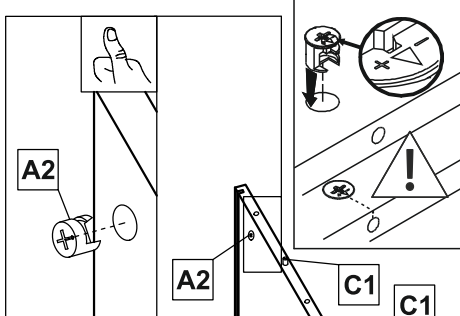
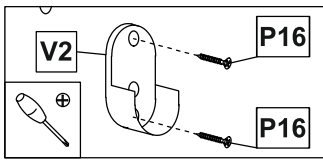
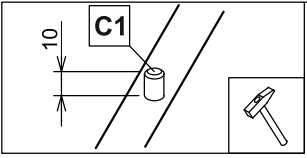
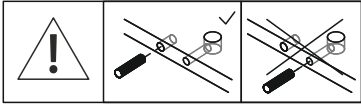

**4x**

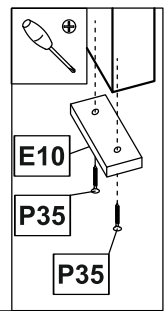

# 2

<b>A2</b>  ø15x13 x12	<b>B2</b>  ø7x45 x6	<b>C1</b>  ø8x30 x8
--------------------------------	------------------------------	------------------------------

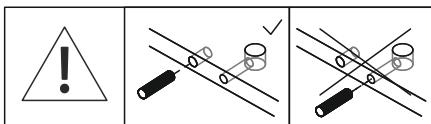
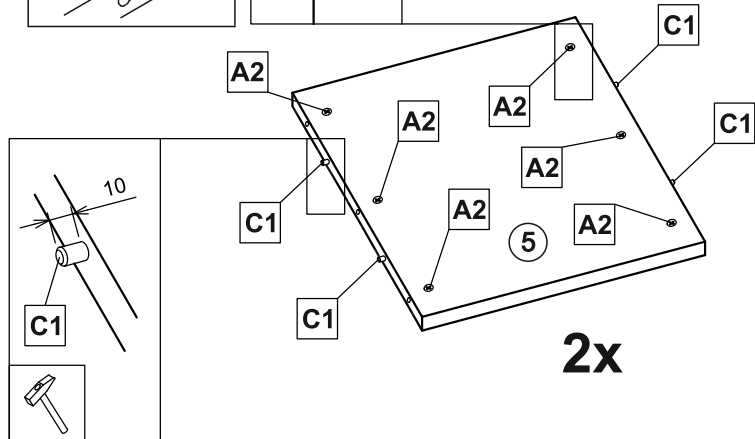
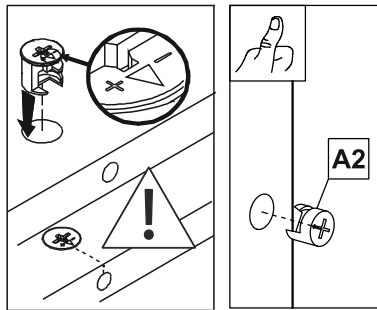
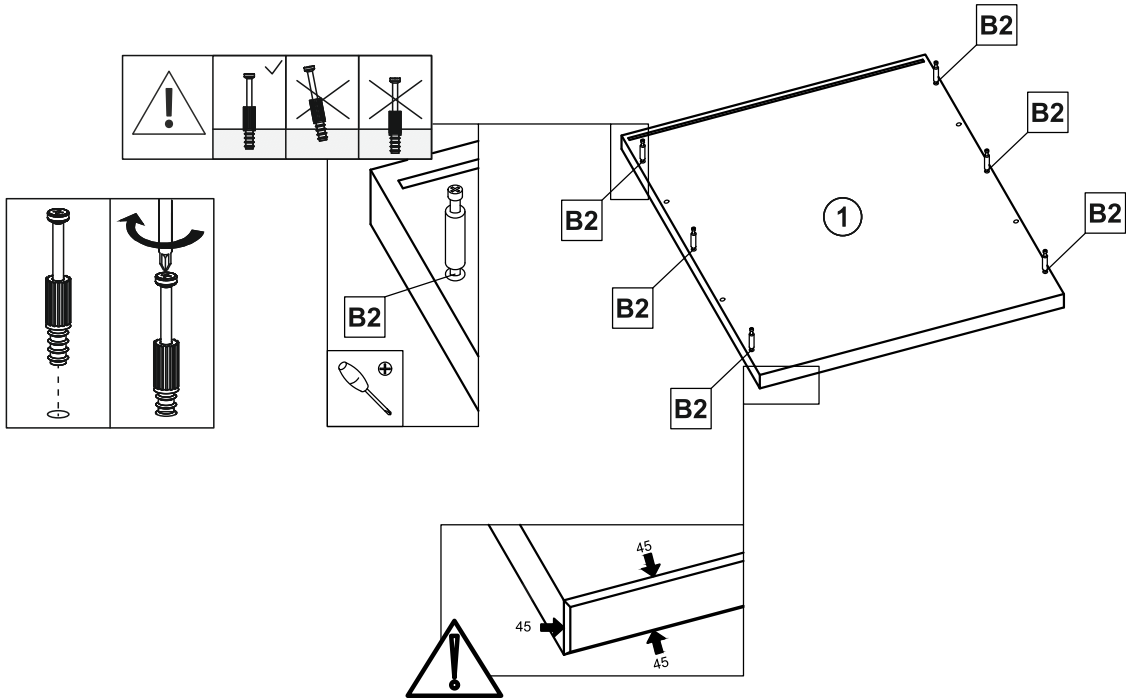



# 3

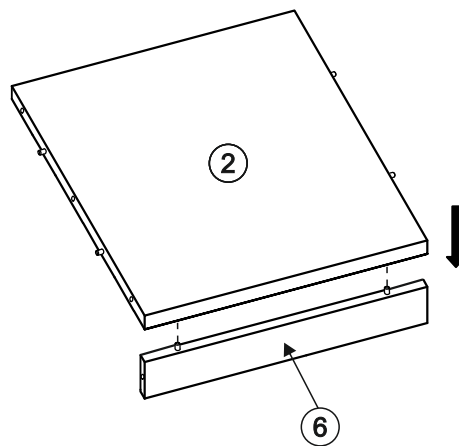
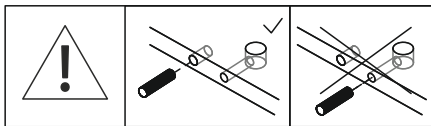
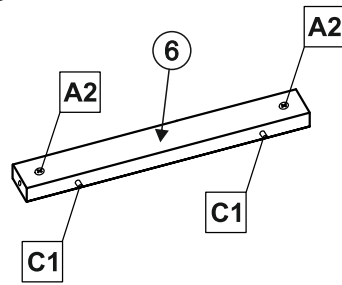
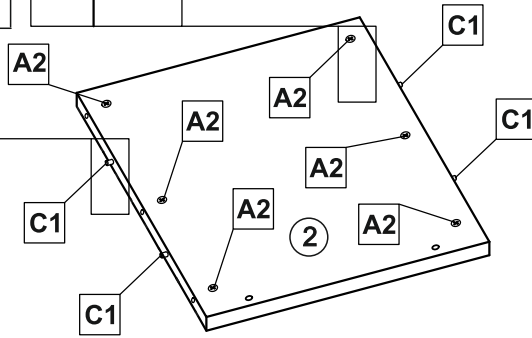
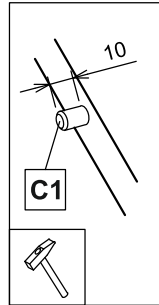
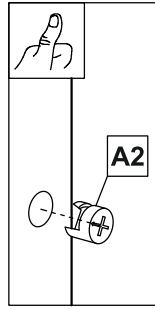
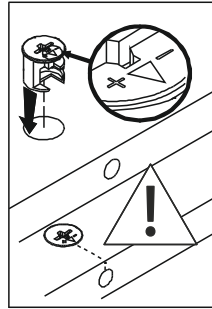
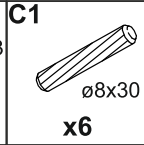
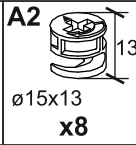



**4**

S1

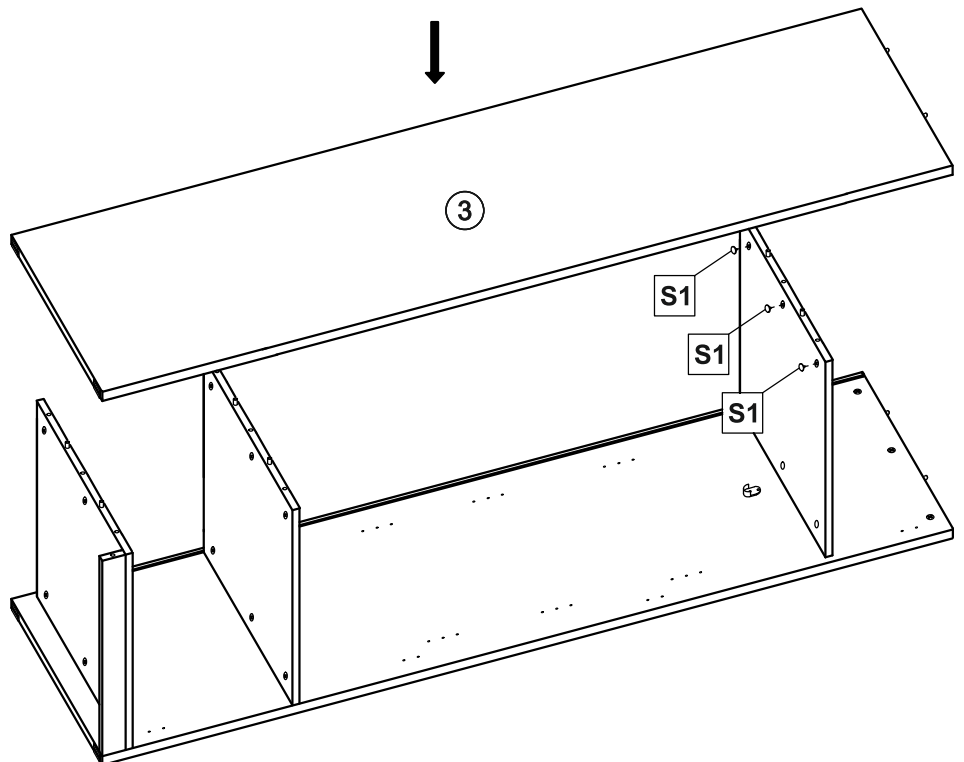
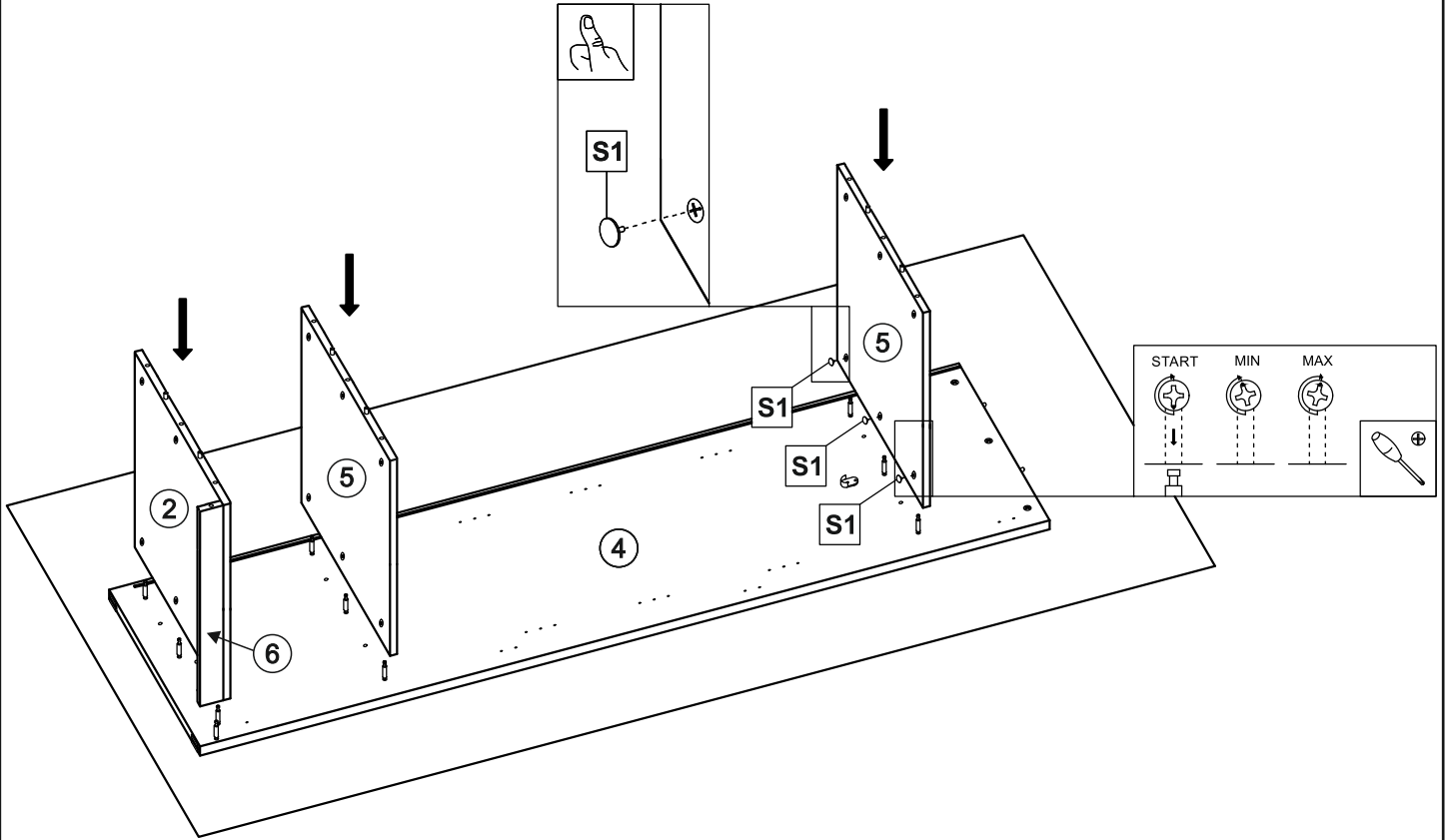

ø17x5  
x6



**5** S1   $\varnothing 17 \times 5$   
x6

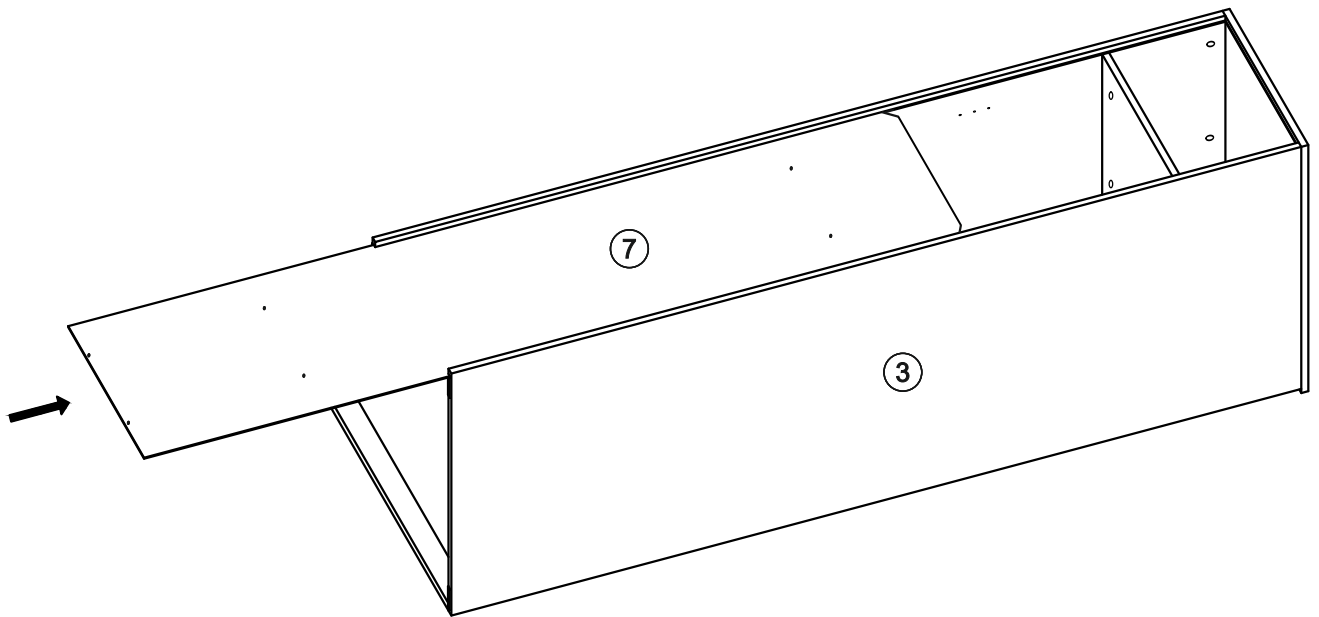
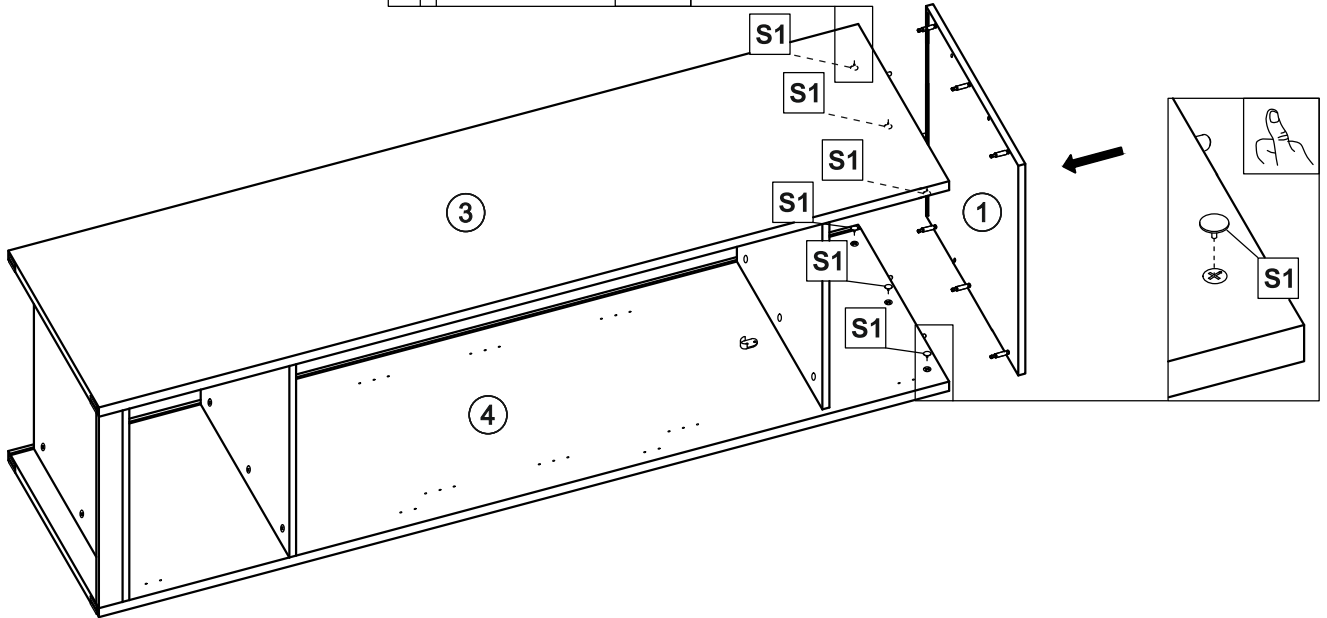
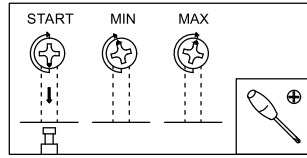

# 6

G1

14x15

x11





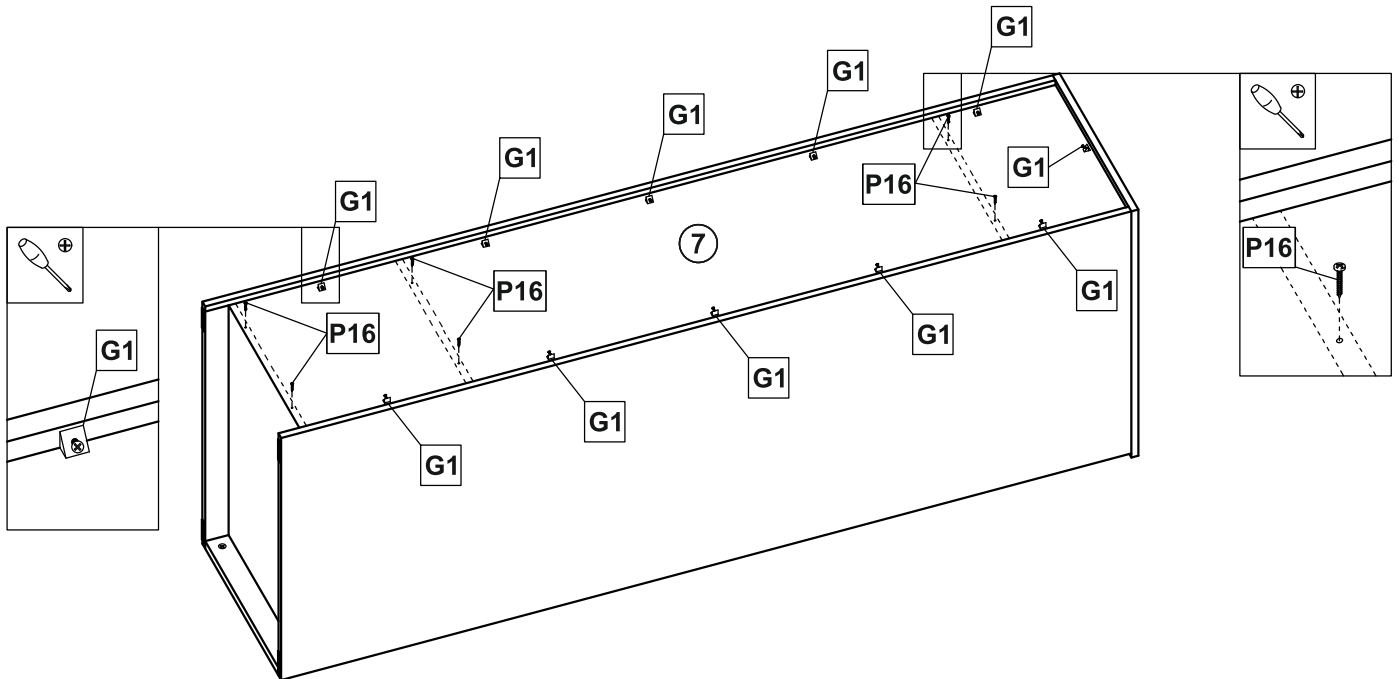
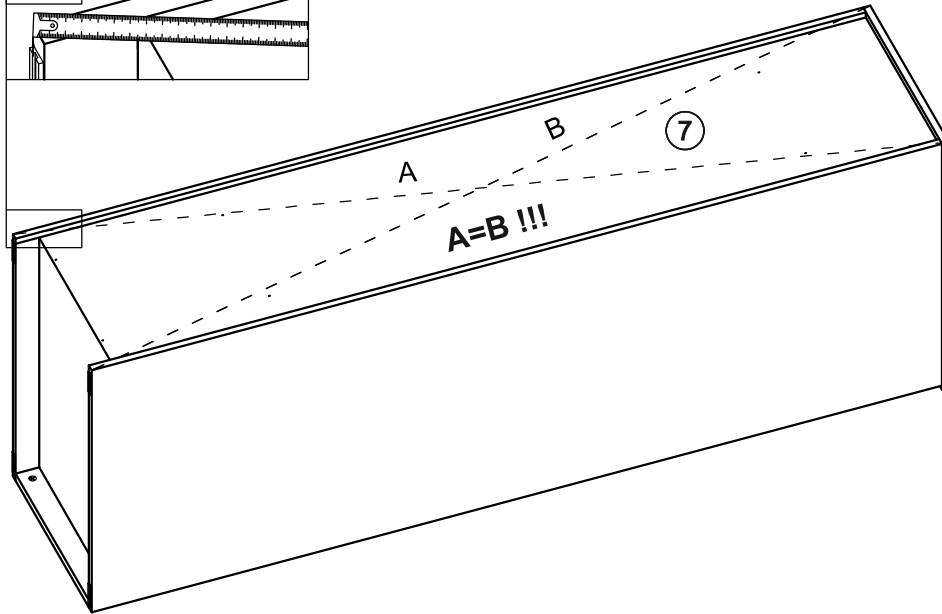
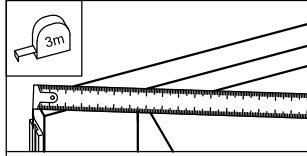

P16

Ø3,5x16

x6



<b>7</b>	<b>N9</b>  $\varnothing 4 \times 16$ <b>x1</b>	<b>P8</b>  $\varnothing 5 \times 50$ <b>x1</b>	<b>U4</b>  $\varnothing 10 \times 50$ <b>x1</b>	<b>V1</b>  $30 \times 75$ <b>x1</b>
----------	--	--	---	---

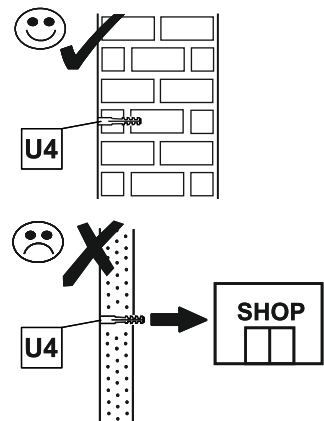
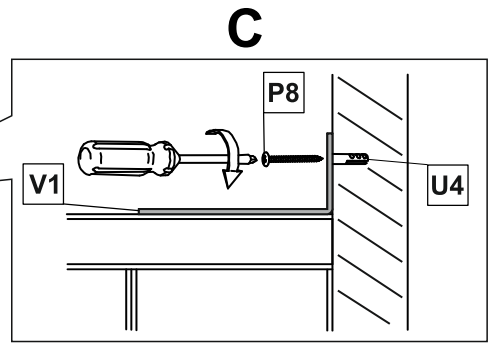
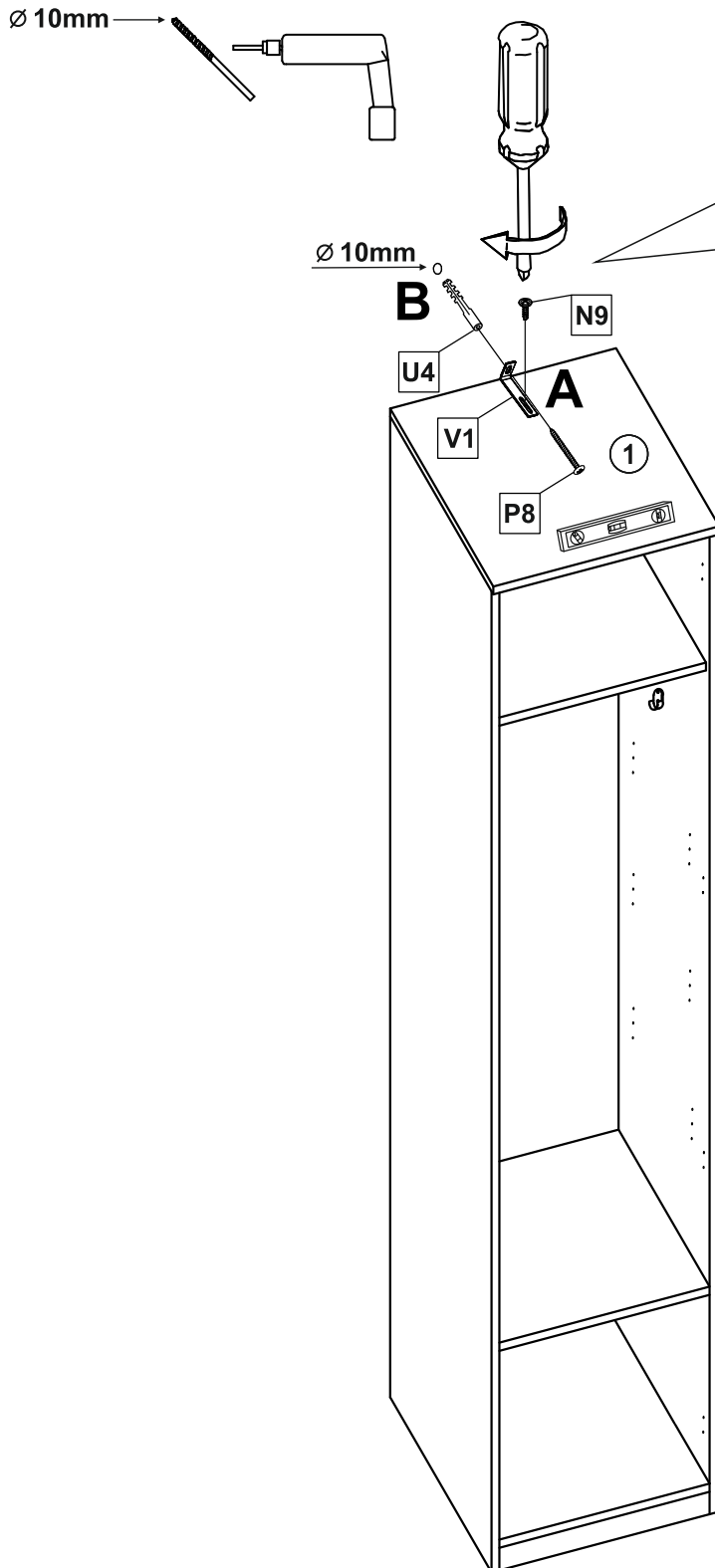
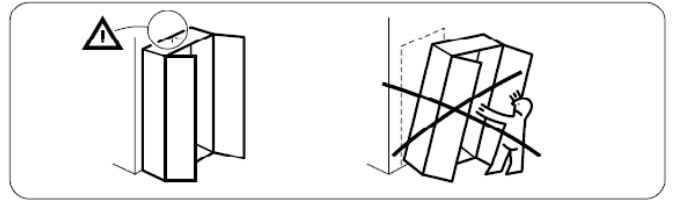

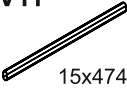
<b>8</b>	<b>H35+H36</b>	<b>V11</b>
	 <b>x4</b>	 <b>x1</b> 15x474

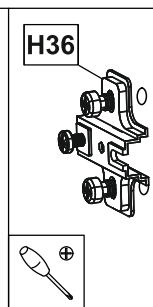
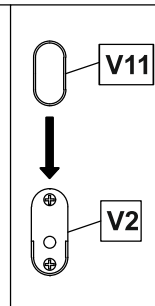
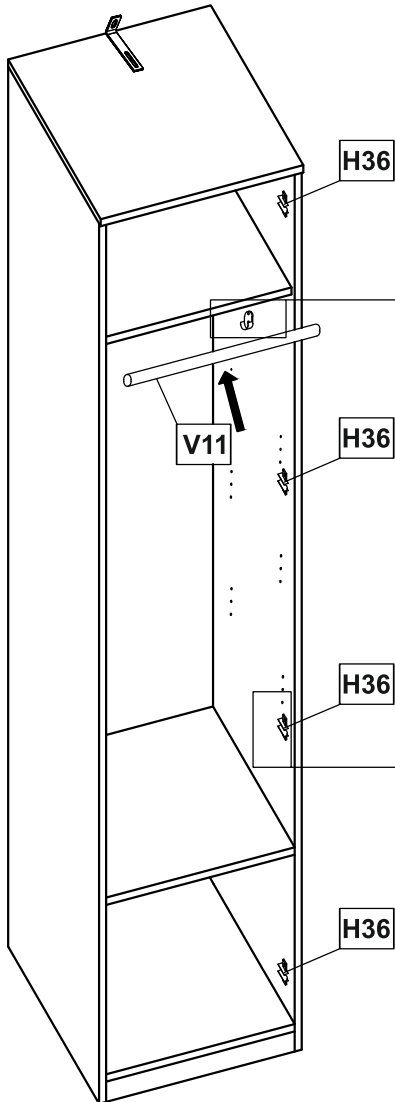
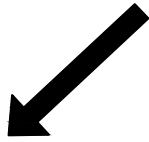
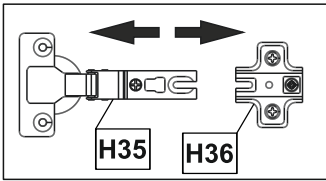
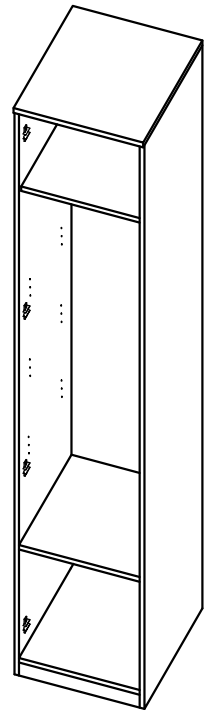
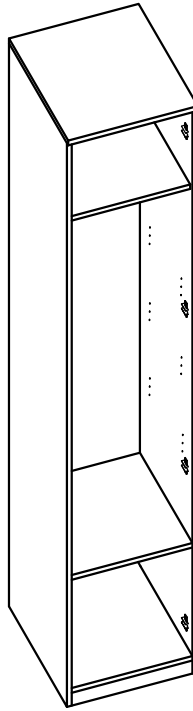

<b>9</b>	<b>H35</b>	<b>P16</b>
	<b>x4</b>	<b>x8</b>

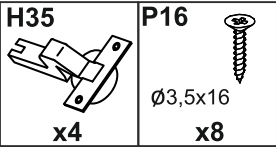

Ø3,5x16

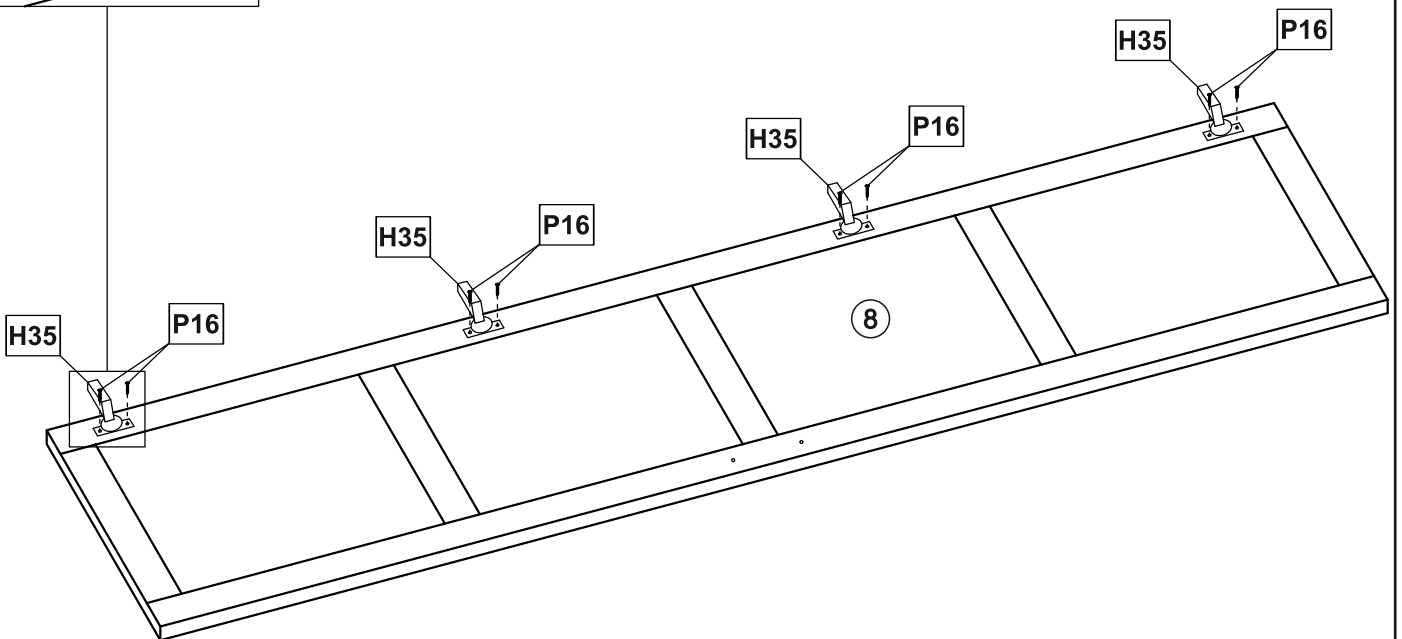
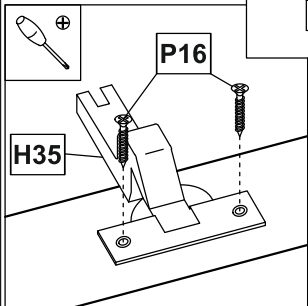
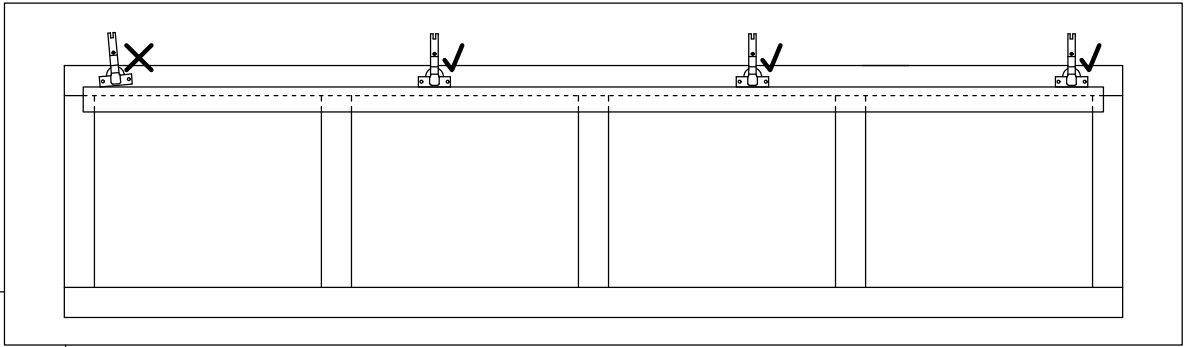

# 10

**I8**  
27x170  
x1

**J15**  
Ø4x30  
x2

**W2**  
Ø7x1  
x1

