

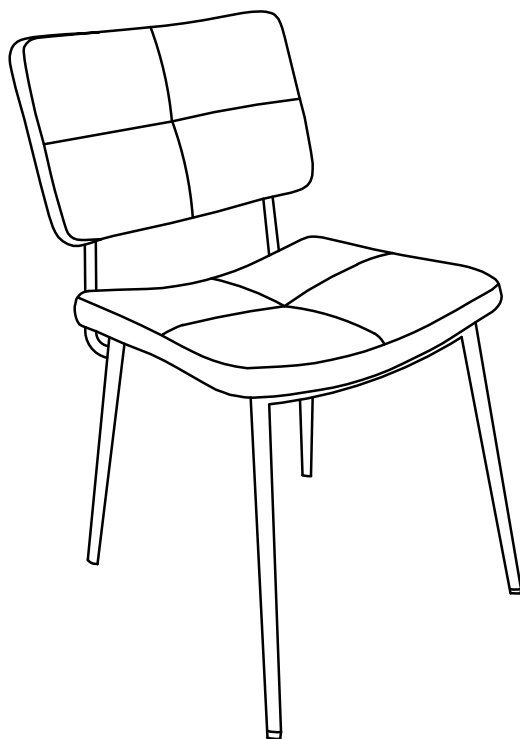

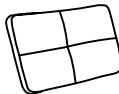







04890008-01/02/03

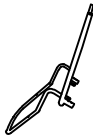

① x1	② x1	③ x2	④ x1	⑤ x1	A x12
					M6x16 
B x1	C x3	D x4	E x11		
5# 	M6x35 	φ6*18*1.5 	φ6*18*1.5 		

1

75%

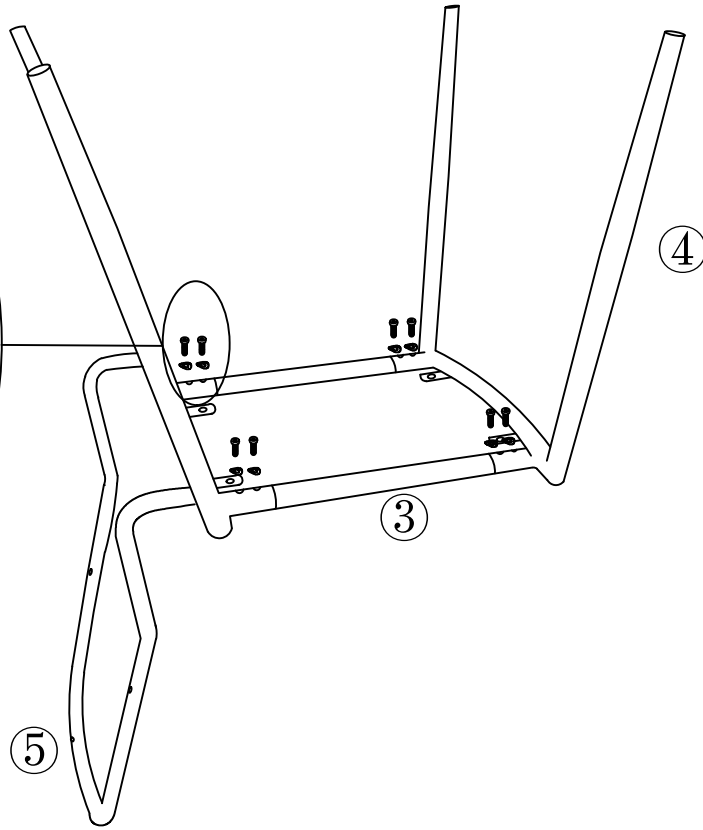
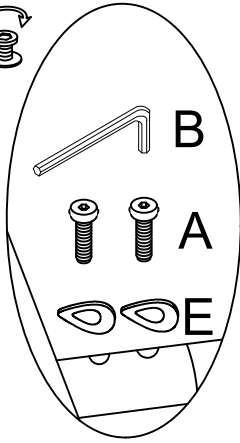

<b>Ax8</b>	<b>Bx1</b>	<b>Ex8</b>
M6x16	5#	φ6*18*1.5

2

75%

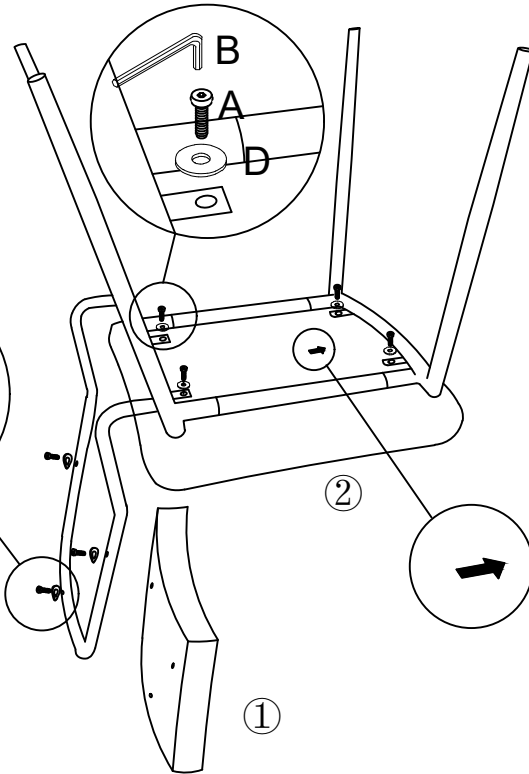
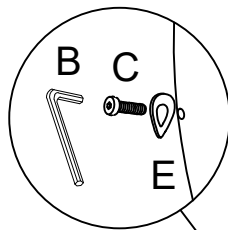

<b>Ax4</b>	<b>Bx1</b>	<b>Cx3</b>	<b>Dx4</b>	<b>Ex3</b>
M6x16	5#	M6x35	φ6*18*1.5	φ6*18*1.5

3

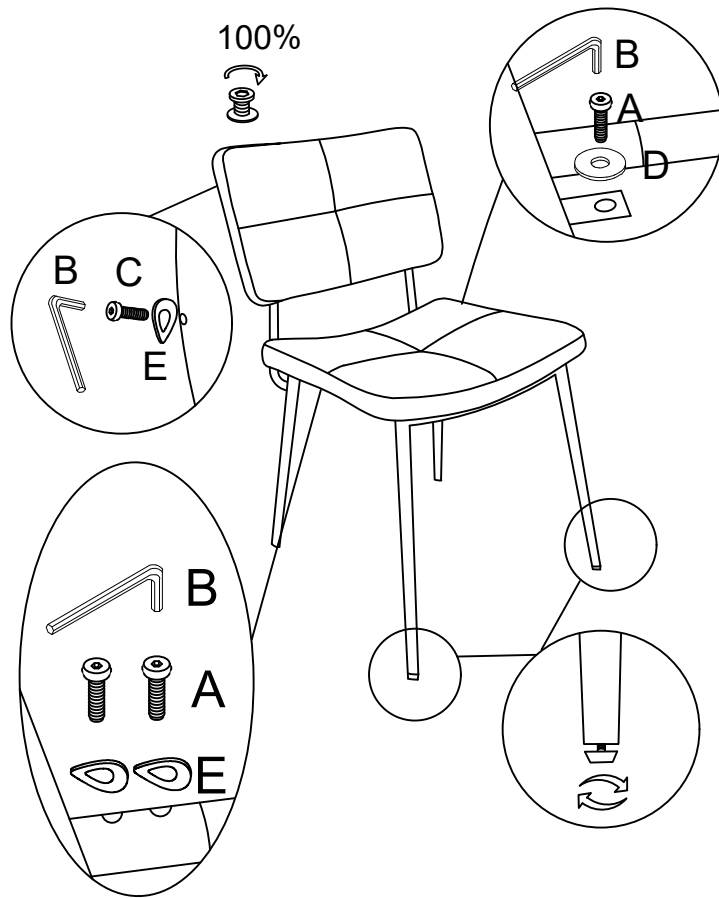

4

