

1803

PROFI PFR04

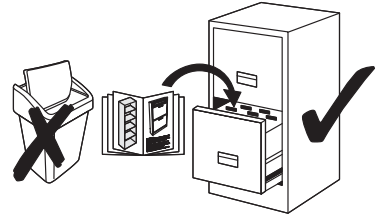
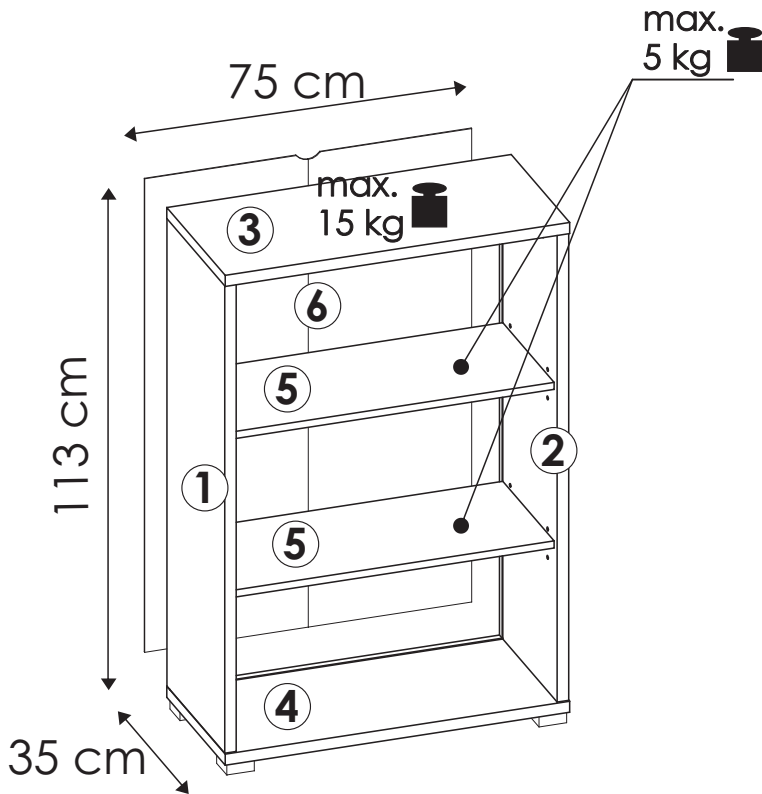

- | | | | | |
|------------------------------------|-----------------------------|------------------------------------|-------------------------------------|----------------------------|
| a1

8x35
x... (x8) | d6

x... (x8) | e0

x... (x4) | e1

x... (x4) | f1

x... (x4) |
| g2

7x60
x... (x4) | g0

x... (x4) | i2

4x16
x... (x1) | i11

4x30
x... (x8) | |
| m

x... (x1) | o13

x... (x4) | q9

x... (x1) | | |
| r4

x... (x8) | z

x... (x1) | | | |

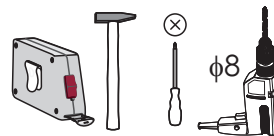
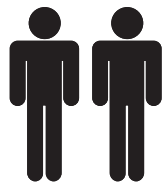
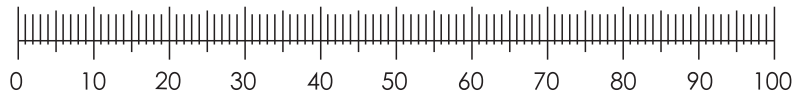

- 45 min.

1

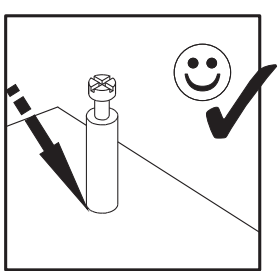
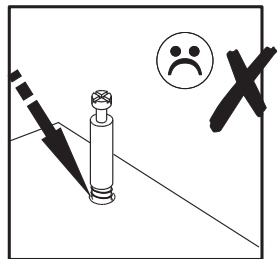
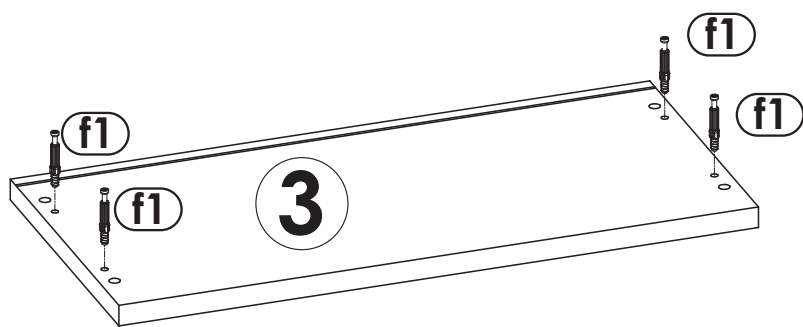
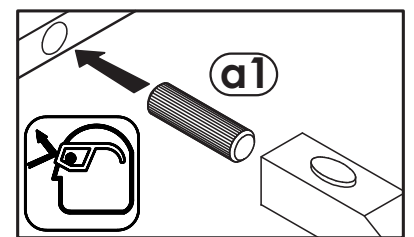
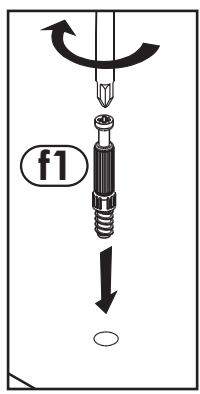
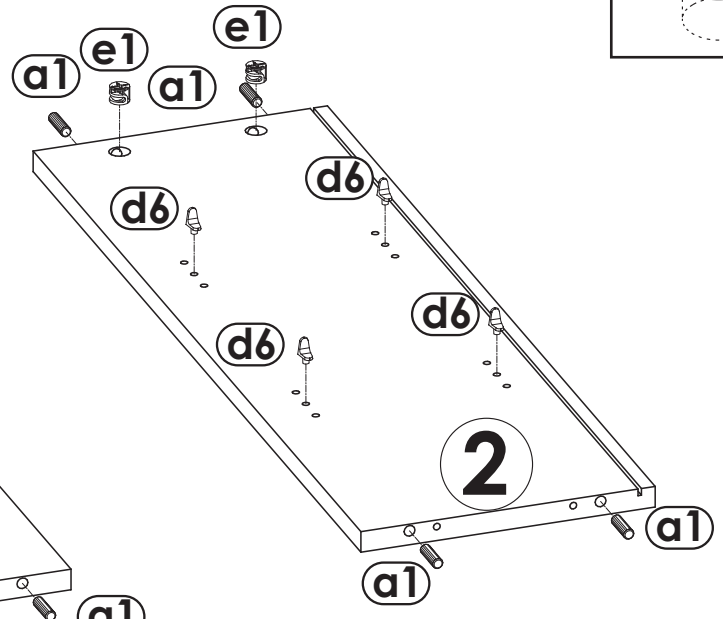
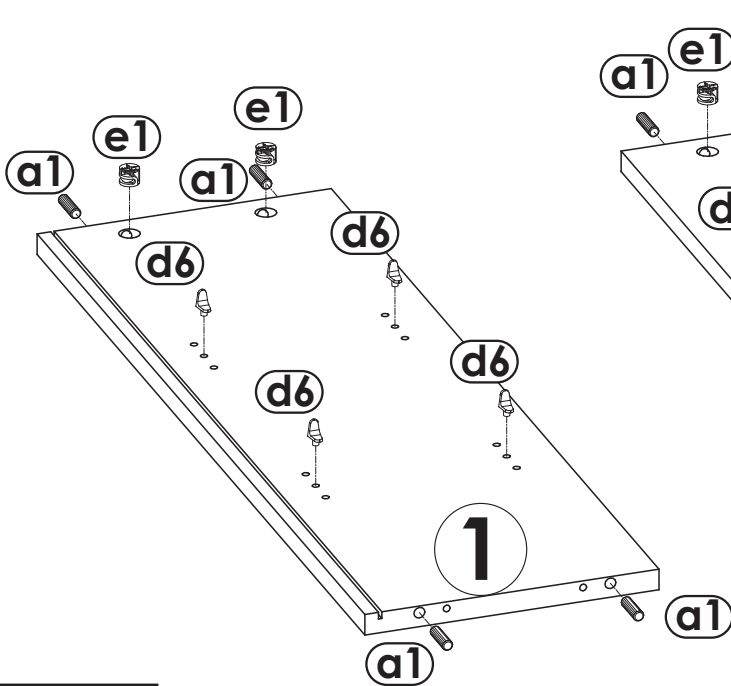
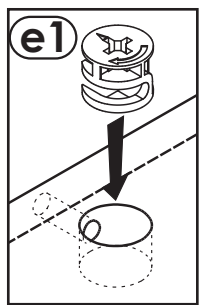
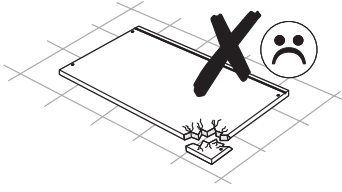
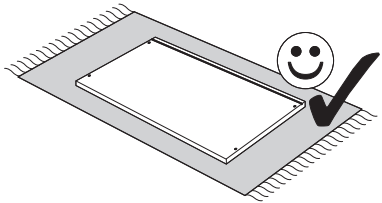

2

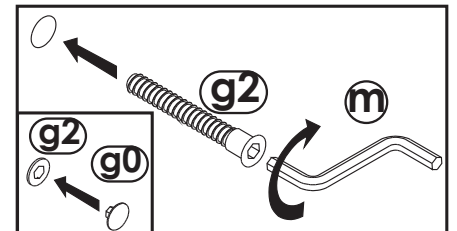
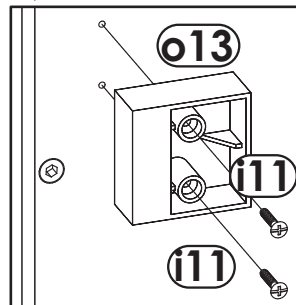
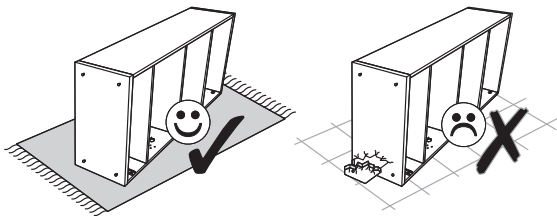
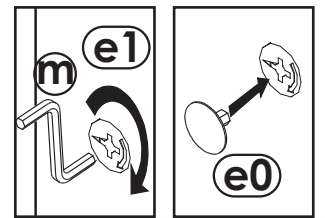
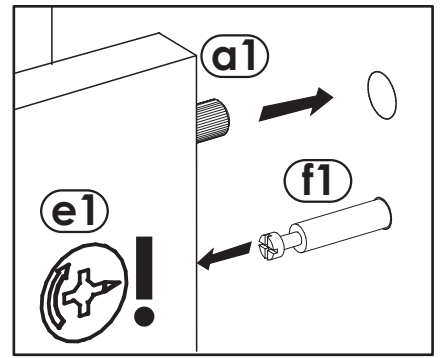
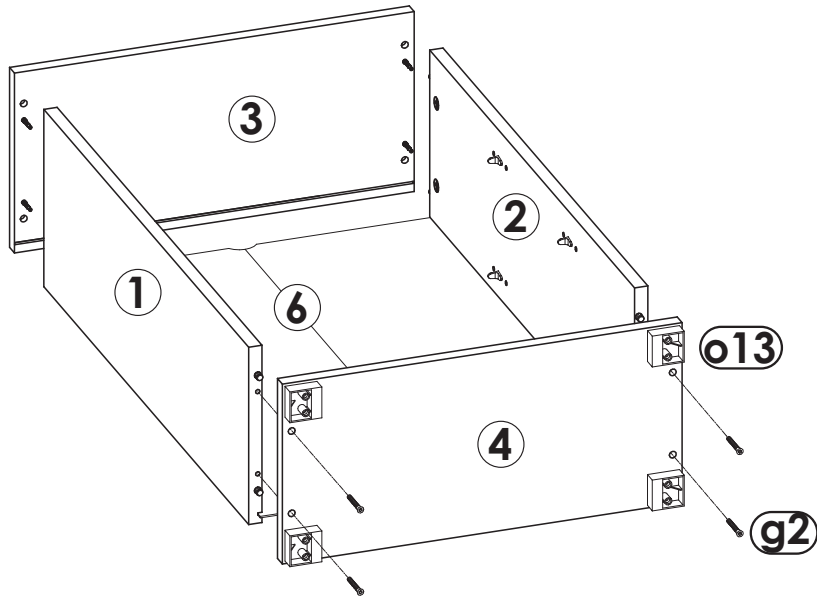

3

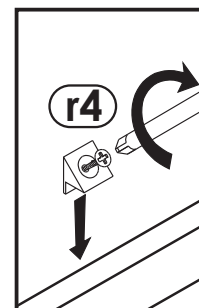
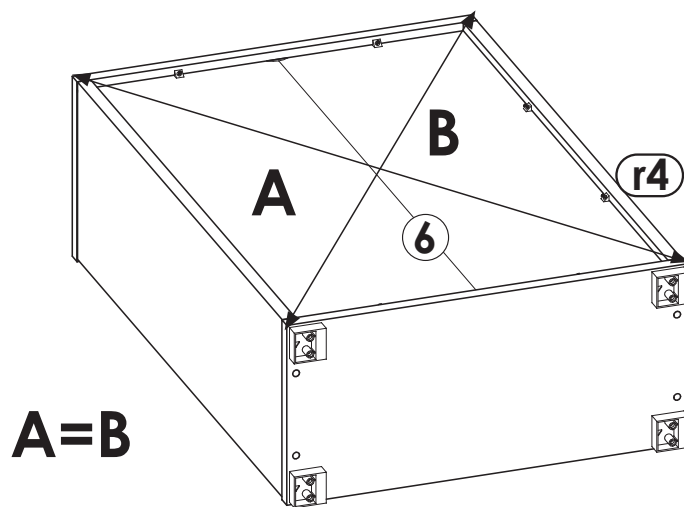
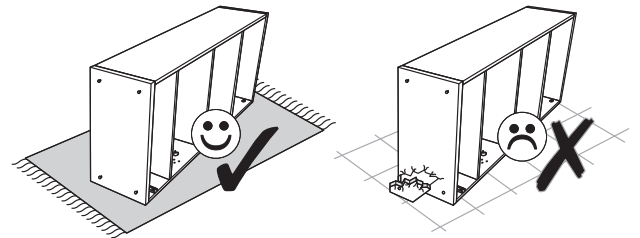

4
▼

