

Artikel.-Nr.:

6005-SB-22-1GL

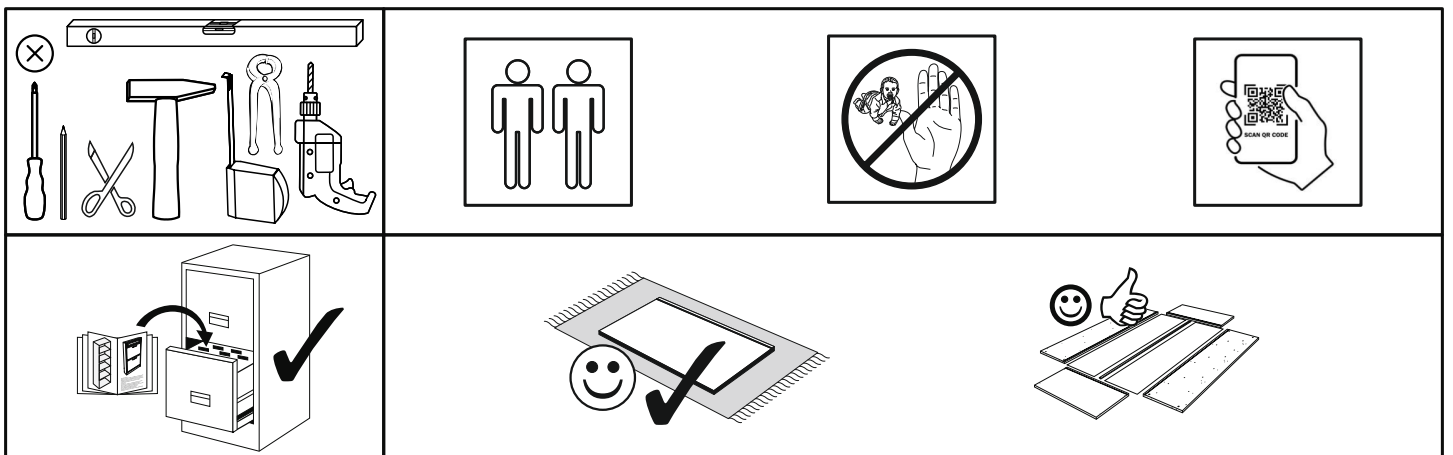









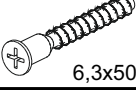





Montageanleitung.-Nr.:

MA1-00625

SCAN ME

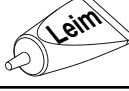
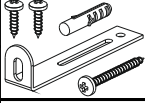
Das Ersatzteil-Anforderungsformular finden Sie auf
 The replacement parts requisition form you find on
<https://www.mausbacher.de/ersatzteile/>

BT1-00745 Colli 3/3

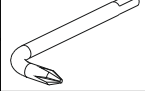

B01-10 16x  6,3x50	B01-190 32x  M4x20	B01-200 8x  6,3x13	B01-30 20x  3x16	B01-34 12x  4,0x30
B01-347 22x  5x8	B01-352 10x  M4	B01-80 8x  3,5x13	B01-90 6x  3,5x20	B02-160 8x 
B02-90 4x  6x30	B05-110 8x 	B05-130 1x 	B08-80 1x 	B02-103 16x  8x30
B02-10 24x  ø15x12mm	B02-20 24x 	B05-20 8x 	B01-244 1x 	

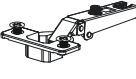
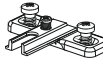

BT1-00743 Colli 3/3

B03-40 3x 	B03-10 3x 
---	---



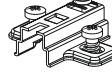

BT1-00005 Colli 3/3

B02-173 8x 	B01-123 16x  4,0x15
--	---

BT1-00700 Colli 3/3

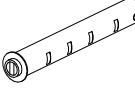
B03-41 4x 	B03-11 4x 
---	---

BT1-00746 Colli 3/3

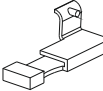
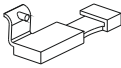
B03-131 3x 	B03-158 3x 	B05-01 2x  ø14mm	B05-185 6x 
B05-300 4x 	B05-301 2x 	B05-302 2x 	

Colli 2/3



1564 x 394

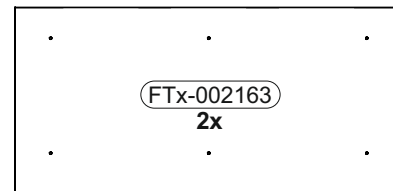

864 x 417

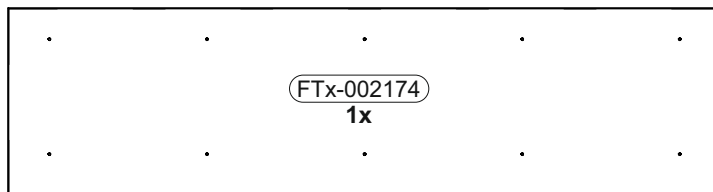

1588 x 419

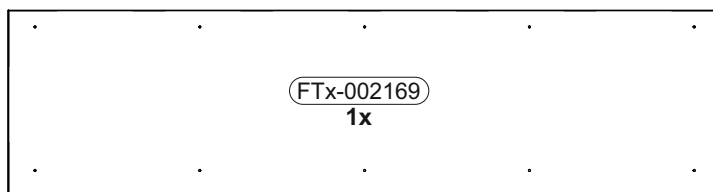

1588 x 419

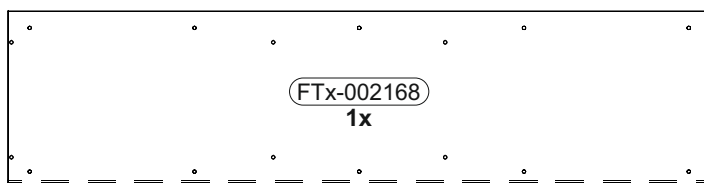

1564 x 394



Colli 1/3

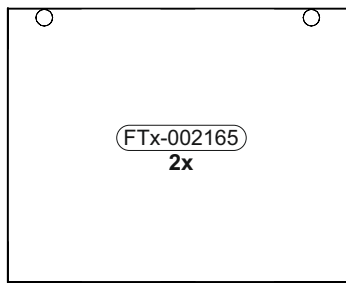

721 x 580

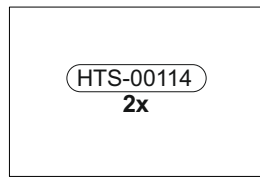

538 x 358

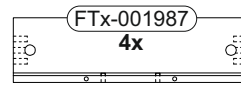

335 x 92

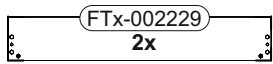

557 x 82

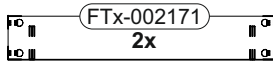

568 x 92

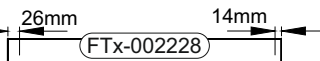

580 x 136

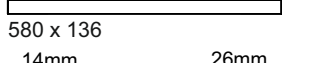

580 x 136

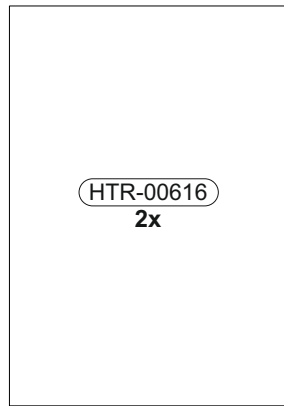

846 x 589

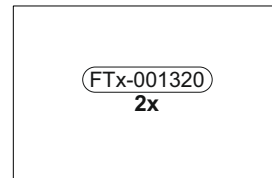

568 x 365

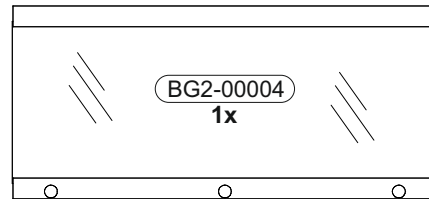

860 x 392

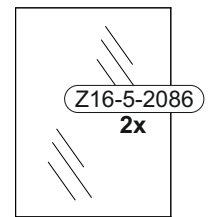

368 x 274

Colli 3/3

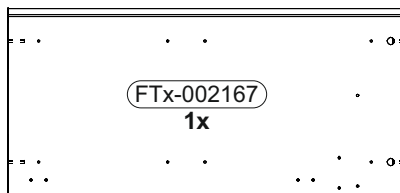

834 x 394

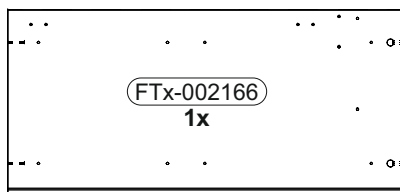

834 x 394

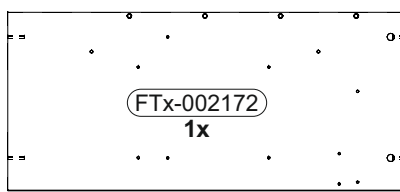

834 x 377

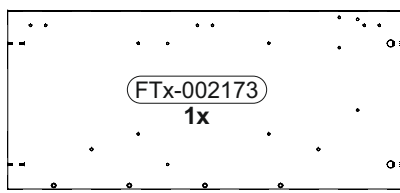

834 x 377

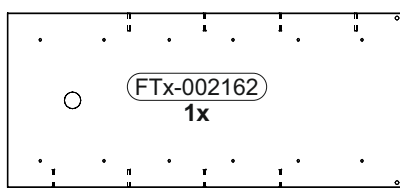

834 x 368

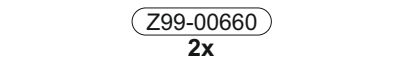

834 x 25

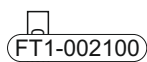

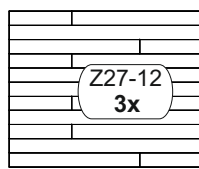

250 x 14

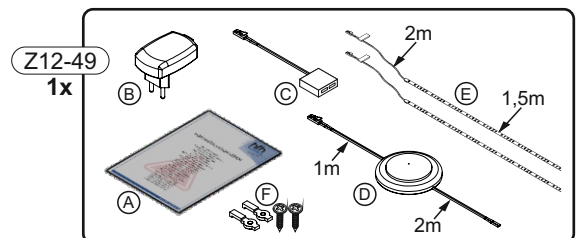
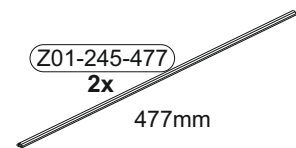
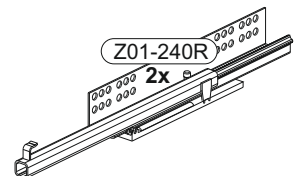
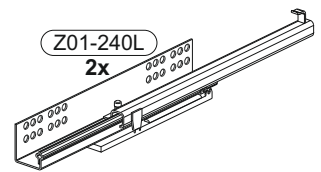

340 x 275



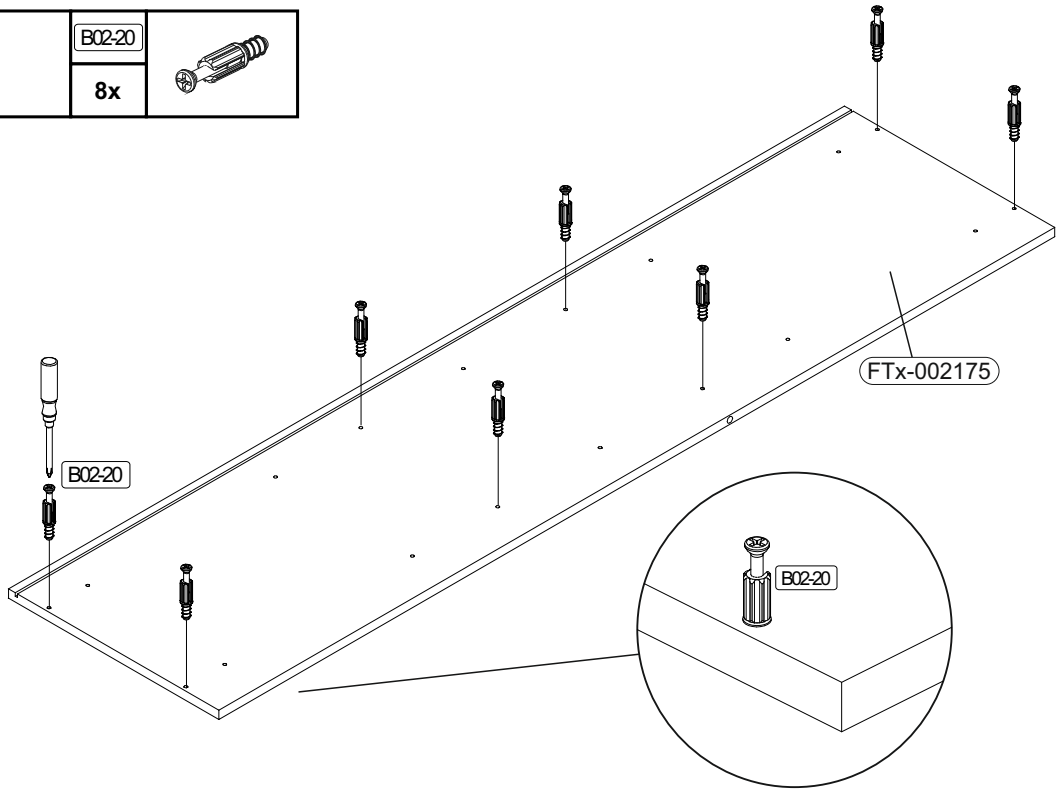

1

	B02-20	
	8x	



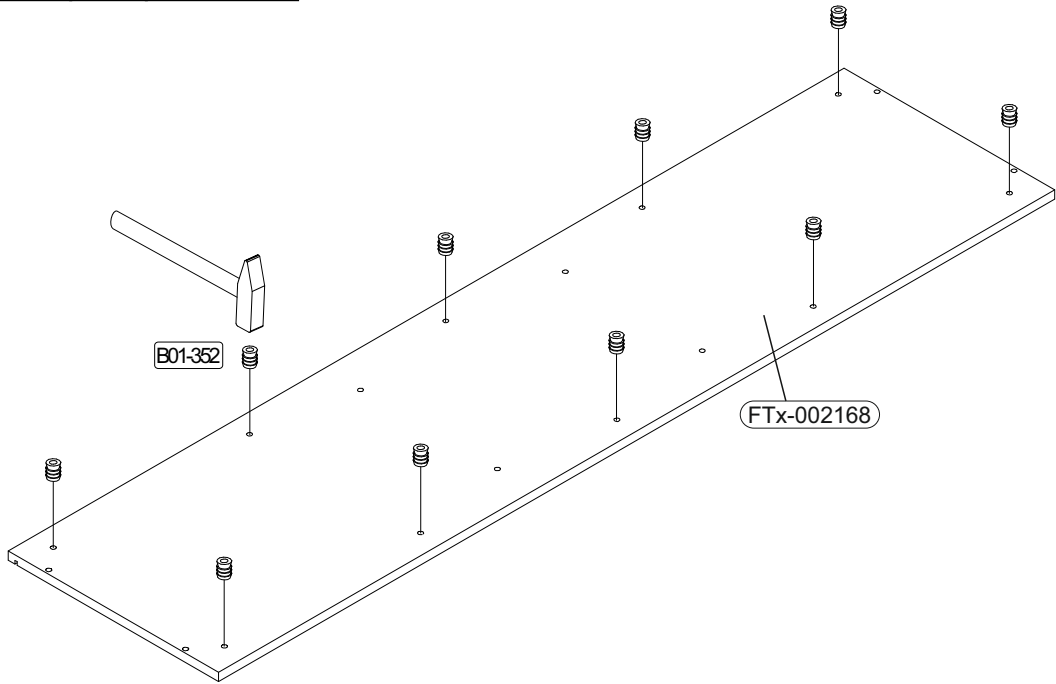

2

	B01-352	
	10x	M4



3

	B02-90	
	4x	
	B05-130	
	1x	Leim

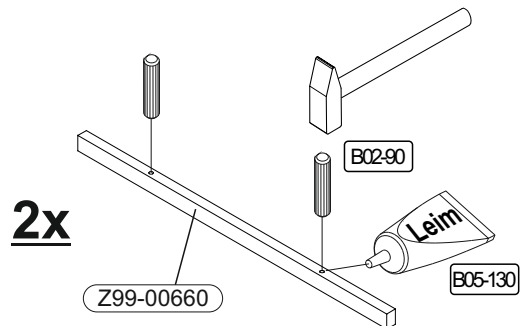

6

	B02-10		B05-110		B01-200		B02-20		B03-10	
	2x	$\varnothing 15 \times 12 \text{mm}$	4x		2x	$6,3 \times 13$	2x		3x	
								B05-130		
								1x		

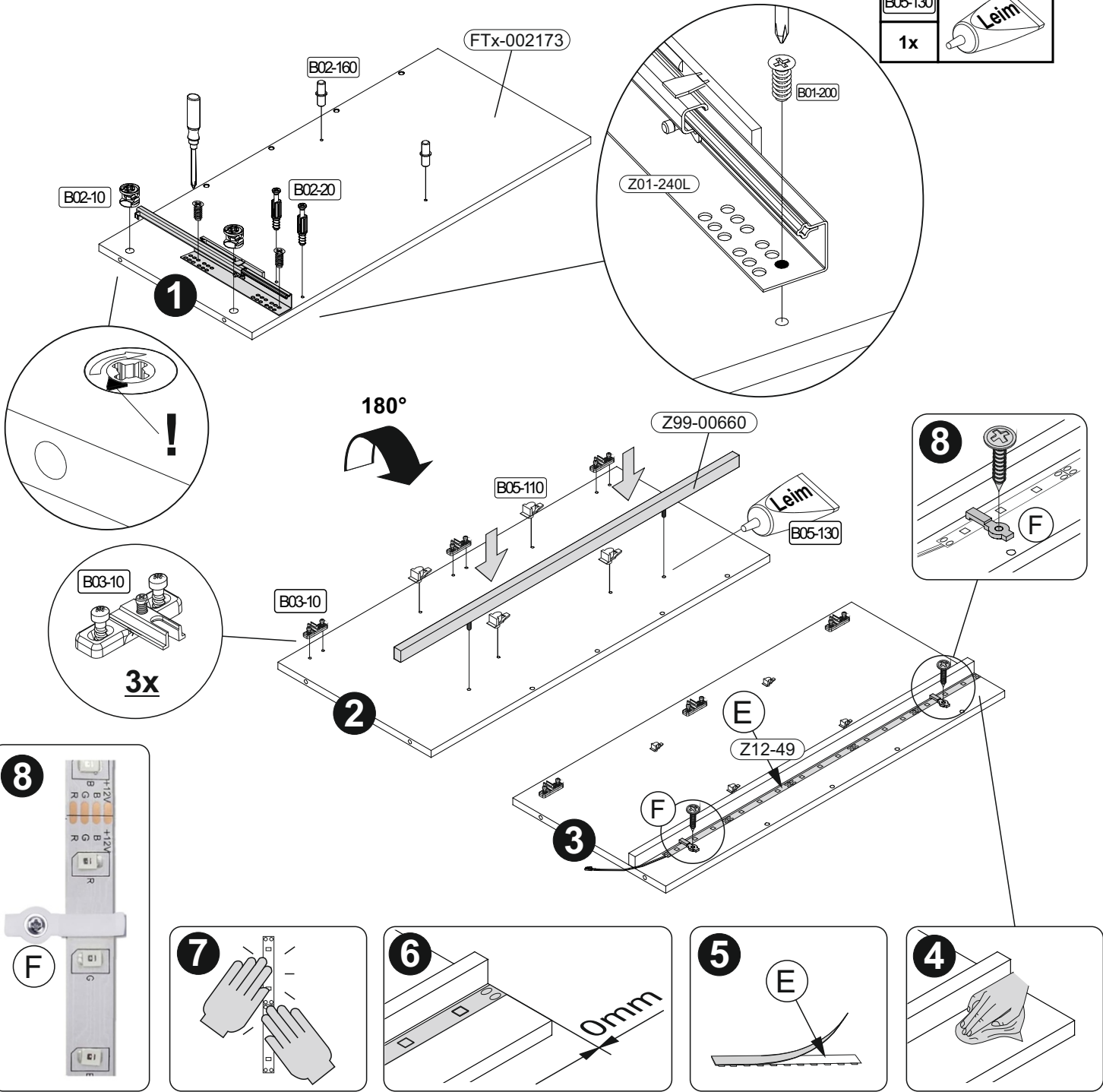





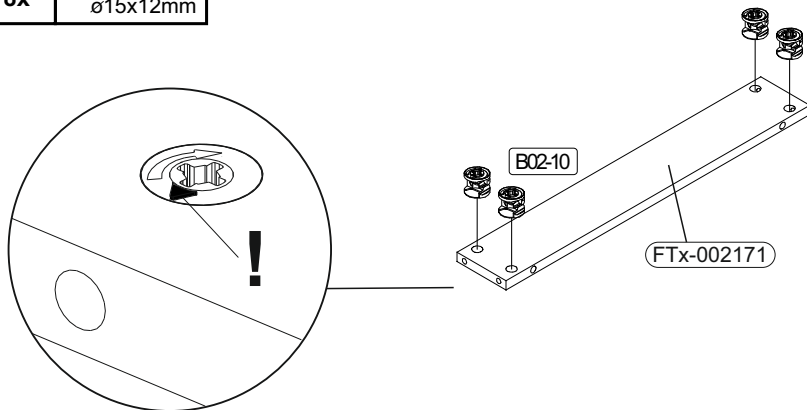

7

	B02-10	
	8x	$\varnothing 15 \times 12 \text{mm}$





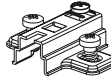

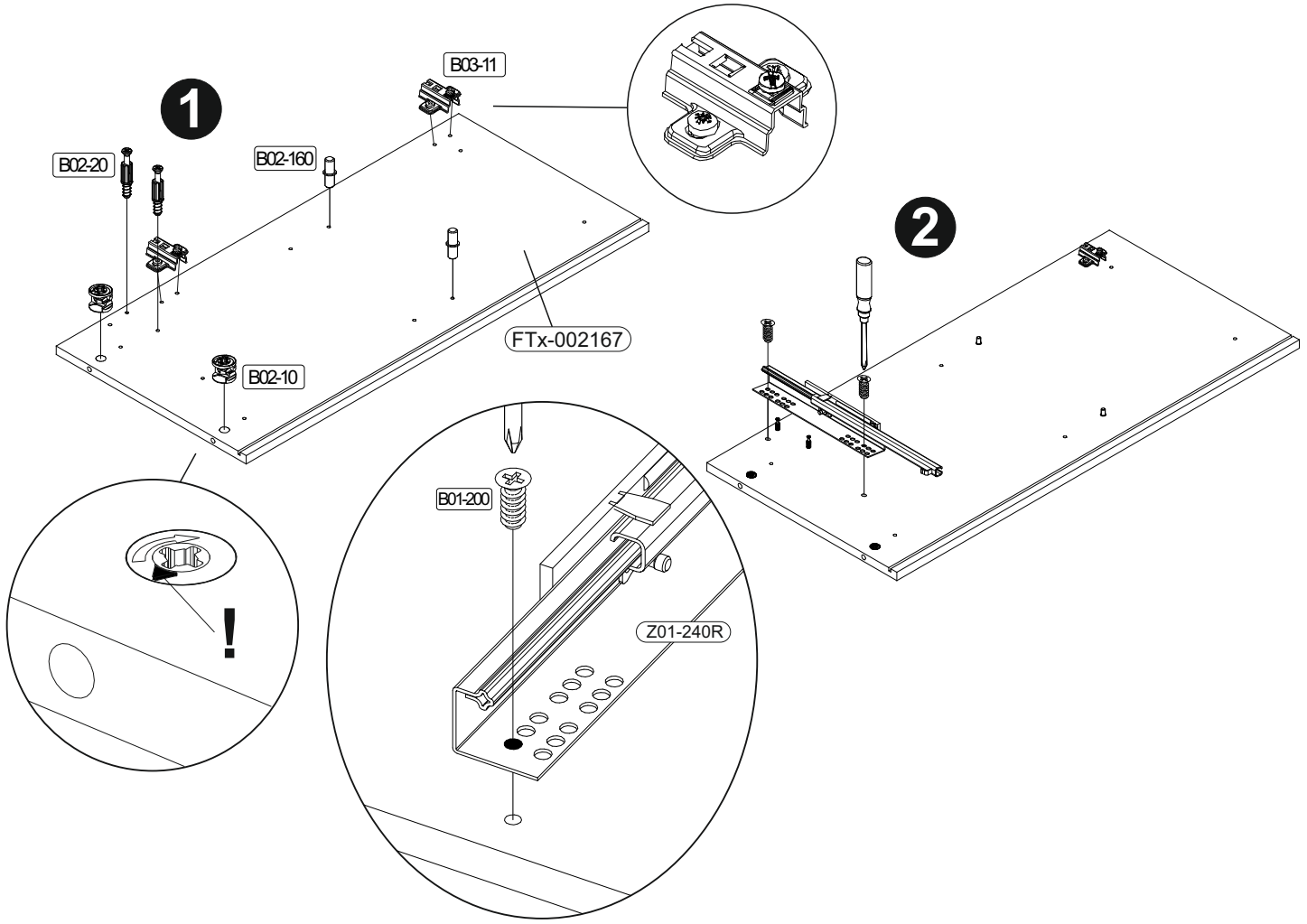

2x

8

						
	2x	2x	2x	2x	2x	2x

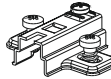

9

						
	2x	2x	2x	2x	2x	2x

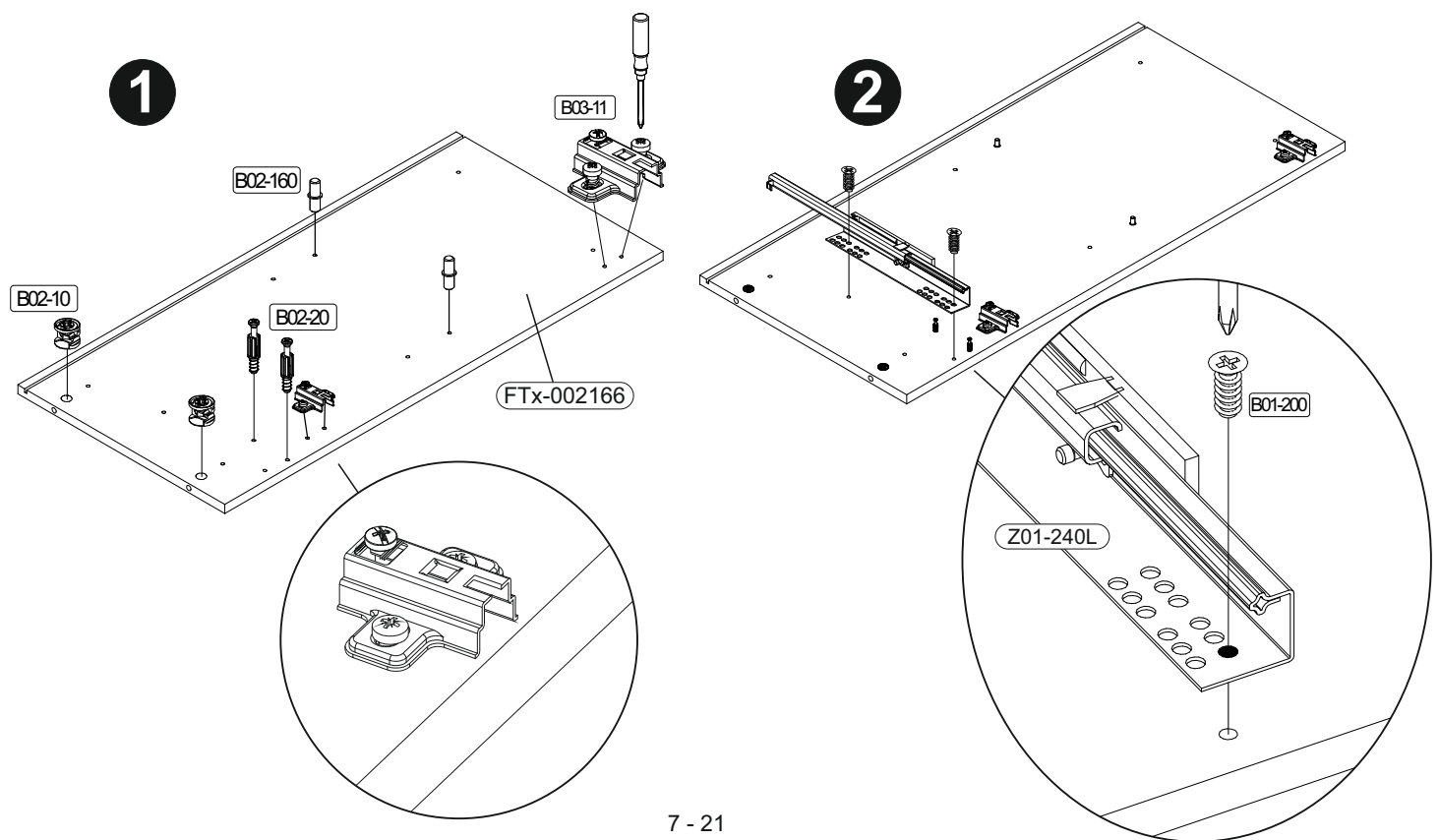

10

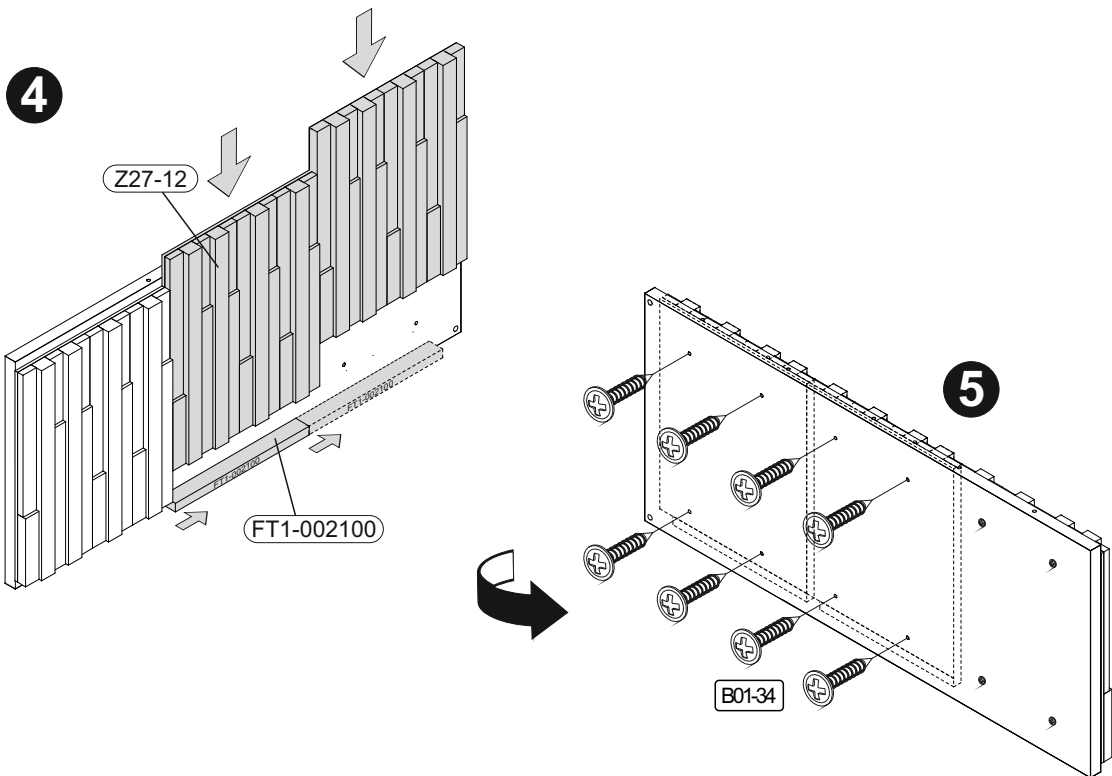
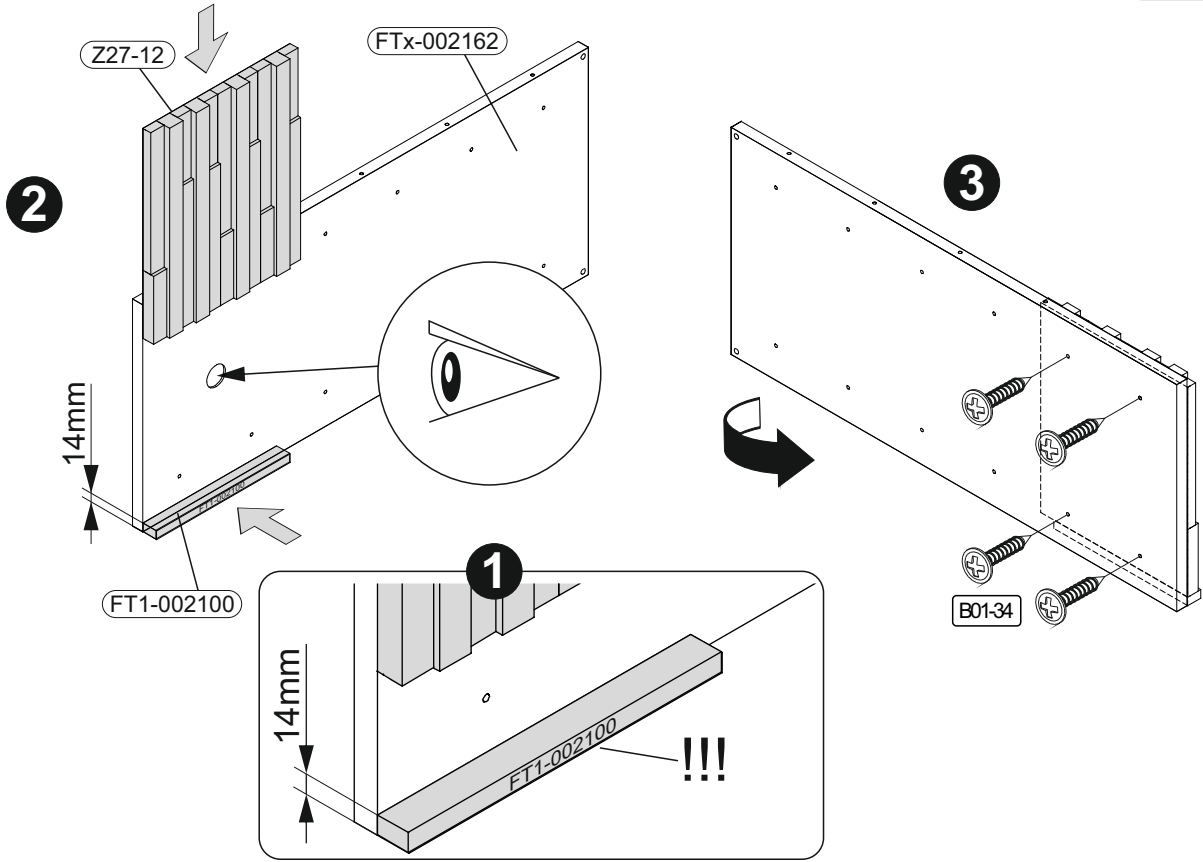
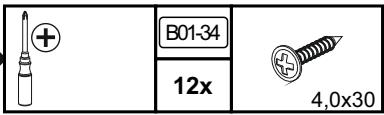

Informationen zu Massivholzrückwänden:

Wir gratulieren Ihnen zu Ihrem neuen Möbelstück mit Massivholzelementen. Massivholz ist ein natürliches und lebendiges Material, das Ihrem Zuhause eine warme und einzigartige Atmosphäre verleiht.

Wichtige Hinweise zu den Eigenschaften von Massivholz:

- Jedes Stück Massivholz ist einzigartig. Unterschiede in Farbe, Maserung und Struktur sind charakteristische Merkmale und machen Ihr Möbelstück zu einem Unikat.
- Wurmlöcher und Spuren von Käfern sind natürliche Merkmale, die bei echtem Massivholz auftreten können. Diese kleinen Unregelmäßigkeiten sind ein Zeichen der Echtheit und zeugen von der natürlichen Herkunft des Materials.
- Diese natürlichen Variationen sind kein Reklamationsgrund, sondern ein Zeichen der Authentizität und Individualität des Holzes.
- Massivholz reagiert auf Veränderungen in Temperatur und Luftfeuchtigkeit. Es kann sich ausdehnen oder zusammenziehen, was zu kleinen Rissen oder Veränderungen in der Form führen kann.
- Diese Anpassungen sind normale Eigenschaften von Massivholz und beeinträchtigen weder die Funktion noch die Haltbarkeit Ihres Möbelstücks.
- Vermeiden Sie extreme Bedingungen wie direkte Sonneneinstrahlung, hohe Luftfeuchtigkeit oder Trockenheit, um übermäßige Bewegungen des Holzes zu minimieren.

Bitte beachten Sie: Die oben genannten Eigenschaften sind keine Reklamationsgründe, sondern natürliche Merkmale von Massivholz. Wir sind stolz darauf, Ihnen ein Produkt anbieten zu können, das die Schönheit und Einzigartigkeit der Natur in Ihr Zuhause bringt.

D

GB

Information about Solid Wood Back Panels:

Congratulations on your new furniture piece with solid wood elements. Solid wood is a natural and living material that brings a warm and unique atmosphere to your home.

Important notes on the characteristics of solid wood:

- Each piece of solid wood is unique. Variations in color, grain, and texture are characteristic features and make your furniture piece one of a kind.
- Wormholes and beetle traces are natural features that can occur in genuine solid wood. These small irregularities are a sign of authenticity and testify to the natural origin of the material.
- These natural variations are not grounds for complaint but rather a sign of the authenticity and individuality of the wood.
- Solid wood reacts to changes in temperature and humidity. It can expand or contract, which may result in small cracks or changes in shape.
- These adjustments are normal properties of solid wood and do not affect the function or durability of your furniture piece.
- Avoid extreme conditions such as direct sunlight, high humidity, or dryness to minimize excessive movement of the wood.

Please note: The above-mentioned characteristics are not grounds for complaints but natural features of solid wood. We are proud to offer you a product that brings the beauty and uniqueness of nature into your home.

11

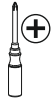
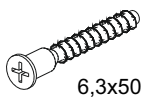
	B01-10	
8x		6,3x50

1

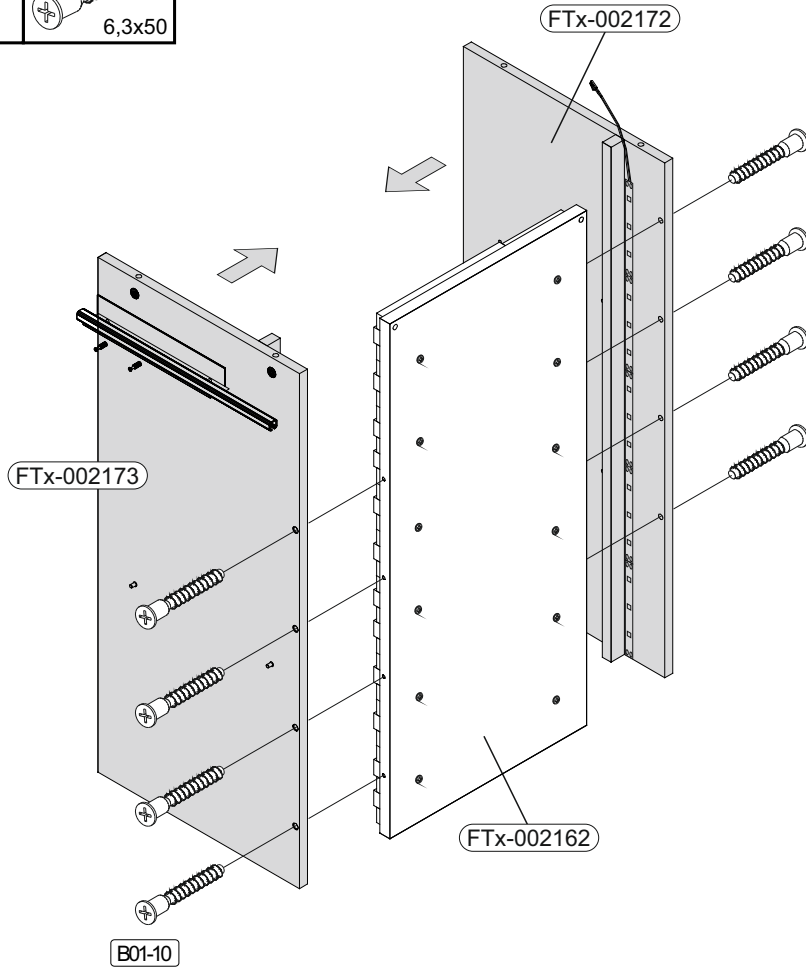

90°



2

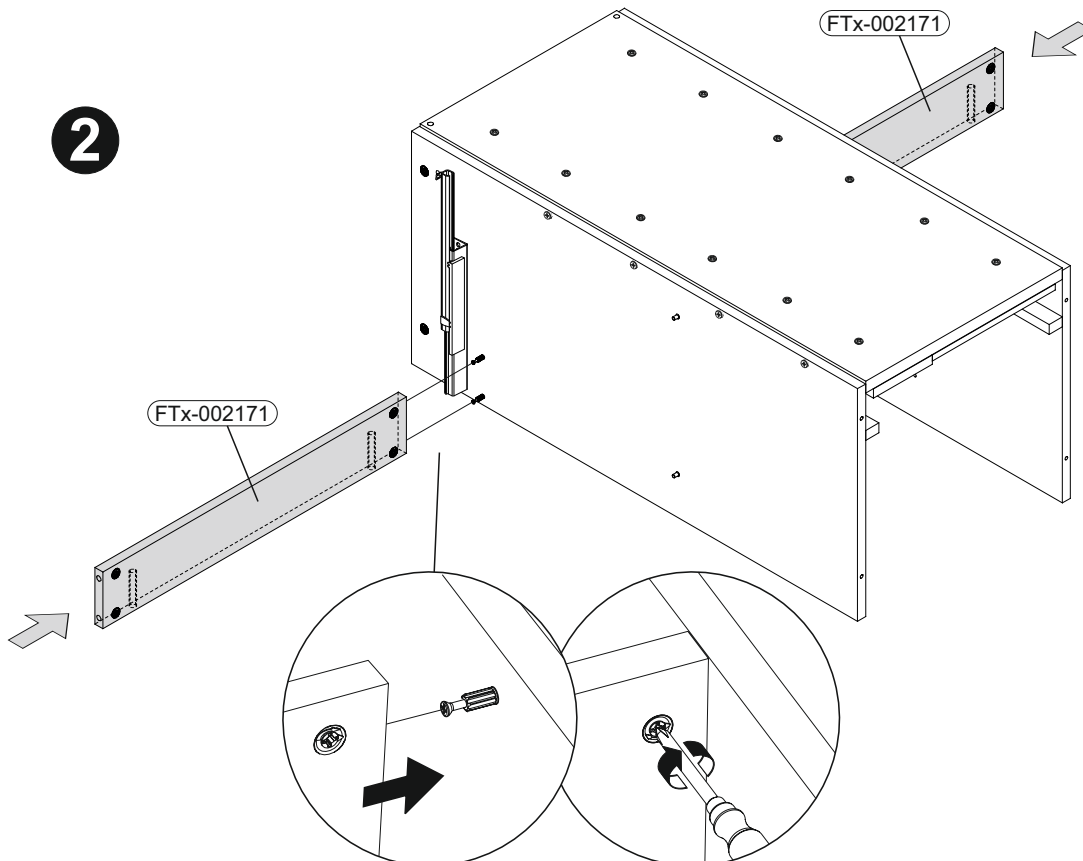

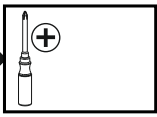
12 

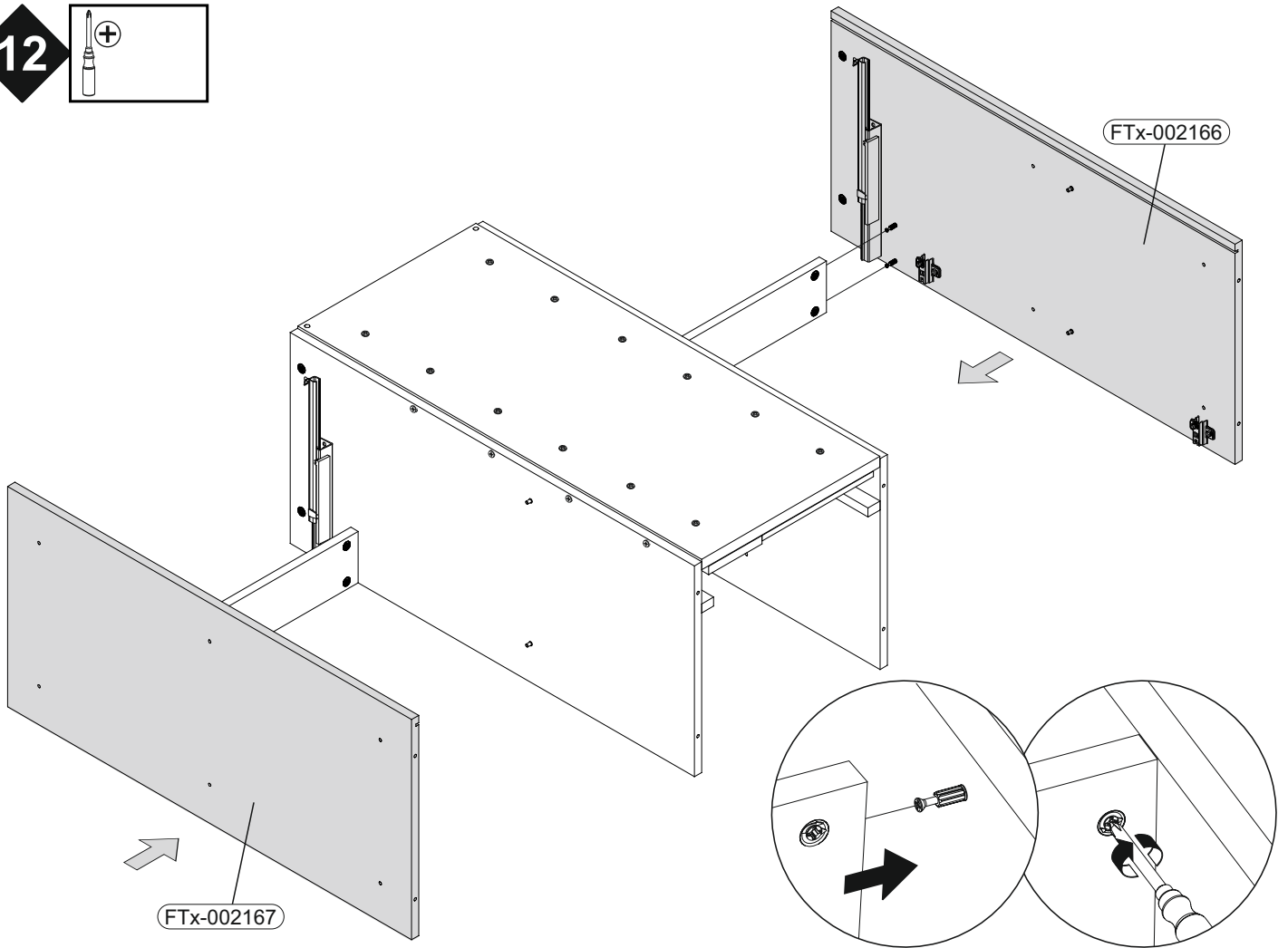

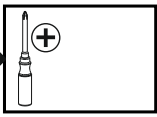
13 

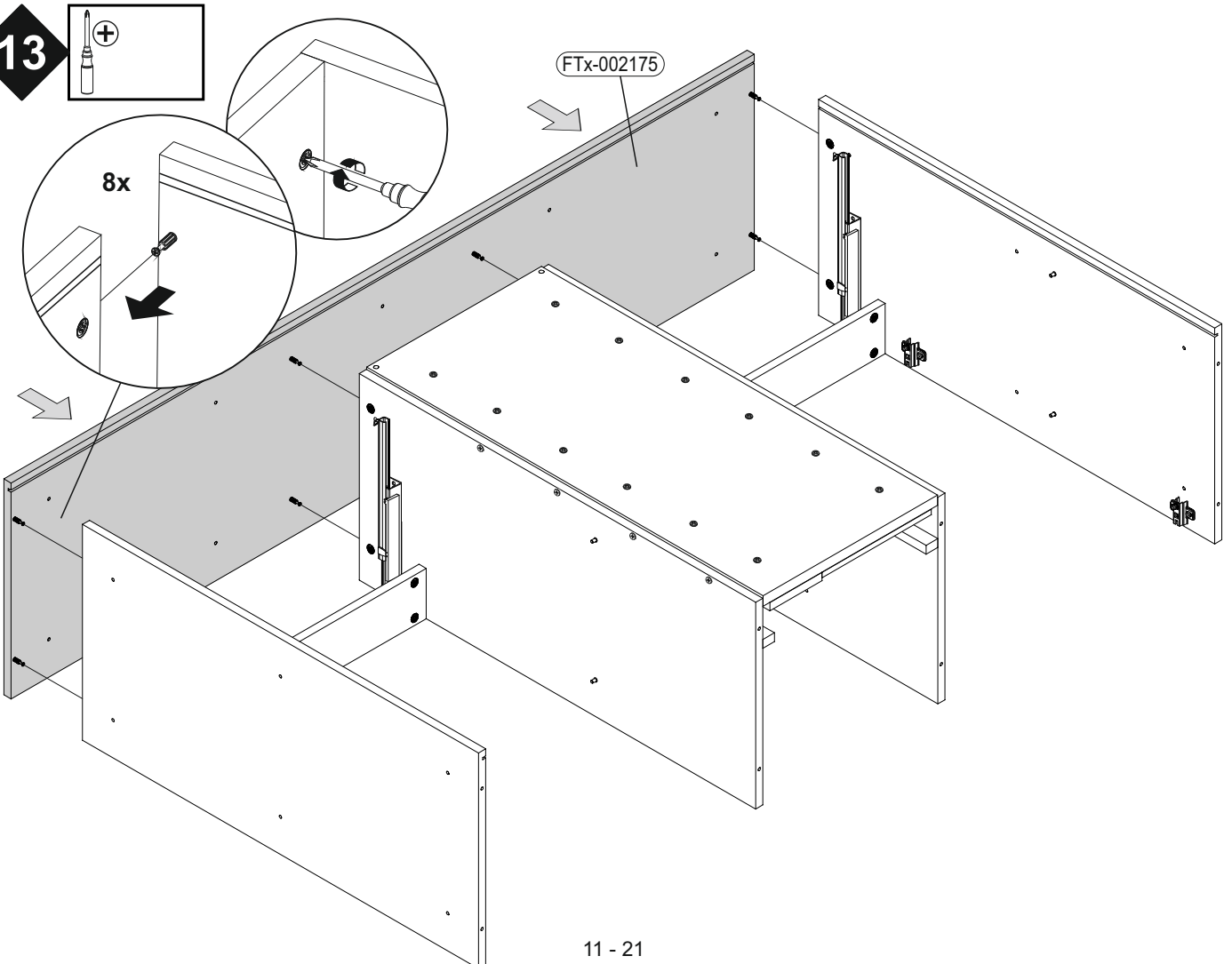



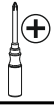
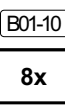
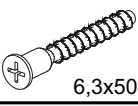

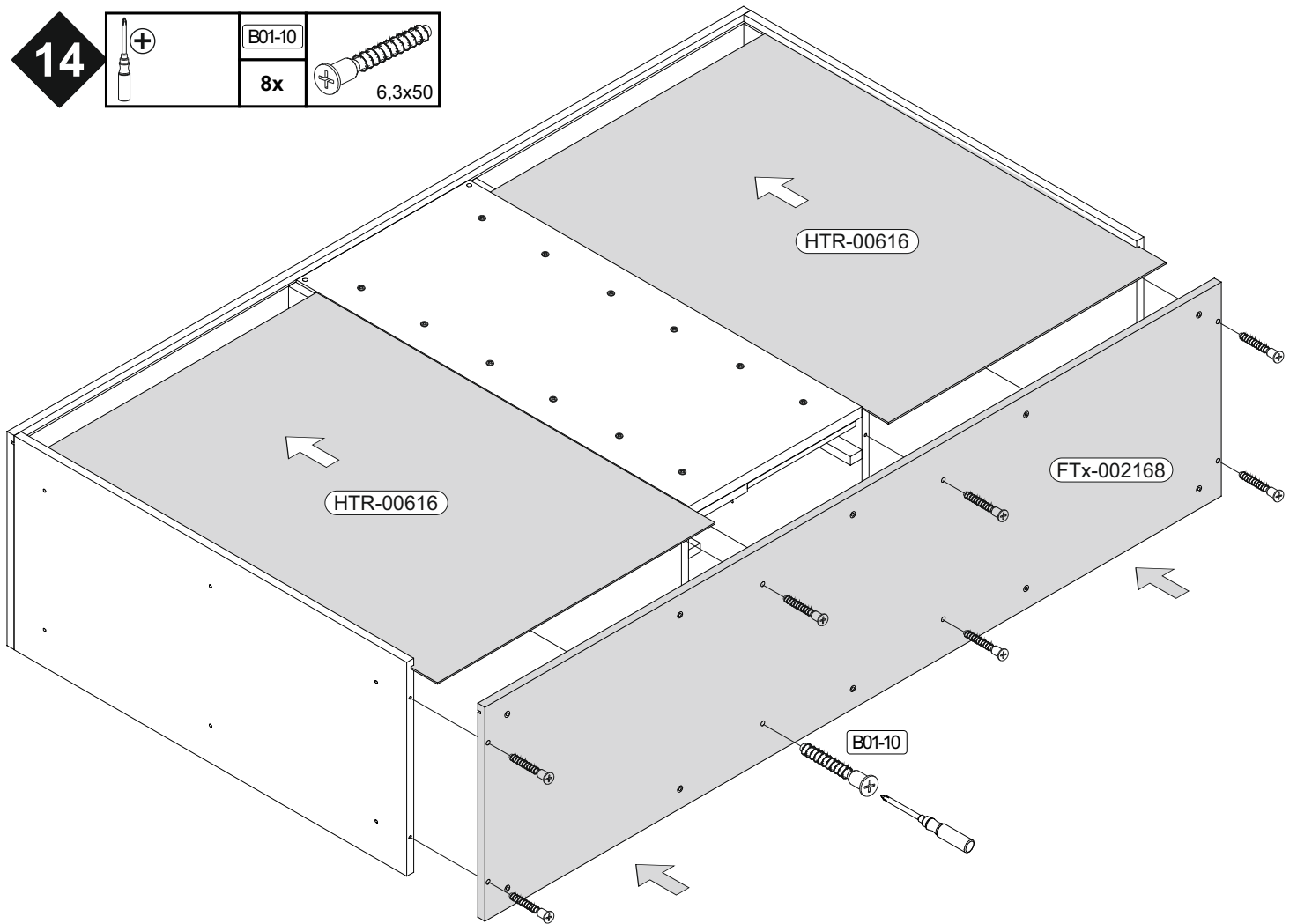
14

		
	B01-10	6,3x50
	8x	

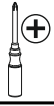

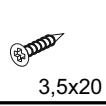
15

			
	B01-90	B05-185	
	6x	3,5x20	6x
	B01-30		
	10x	3x16	

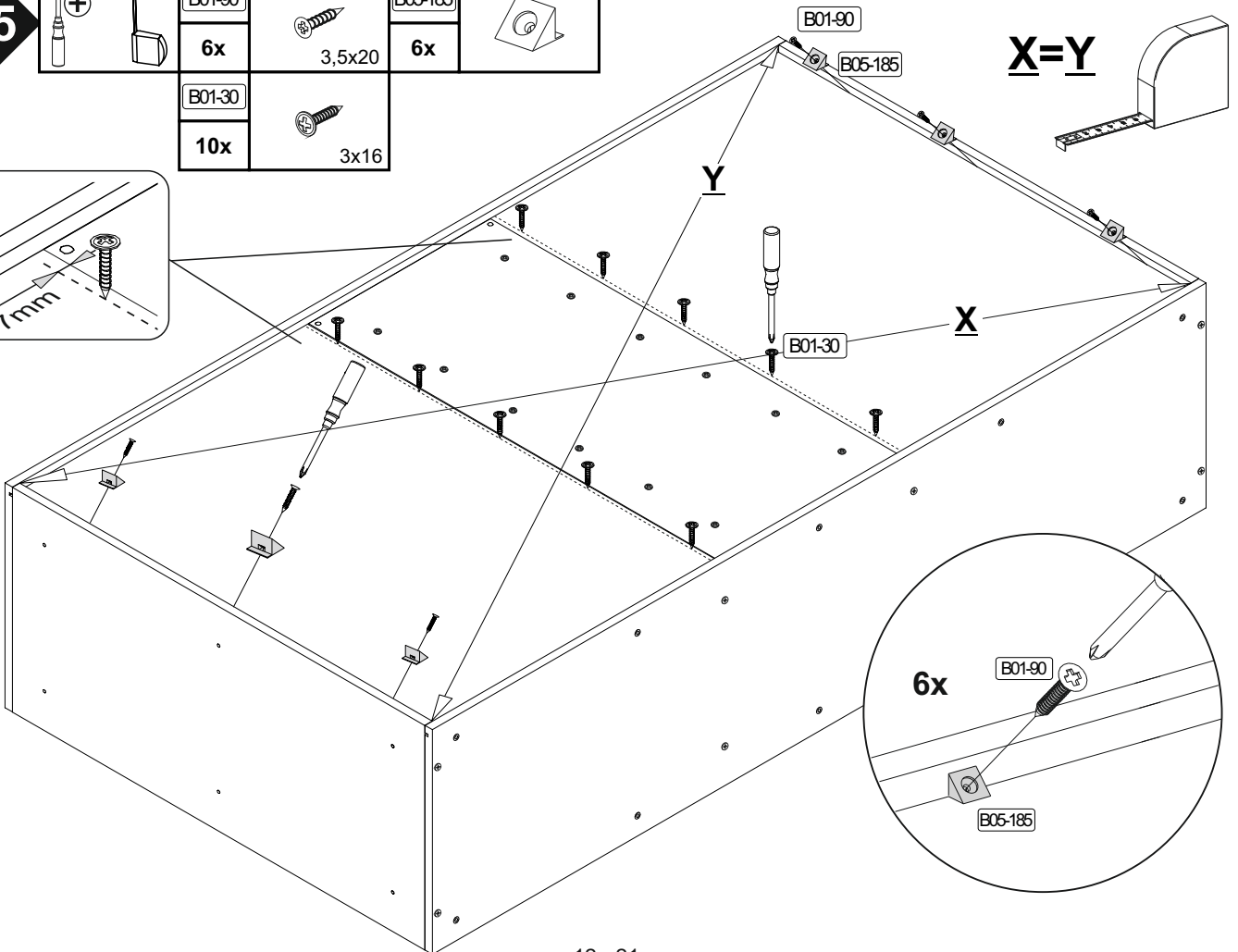
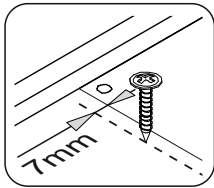



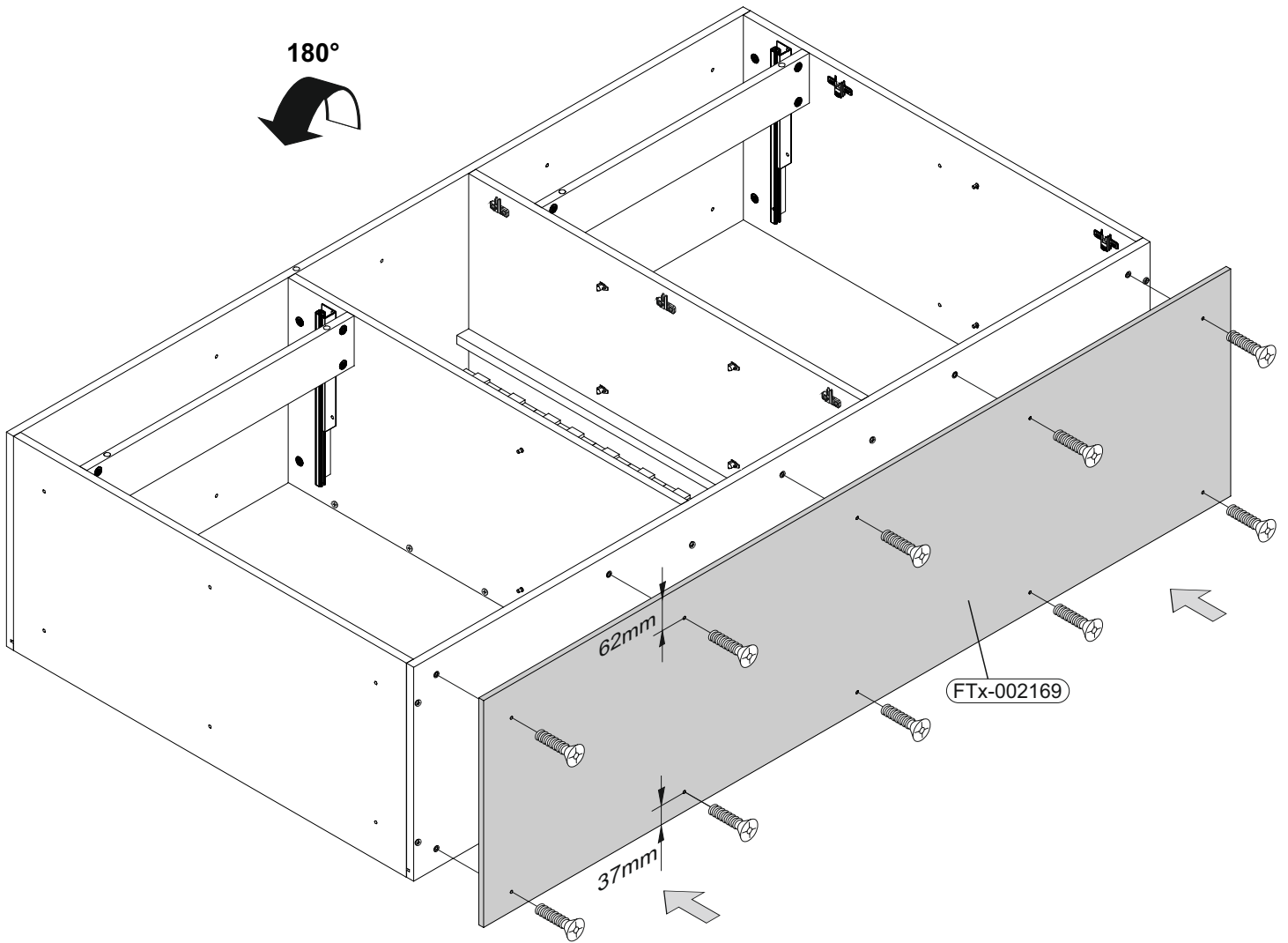

16

	B01-190	
	10x	M4x20



17

		 8x	 16x	 4,0x15
--	--	--	---	--

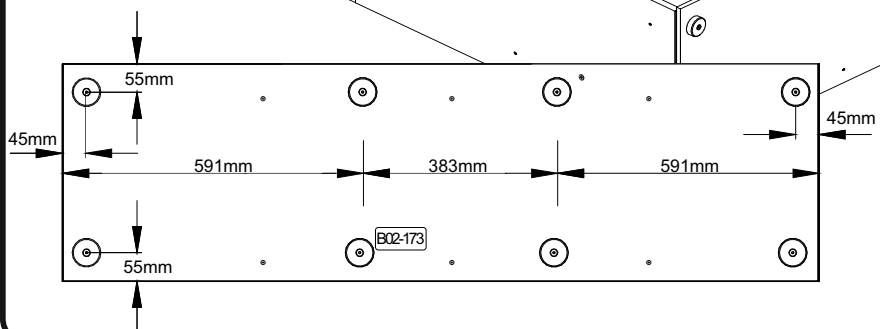
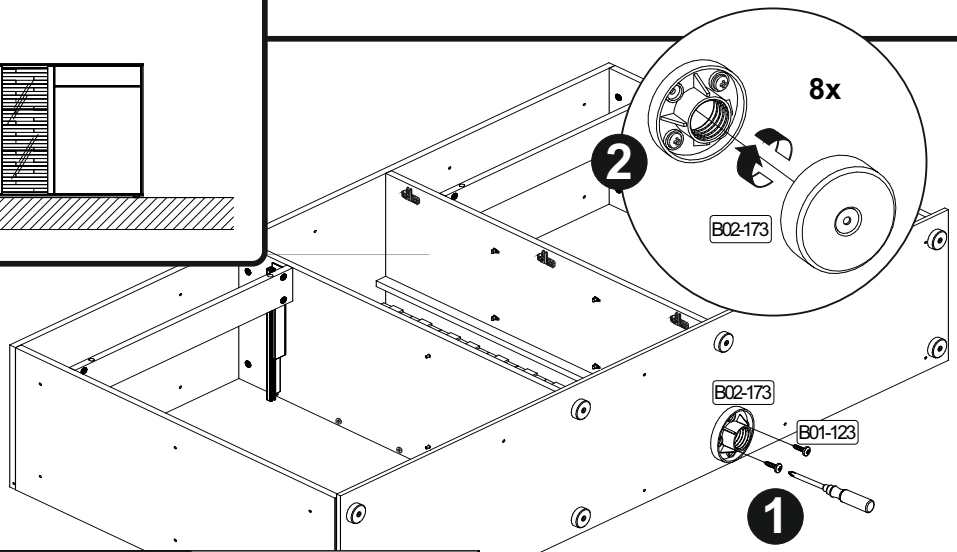
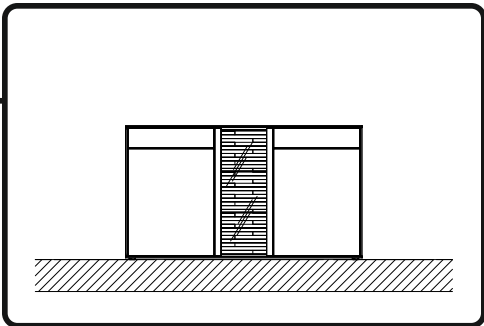
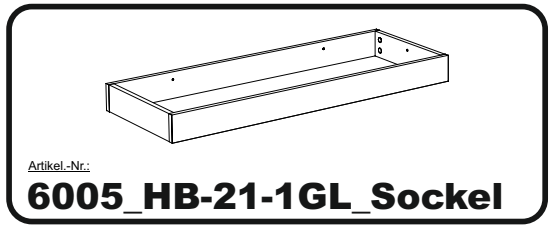
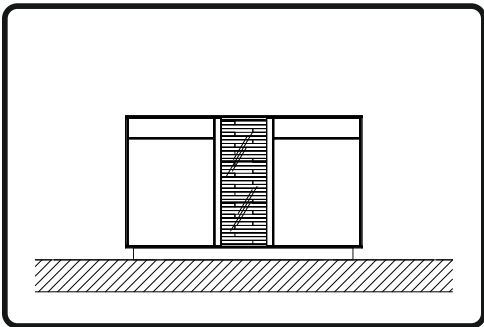
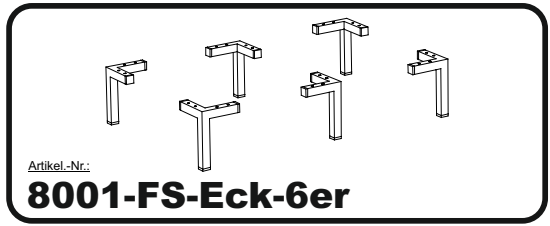
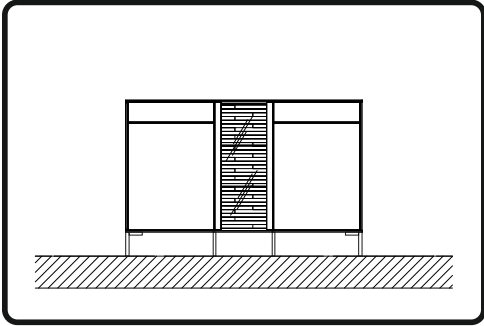
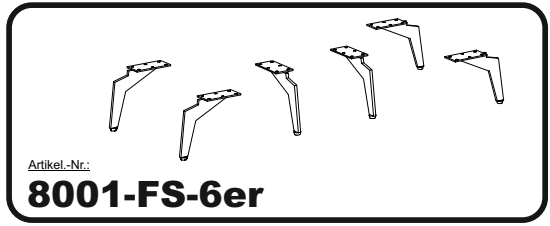
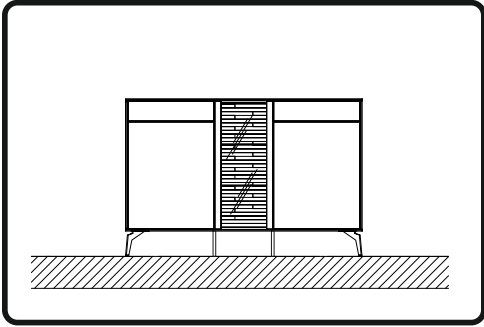

18

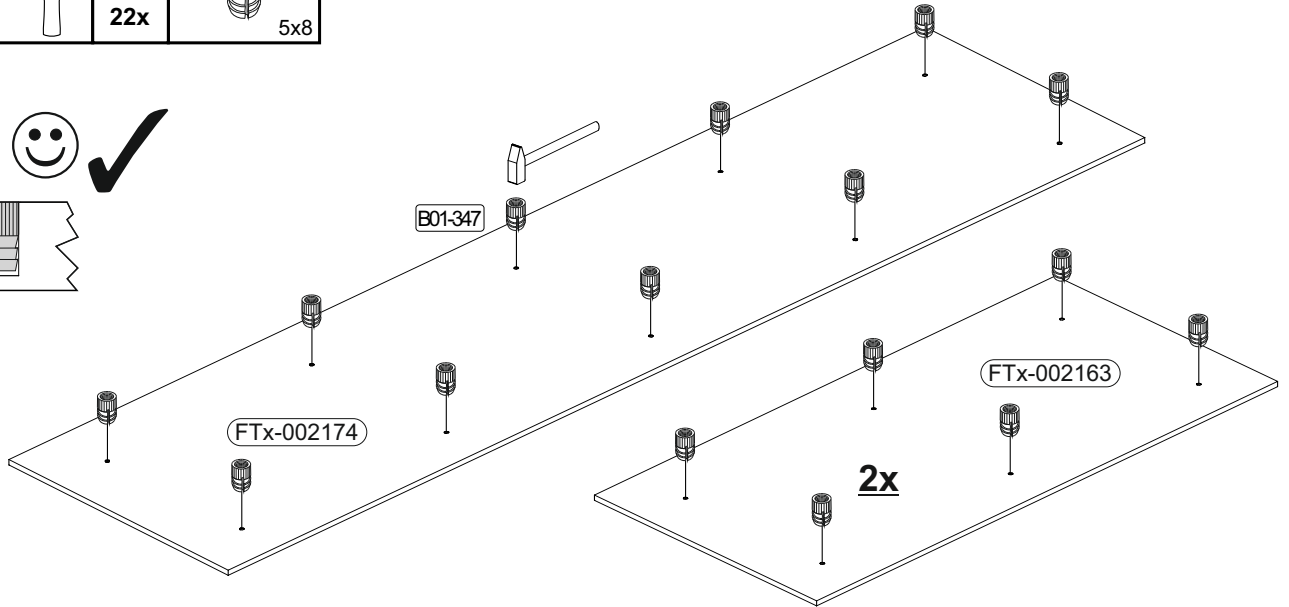
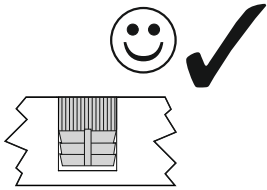
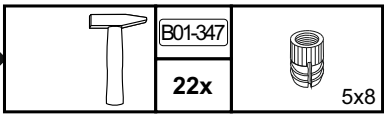

19

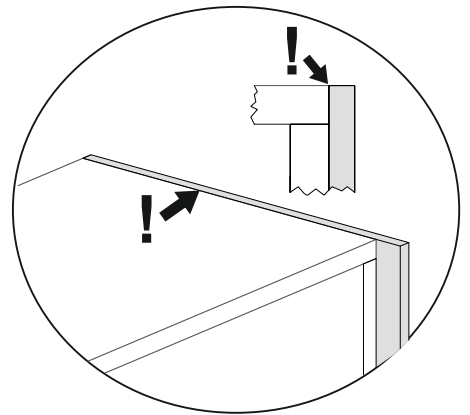
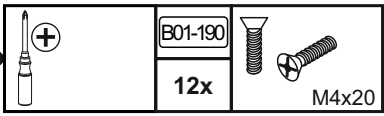

1

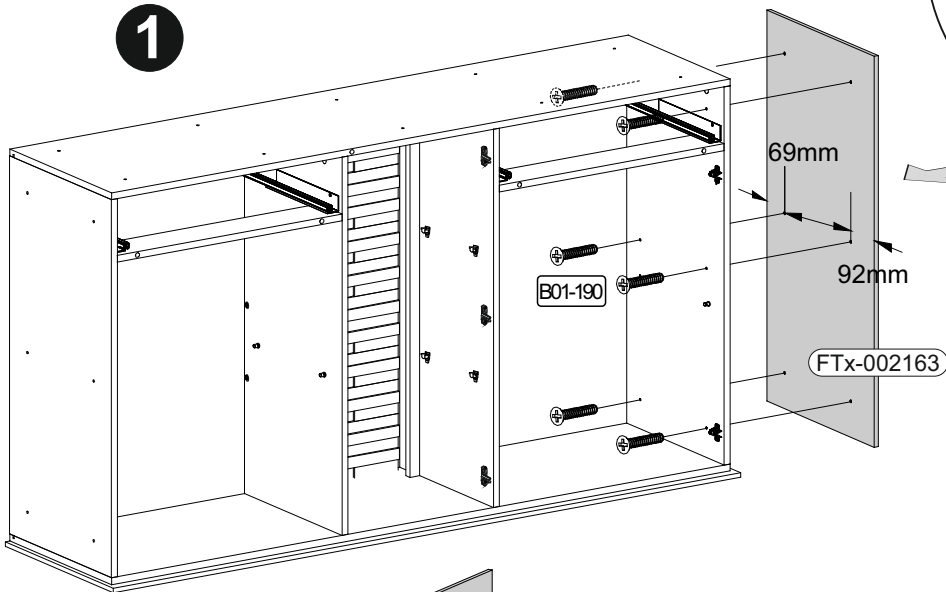

2

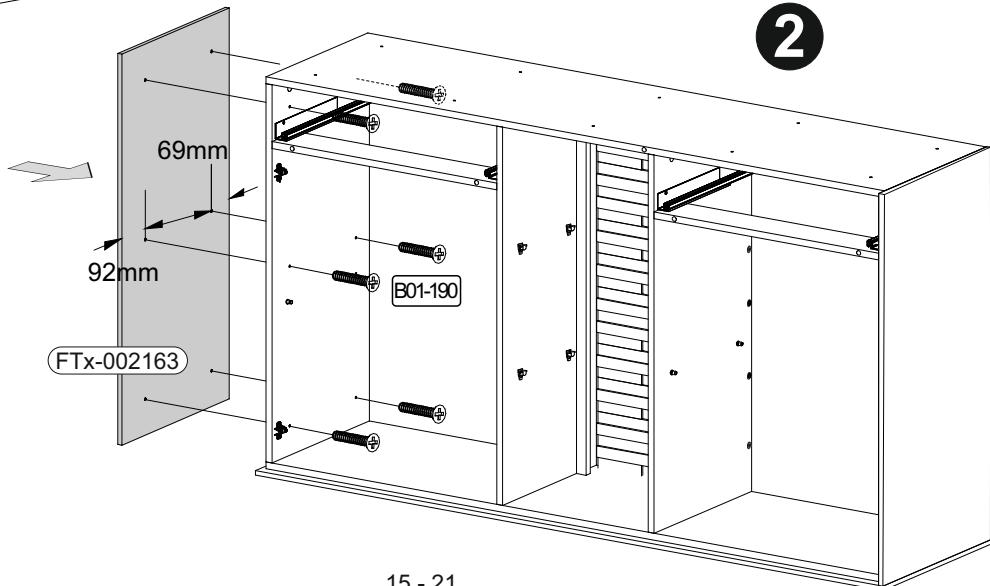

20

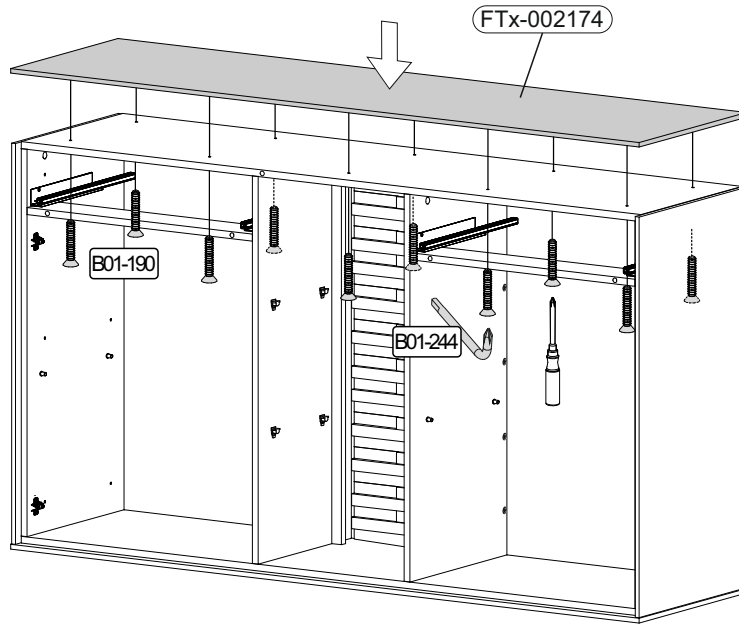
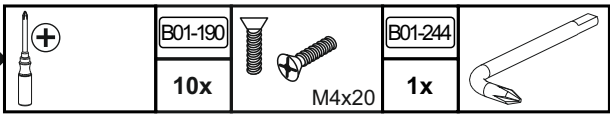

21

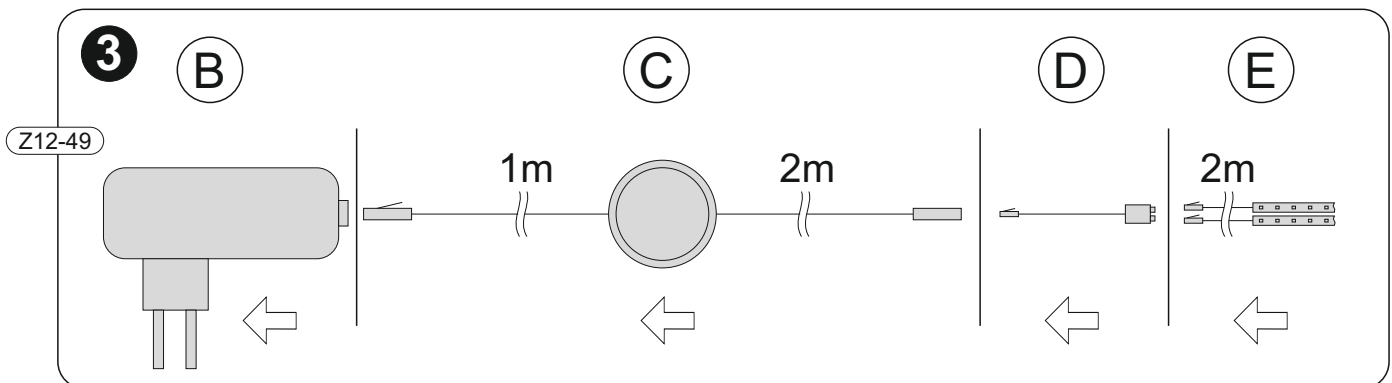
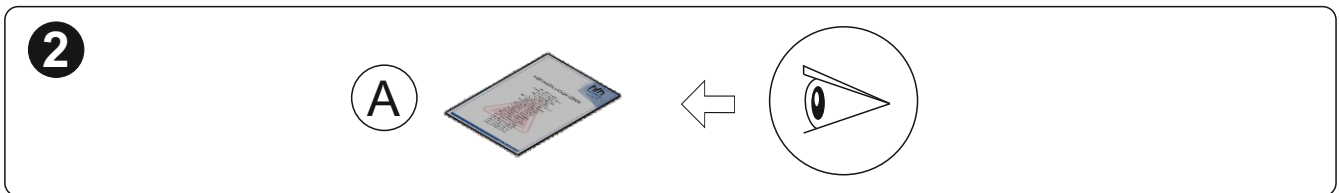
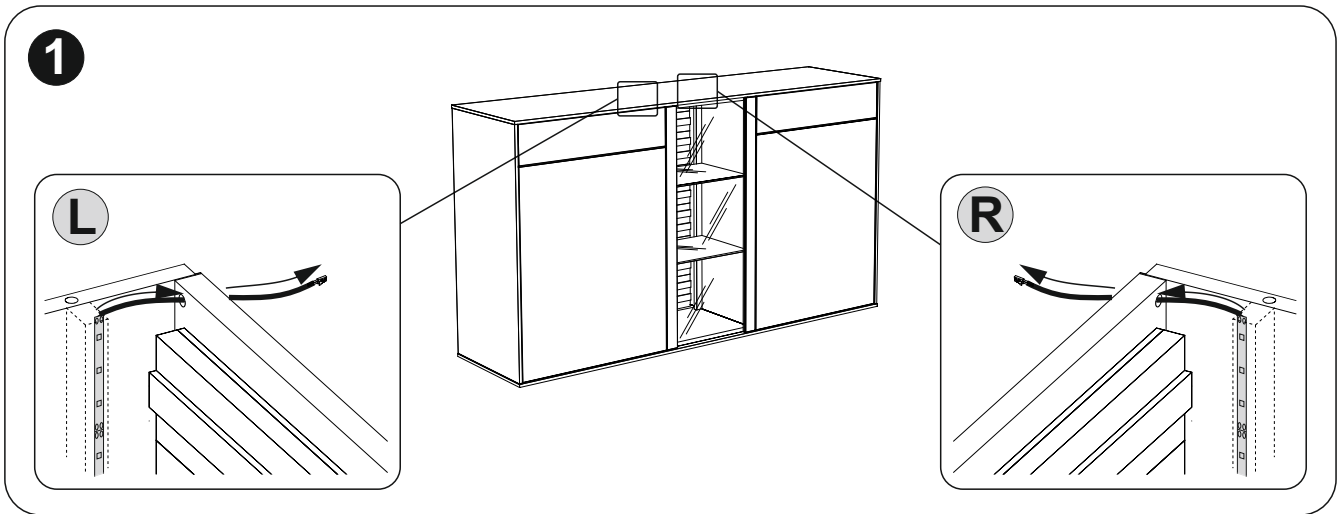

22

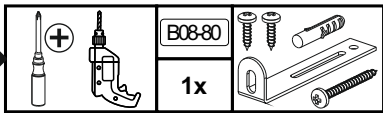

1

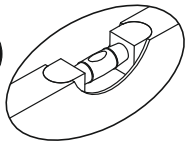

3

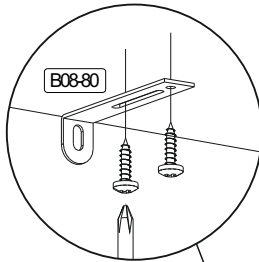

4

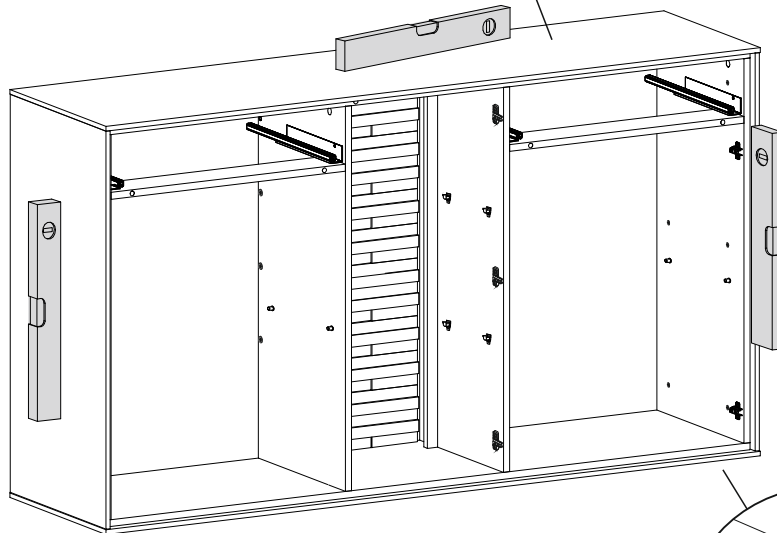
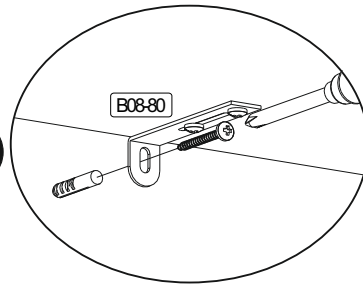



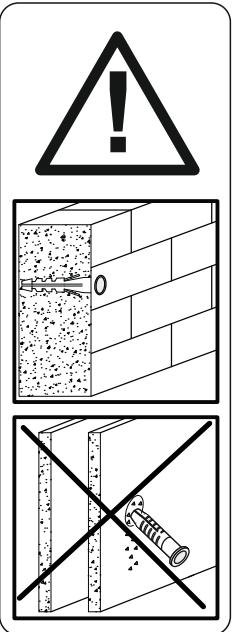
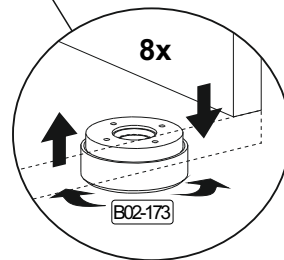



2



Achtung • Attention • Attenzione • Opgelet • Uwaga • Pozor • Figyelem • Atenție • Dikkat • Внимание • Fara • Vaara • Fare • Peligro	
(D)	Wandbefestigung dient als Kippschutz - unbedingt anbringen! Bei einigen Wandtypen kann ein Spezialdübel erforderlich sein!
(GB)	The wall fastening serves to prevent tipping - be absolutely sure to mount it! For certain wall types, a special wall plug may be necessary!
(FR)	La fixation murale sert de protection contre le basculement – à installer impérativement ! Pour certains types de murs il faut des chevilles spéciales !
(TR)	Duvardaki sabitleme, devrilmeye karşı bir emniyet tedbiridir ve mutlaka monte edilmelidir! Bazı duvar tiplerinde bunun için özel bir dübel gerekli olabilir!
(IT)	Il fissaggio alla parete serve da protezione anti-ribaltamento – attaccarla assolutamente! Per alcune strutture di parete può essere necessario un tassello speciale!
(NL)	Bevestiging aan de muur dient als kantelbescherming – zeker en vast bevestigen! Bij enkele muurtypes is een speciale plug misschien vereist!
(RU)	Обязательно установите крепление на стене во избежание опрокидывания! Для некоторых типов стен может потребоваться специальный дюбель!
(CZ)	Montáž na stěnu slouží jako ochrana proti převrnutí – bezpodmínečně umístěte! U některých typů stěn může být zapotřebí speciální hmoždinka!
(HU)	A terméket a falhoz kel rögzíténi, különben az felborulhat! Egyes faltípusoknál speciális tiplít kell használni!
(RO)	Sistemul de fixare la perete serve ca protecție la răsturnare - de montat obligatoriu! Pentru unele tipuri de pereți este posibil să fie necesar un diblu special!
(PL)	Mocowanie do ściany jest jednocześnie zabezpieczeniem przed przewróceniem – koniecznie zamontować! Do niektórych rodzajów ścian koniecznie zastosować specjalne kołki mocujące.
(SWE)	Väggmontering fungerar som anti-lutningskydd - det är viktigt att fästa det! En speciell plugg kan behövas för vissa väggtyper!
(FIN)	Seinäkiinnitys toimii kaatumista estävänä suojana - se on ehdottomasti kiinnitettävä! Joihinkin seinätyyppeihin voidaan tarvita erityistappi!
(NOR)	Veggmontering fungerer som anti-vippebeskyttelse - det er viktig å feste det! En spesiell dyvel kan være nødvendig for noen veggtyper!
(DAN)	Vægmontering fungerer som anti-vip beskyttelse - det er vigtigt at fastgøre det! En speciel dyvel kan være påkrævet til nogle vægtyper!
(SK)	Upevnenie na stenu slúži ako ochrana proti prevráteniu – bezpodmienečne použite! Pre niektoré druhy stien môže byť potrebná špeciálna hmoždinka!
(ES)	El montaje en la pared sirve como protección antivuelco: ¡es imprescindible fijarlo! ¡Es posible que se requiera una espiga especial para algunos tipos de paredes!

23

		B02-10		B02-20		B02-103		B01-30	
		8x	$\varnothing 15 \times 12 \text{ mm}$	8x	16x		8x30	10x	3x16

1

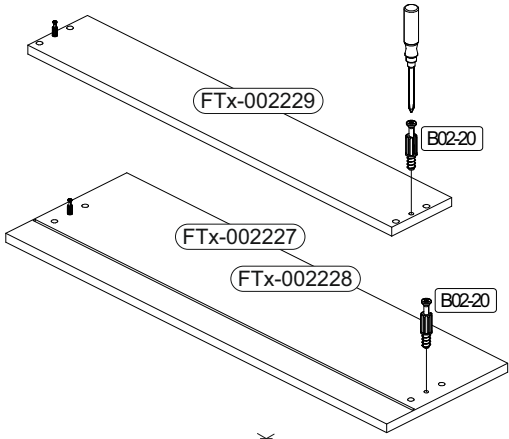

2

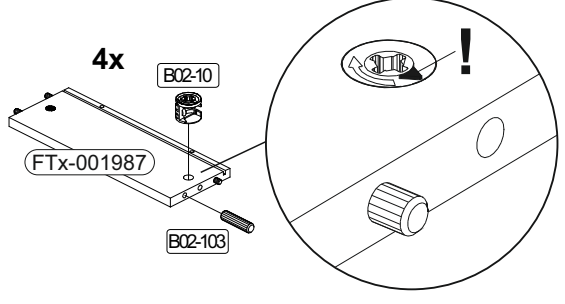

3

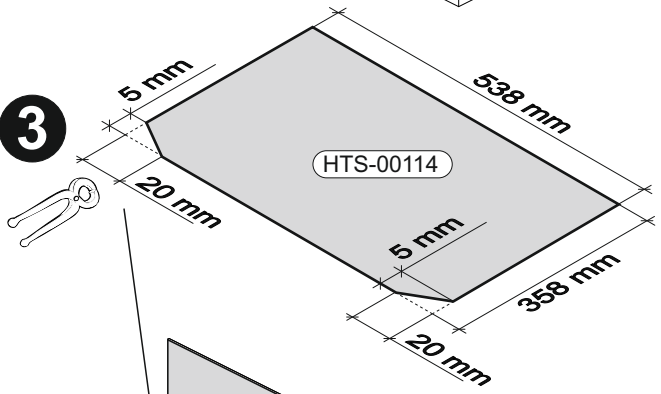

4

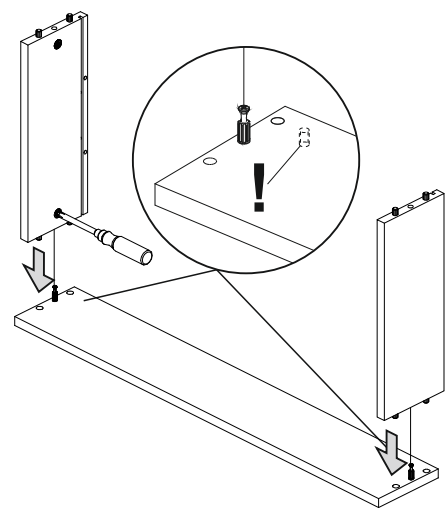

5

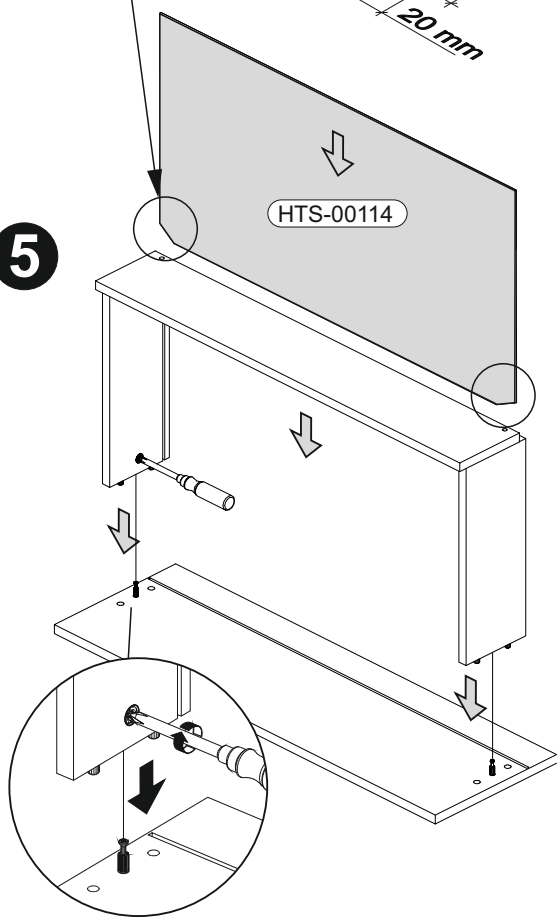

6

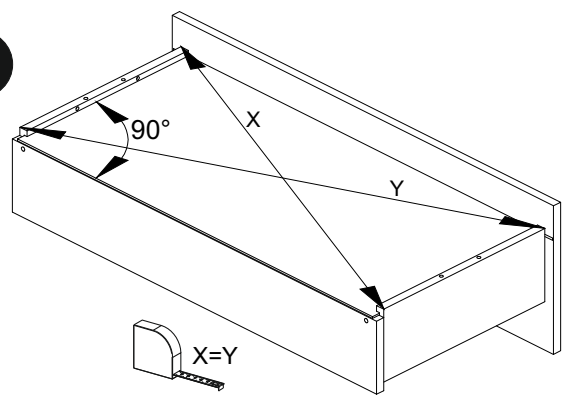

7

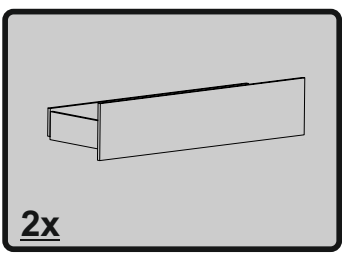
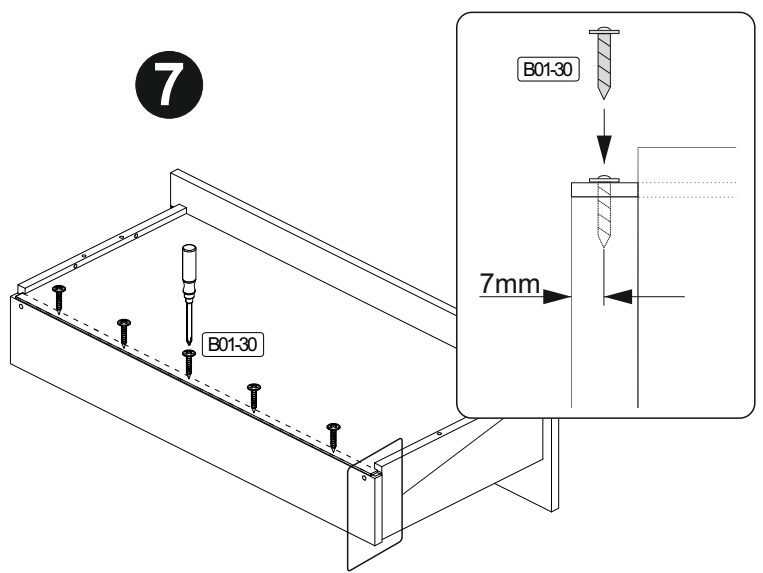

24

	B05-300	
	4x	

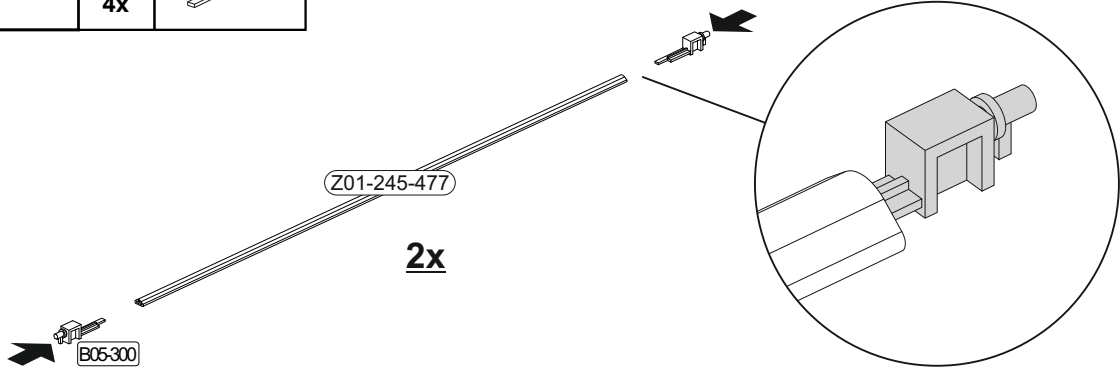

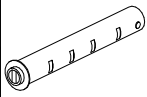

25

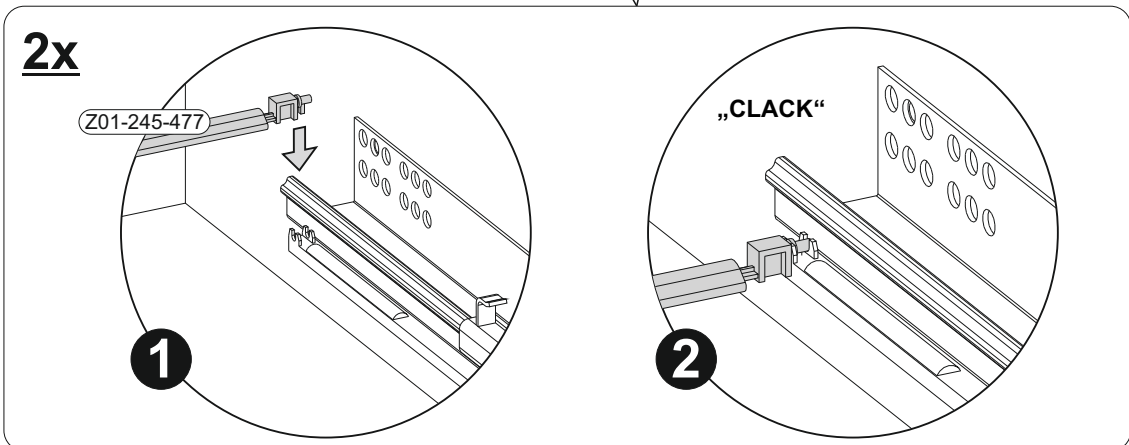
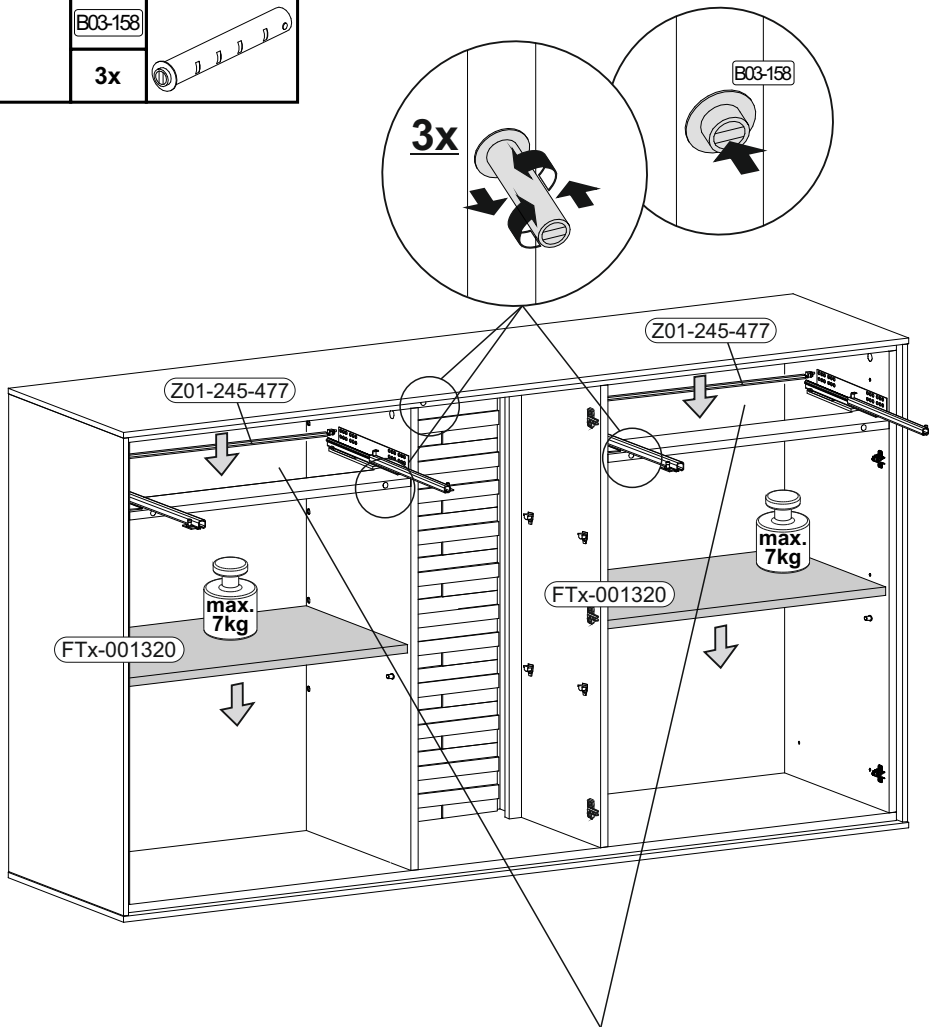
	B03-158	
	3x	

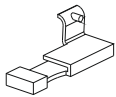
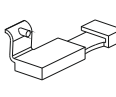

26

	B05-301		B05-302		B05-20	
	2x		2x		8x	

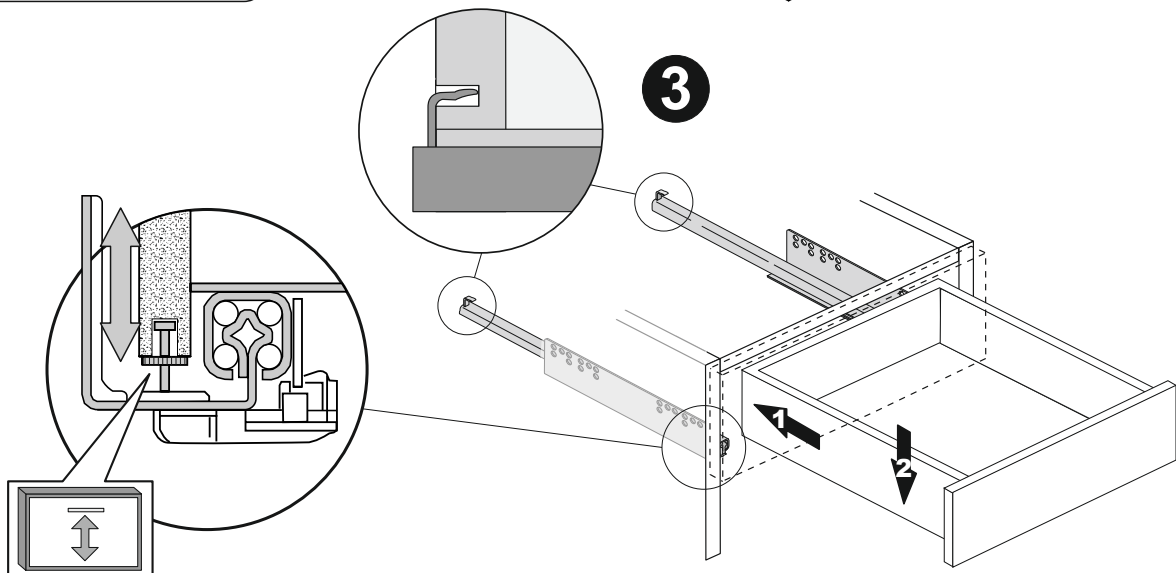
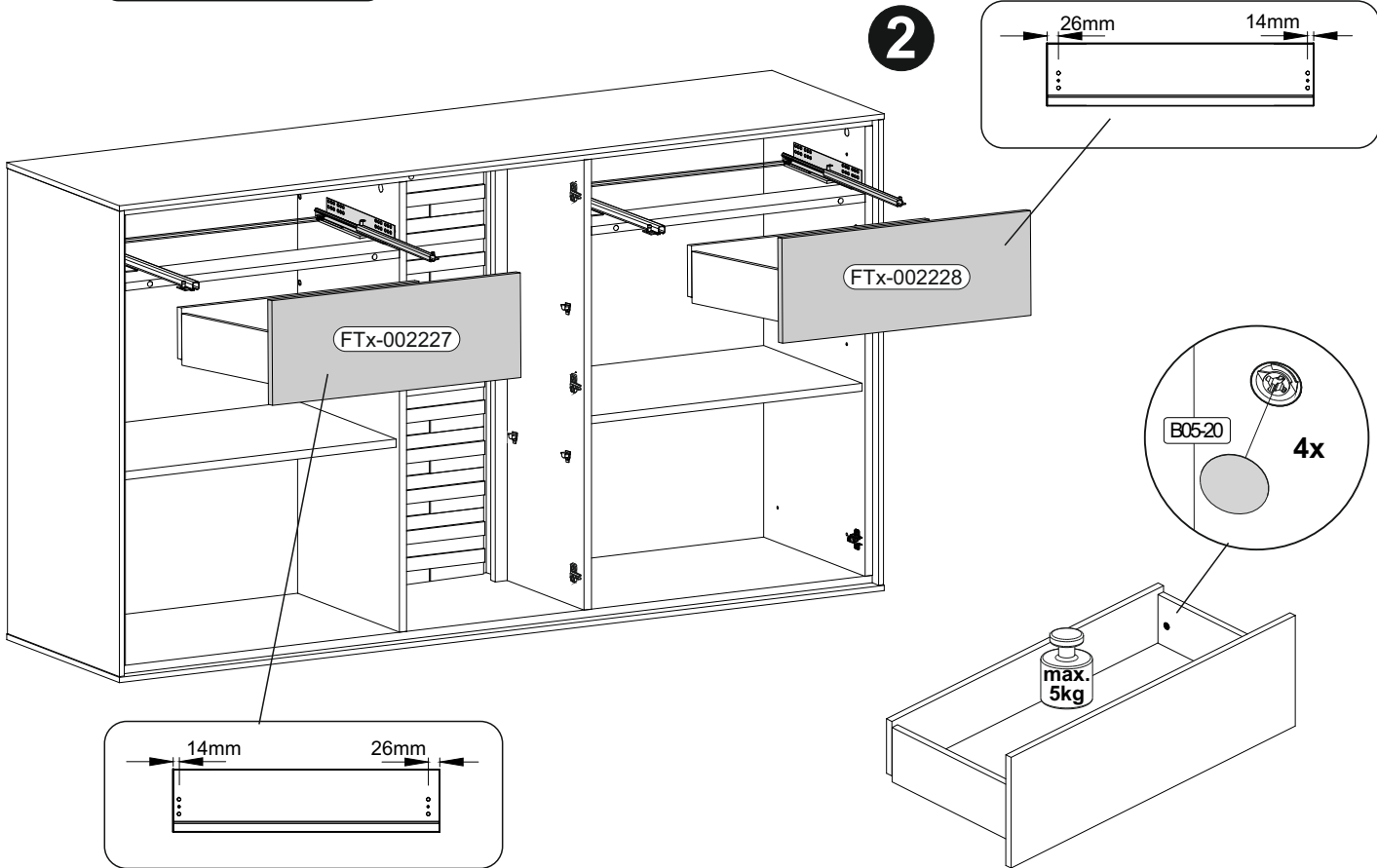
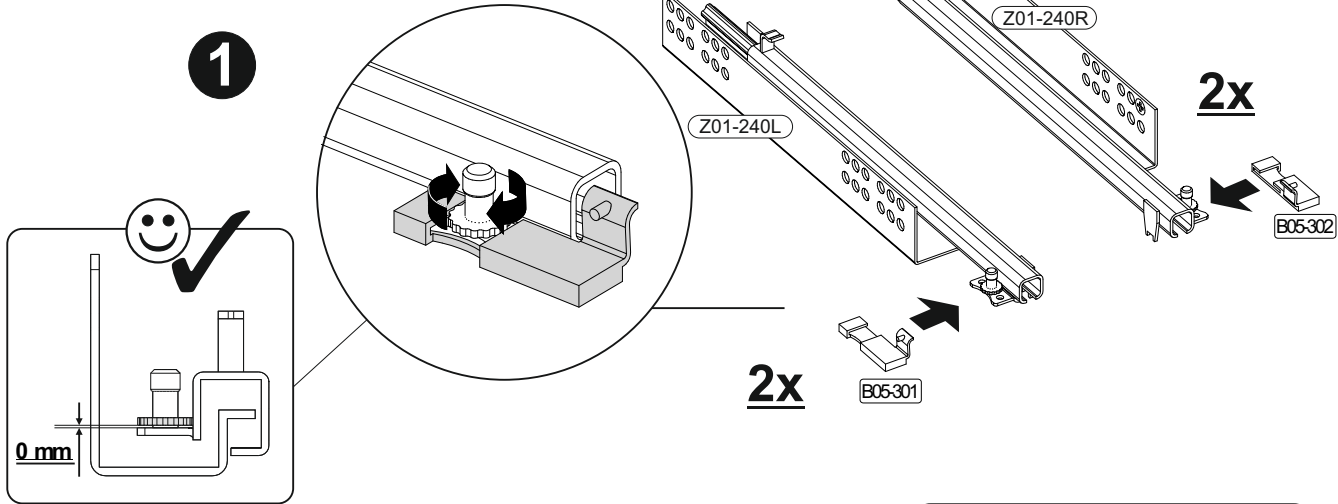

27

	B03-40		B03-41		B01-80		B03-131		B05-01			ø14mm
	3x		4x		8x	3,5x13	4x		2x			

