

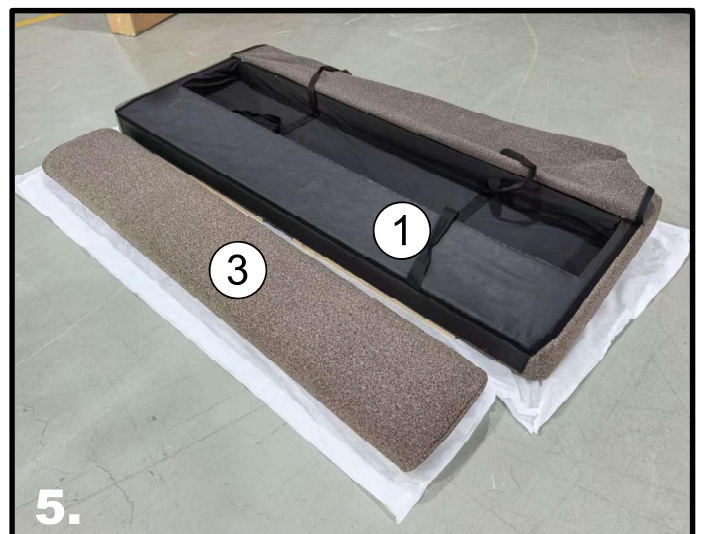

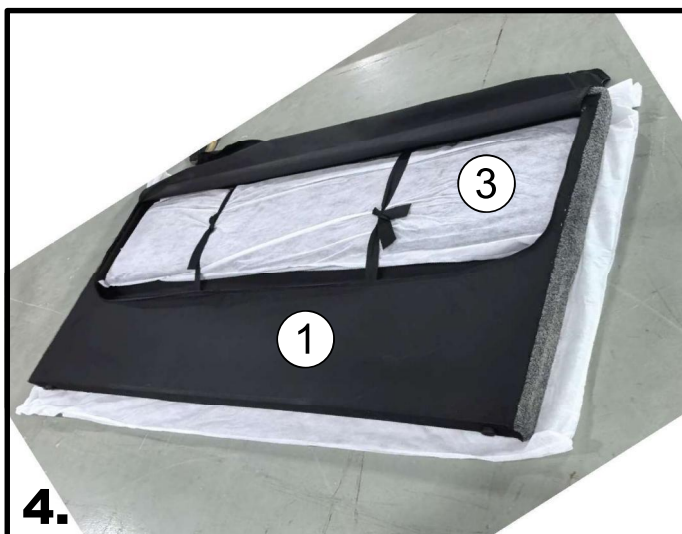

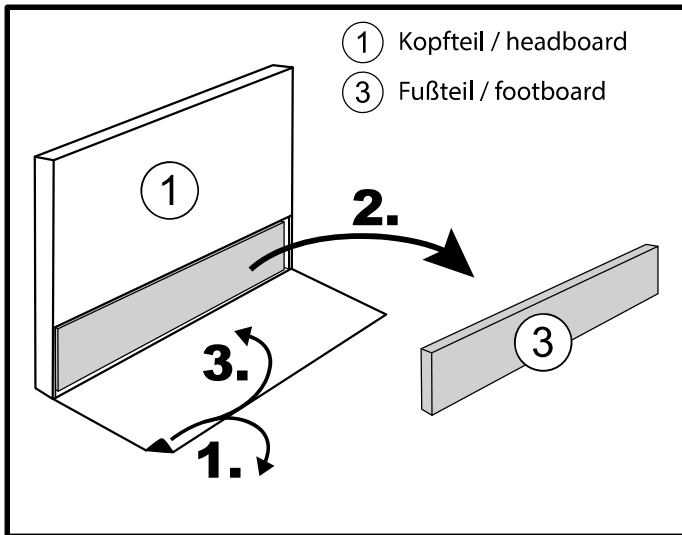

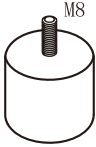

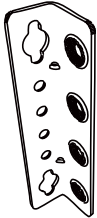
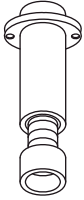
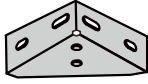
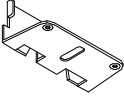

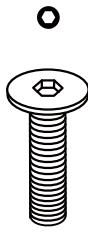
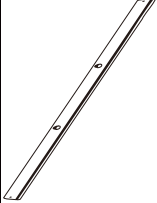
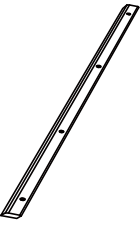
## Fußteil im Kopfteil Footboard inside of the headboard

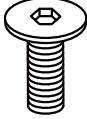

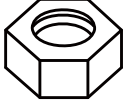
# Tessin by meise(JF8032)

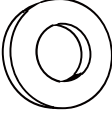
160cm  
180cm

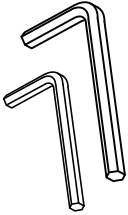
A-108	B-108	C-108	D-108	E-108	F-108	G-108	H-108	I-108
2	4	2	4	2	4	8	1	2
		 ca. 130-200						
H50	-		-	-	M4*20	M8*60	1990*70*20	1520*36*36
J-108	K-108	L-108	M-108	N-108	O-108	P-108	Q-108	
16	16	2	2	1	2	1	1/1	
								
M6*30	M8*30	M6*20	M8	Set	M8	M13	4/5	

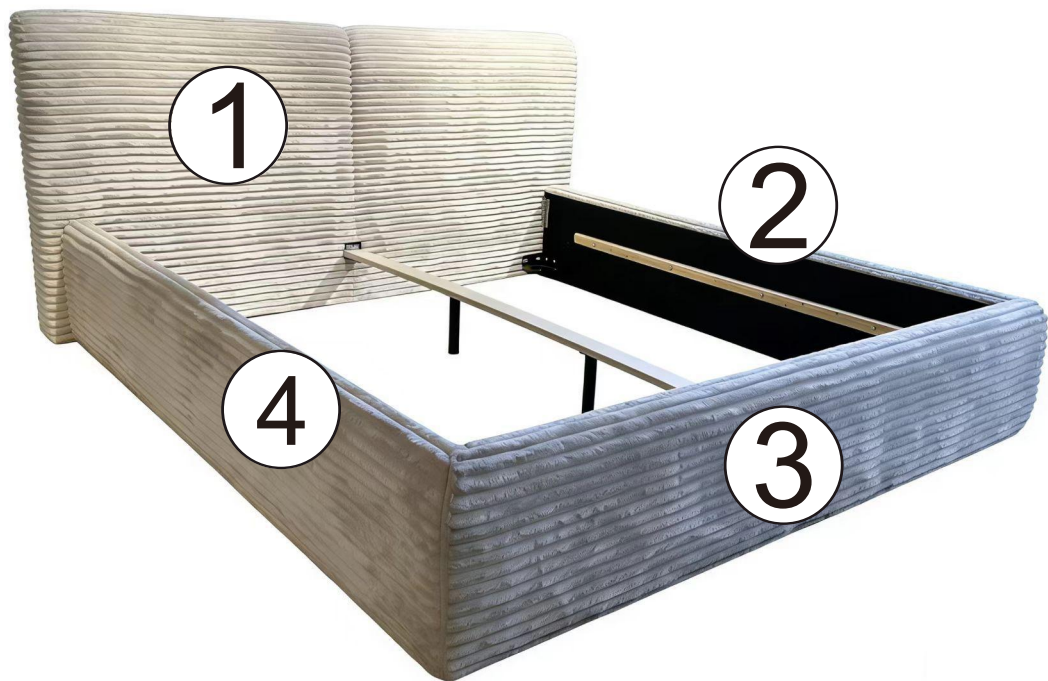

		 30 min						
---	---	---	---	---	--	--	--	--



**2**

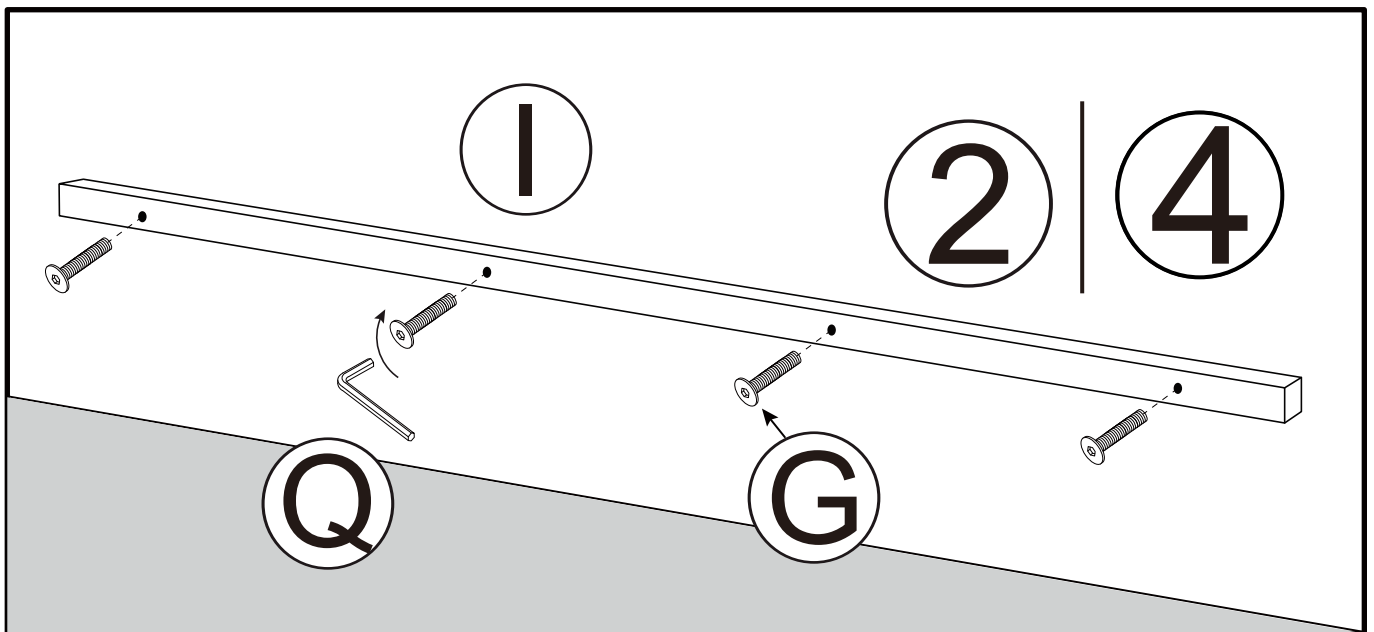
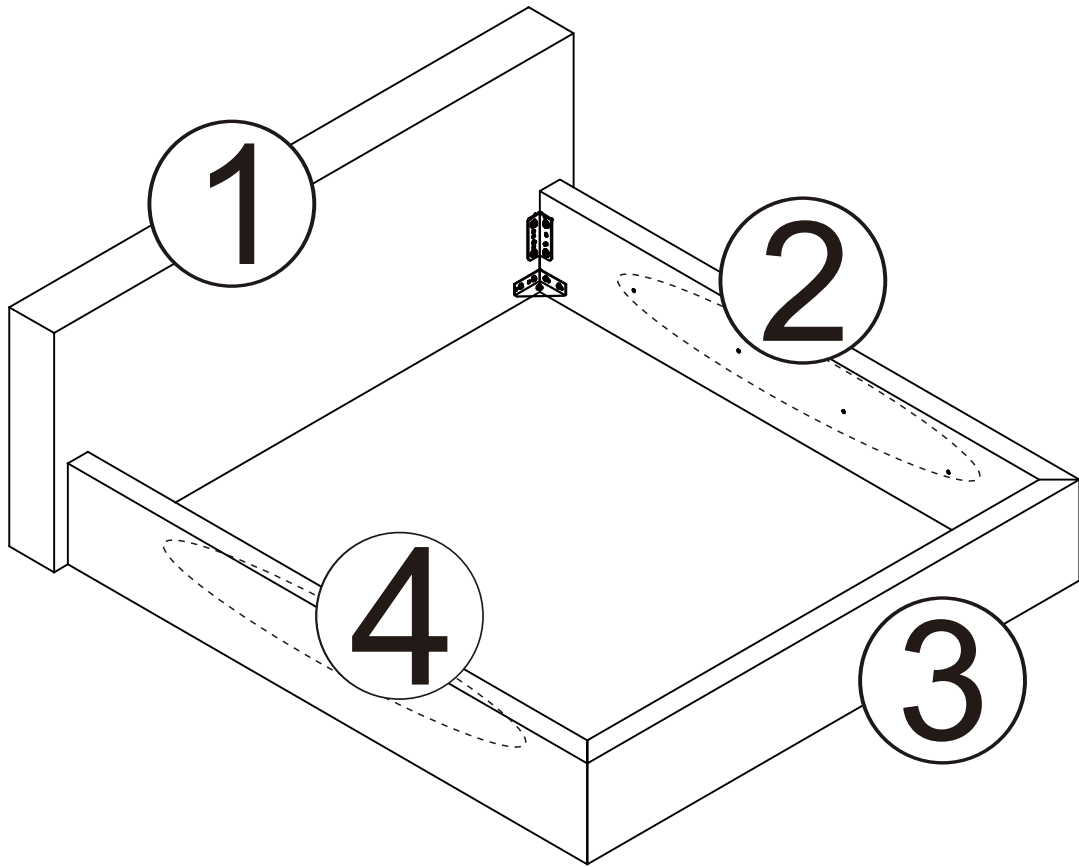

**3**

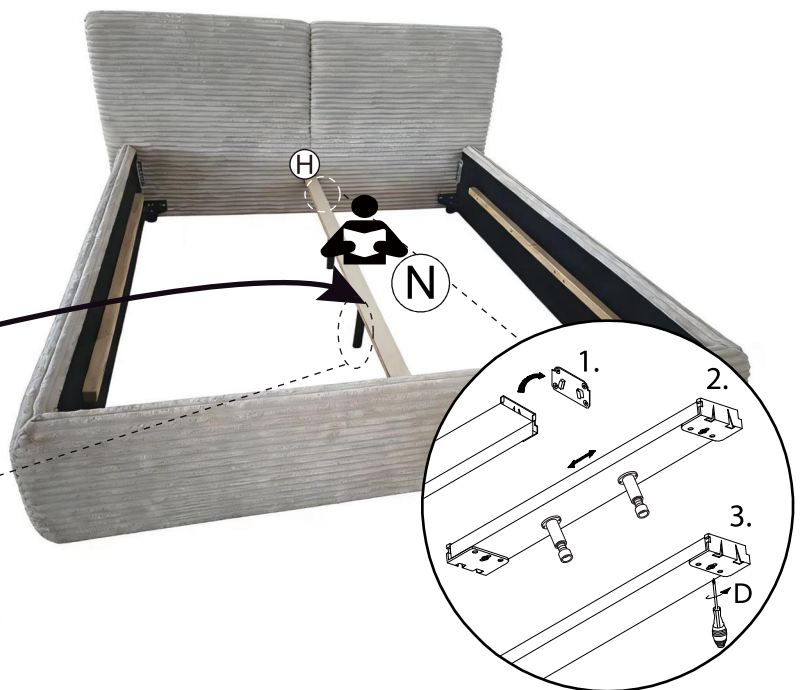
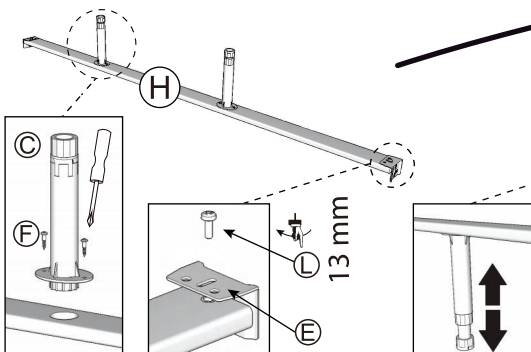
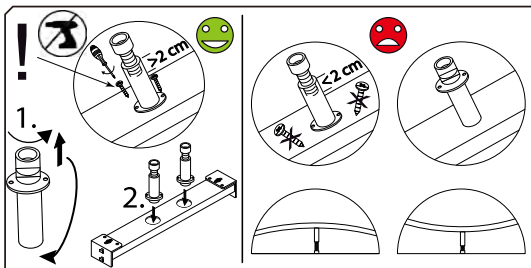
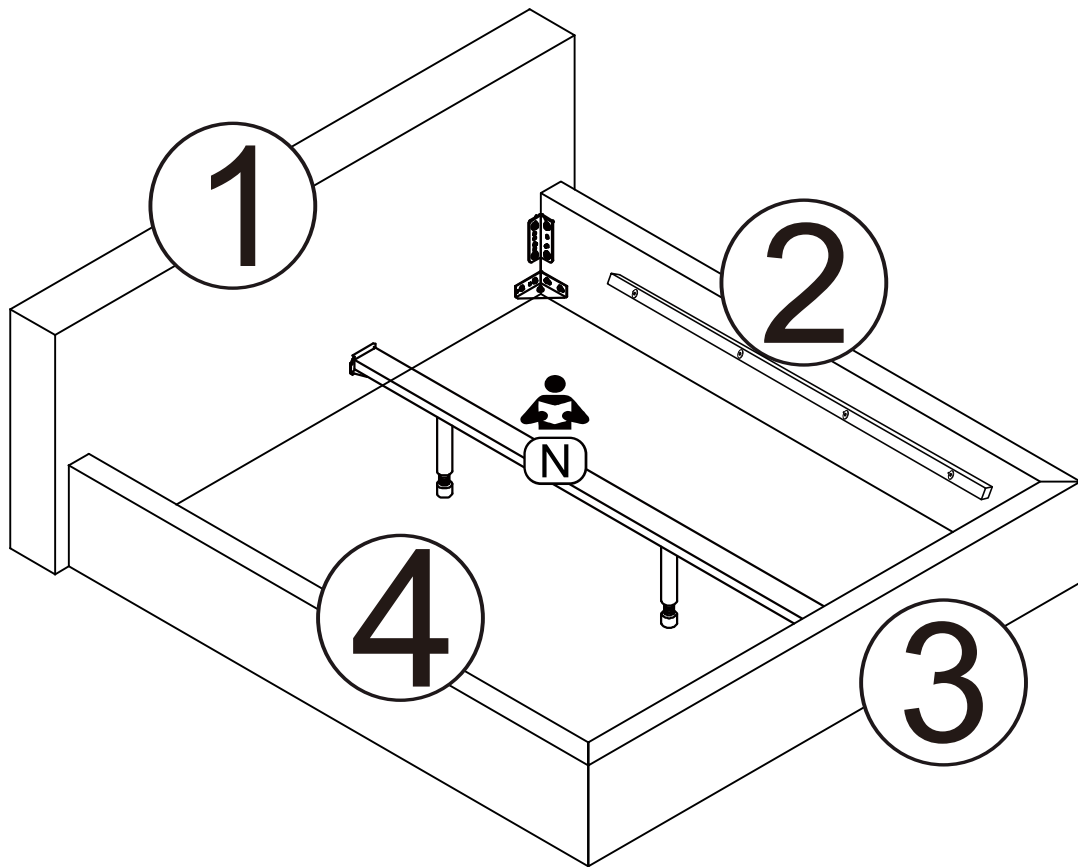

# SPACER

160 cm  
 180 cm  
 200 cm

-	A-86	B-86						
1 Set ->	4	4						
					 10 min			
1-Set	10*35	4*50						

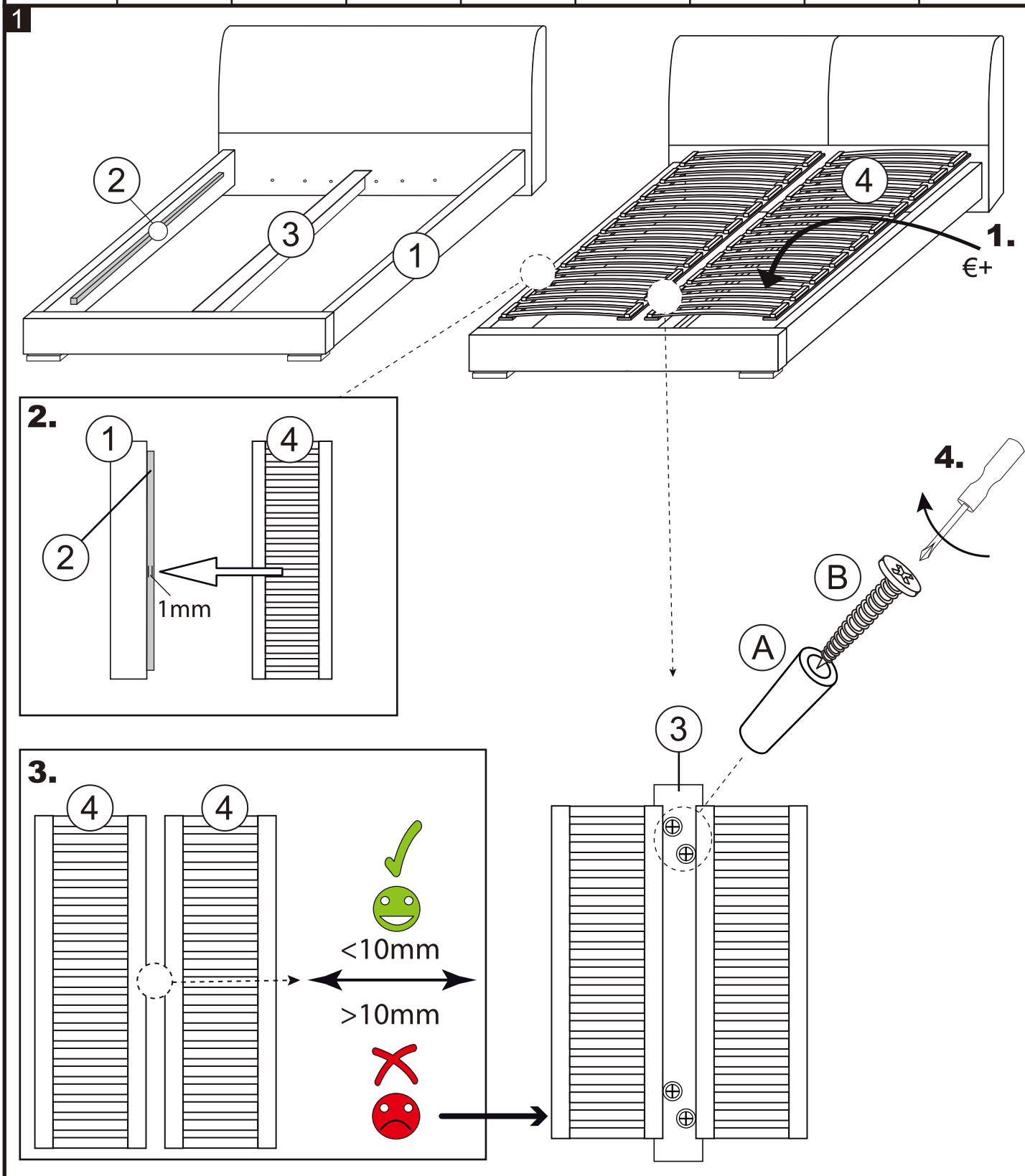



„Wichtig: Gebrauchs- und Montageanleitung für spätere Bezugnahme aufbewahren, sorgfältig lesen“

"Important: for future reference please keep the assembly instruction, read it carefully"

„Important : Notice d'utilisation et de montage pour toute référence ultérieure, à conserver et à lire attentivement.“

**Modelle** mit Lichtquellen: Die Lichtquellen und die separaten Steuerungselemente können zur Überprüfung durch die Marktüberwachungsbehörde / als Austauschteil aus dem umgebenden Produkt entnommen werden, ohne sie dauerhaft zu zerstören.

Anweisungen dazu finden Sie in der technischen Dokumentation des Produktes.

**Models** incl. LED Light: The light sources and the separate control elements can be removed from the surrounded product for inspection by the market surveillance authority / as replacement part without permanently destroying them. Instructions for this can be found in the technical documentation of the product.

**Modèles** avec sources lumineuses : Les sources lumineuses et les éléments de commande séparés peuvent être retirés du produit environnant pour être contrôlés par l'autorité de surveillance du marché / en tant que pièce de rechange sans être détruits de manière permanente. Vous trouverez des instructions à ce sujet dans la documentation technique du produit.

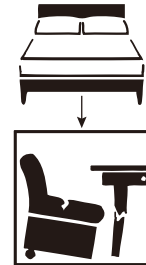
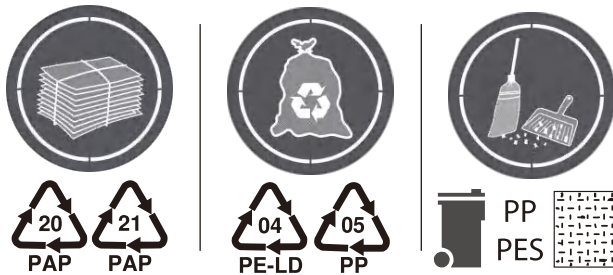
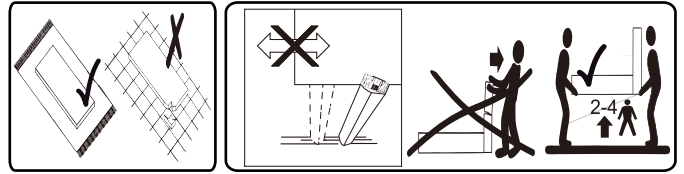
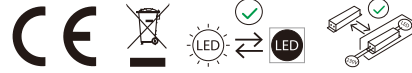

Sperrmüll / bulky waste / Déchets encombrants

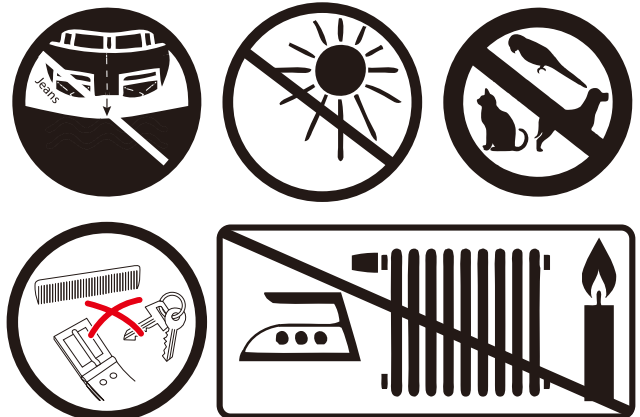
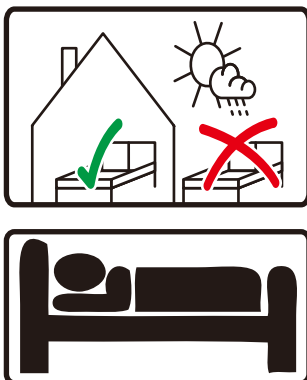
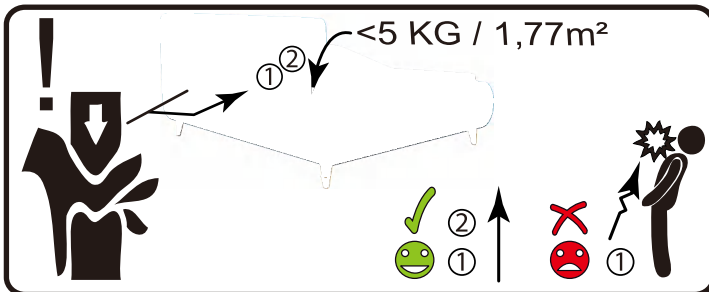

инструкции за монтаж / návod k montáži / monteringsvejledning / instrucciones de montaje / monteerimisjuhendid / instructions de montage / asennusohjeet / οδηγίες συναρμολόγησης / szerelési útmutató / upute za montažu / istruzioni di montaggio / montāžas instrukcijas / surinkimo instrukcijos / montage-instructies / instruções de montagem / instrukcja montażu / instrucțiunile de asamblare / инструкции по сборке / monteringsanvisningar / návod na montáž / navodila za montažo / montaj talimatları