

NOTICE DE MONTAGE
 ASSEMBLING INSTRUCTIONS
 ISTRUZIONI DI MONTAGGIO
 MONTAGEANTEILUNG
 ISTRUÇÕES DE MONTAGEM
 MANUAL DE MONTAJE
 SASTAVLJANJE UPUTE

Lhf

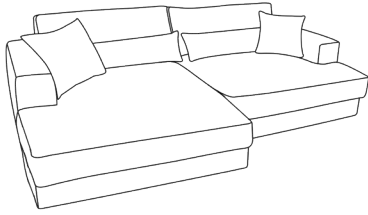

Fabiona

2024/03/19

Rhf

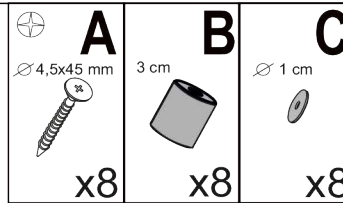
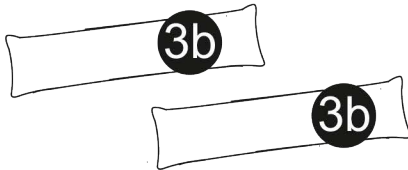
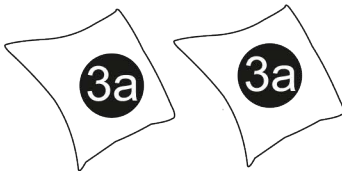
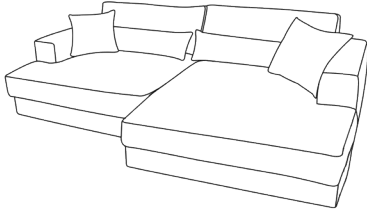

FR AVANT DE COMMENCER, SE REPORTER AUX CONSEILS DE MONTAGE EN ANNEXE

EN BEFORE STARTING REFER TO THE ASSEMBLING ADVICE IN ANNEX

IT AVANTI DI COMMINCIARE RIPORTATE AGLI CONSIGLI DI MONTAGGIO

DE VOR DIE MONTAGE, BITTE BEILIEGENDE ANWEISUNGEN FOLGEN

PT ANTES DE COMERCAR, ADIARSE AOS CONSELHOS DE MONTAGEM EM ANEXO

ES ANTES DE EMPEZAR CONSULTE LOS CONSEJOS PARA EL MONTAJE

HR PRIJE POKRETANJA POZIV NA SAVJET SKUPLJANJA U DODATKU

SRB ПРЕДСТАВЉАЊЕ РЕФЕРАТА НА САВЈЕТНИК ЗА УПОТРЕБУ У АНЕКСУ

Lhf

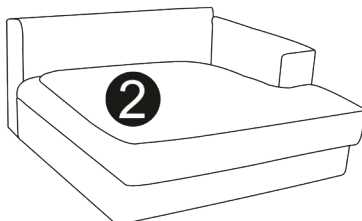
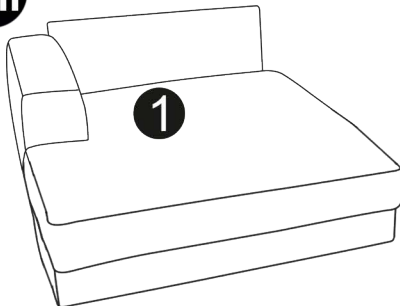

Rhf

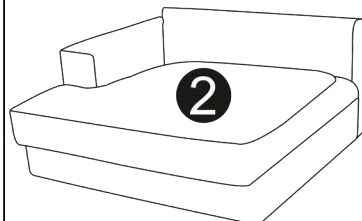
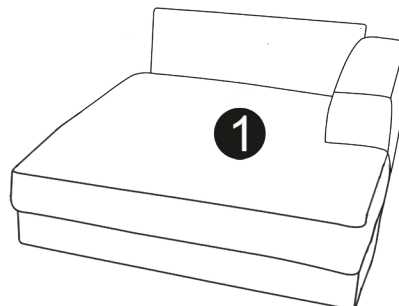

DO NOT REMOVE THE LABEL SAV
 NE PAS ENLEVER L'/TIQUETTE SAV
 NON RIMUOVERE L'ETICHETTA SAV
 SIĘ DAS ETIKETT NICHT ENTFERNEN SAV
 NŕO RETIRE A ETIQUETA SAV
 NO RETIRE LA ETIQUETA SAV
 NEMOJTE UKLANITI LABEL SAV
 НЕ ОТПИСИТЕ ЛАБЕЛ САВ

NOTICE DE MONTAGE
ASSEMBLING INSTRUCTIONS
ISTRUZIONI DI MONTAGGIO
MONTAGEANTEILUNG
ISTRUCOES DE MONTAGEM
MANUAL DE MONTAJE
SASTAVLJANJE UPUTE

I

Lhf

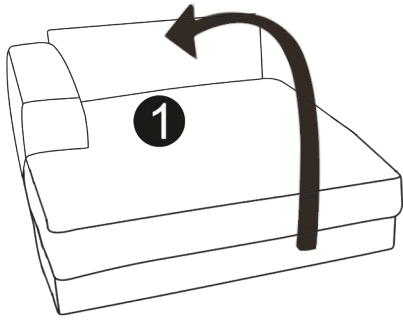

Rhf

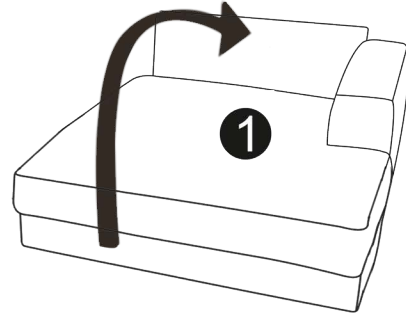

II

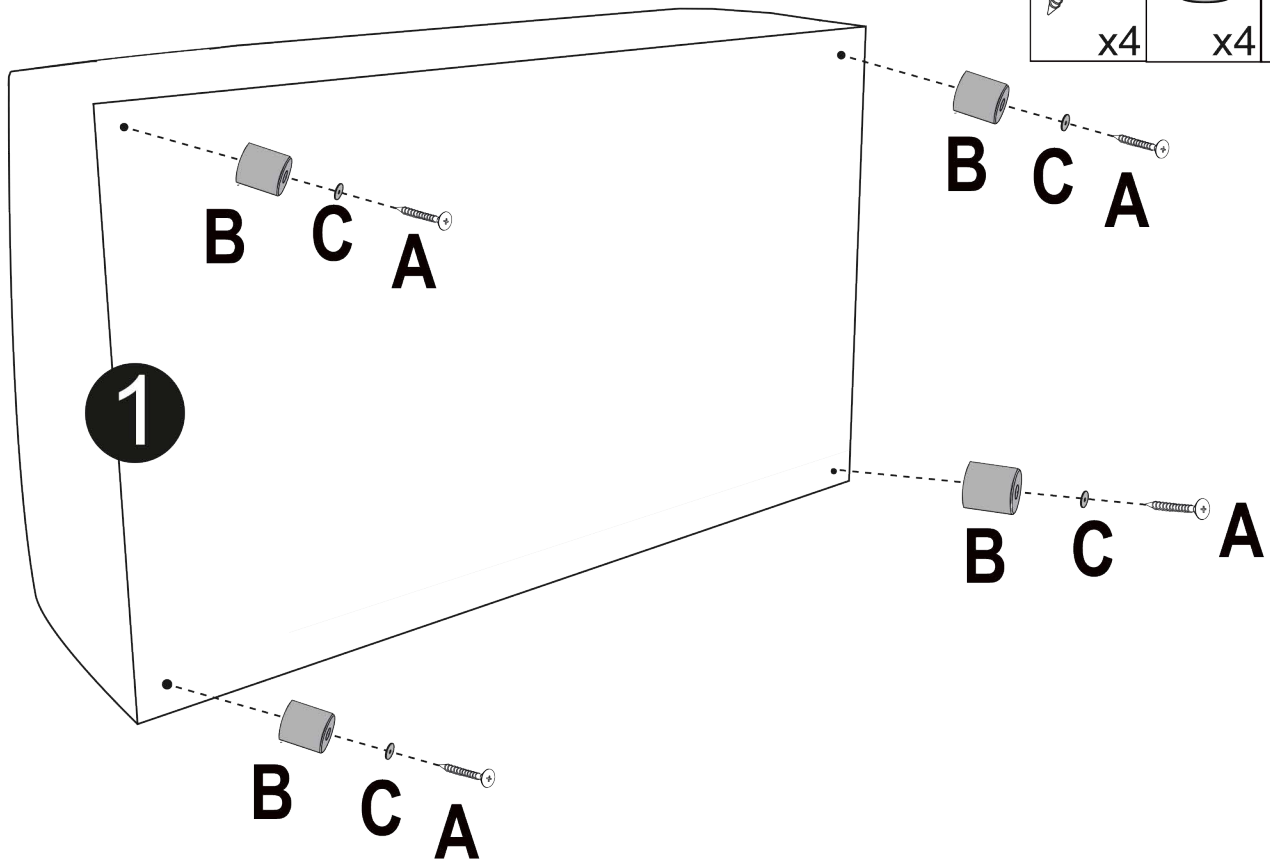

III

Lhf

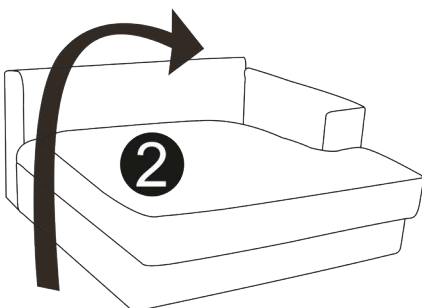

Rhf

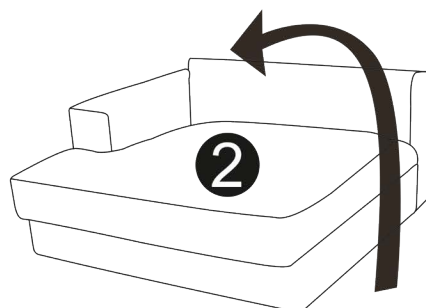

IV

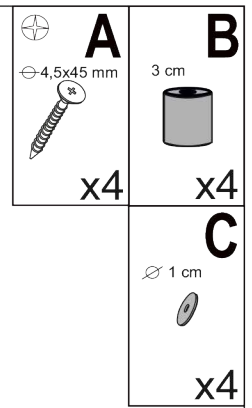
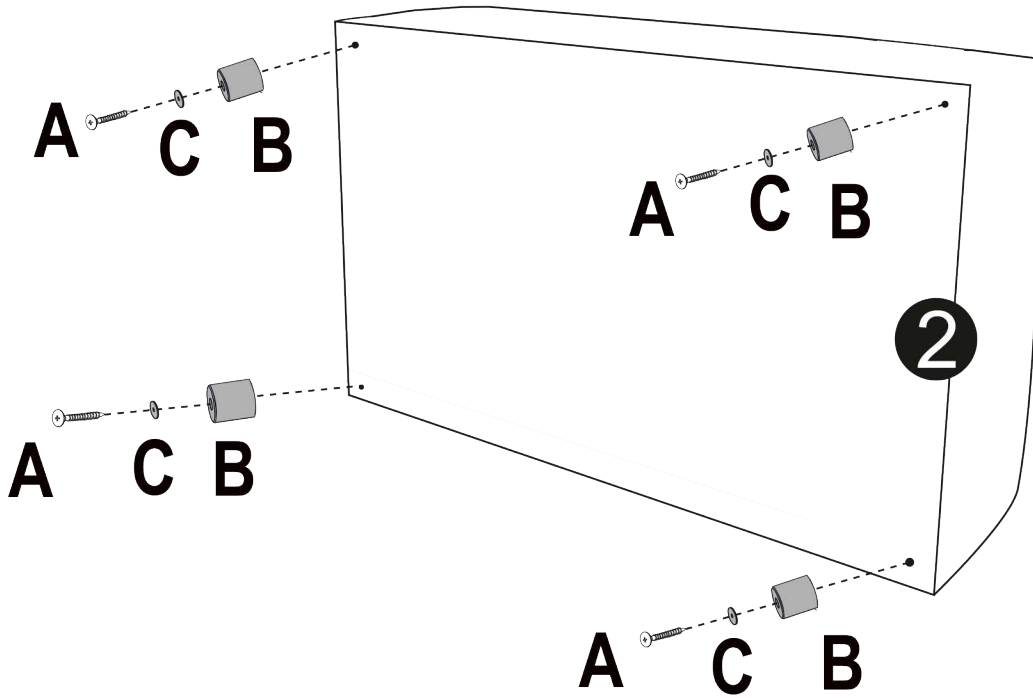

V

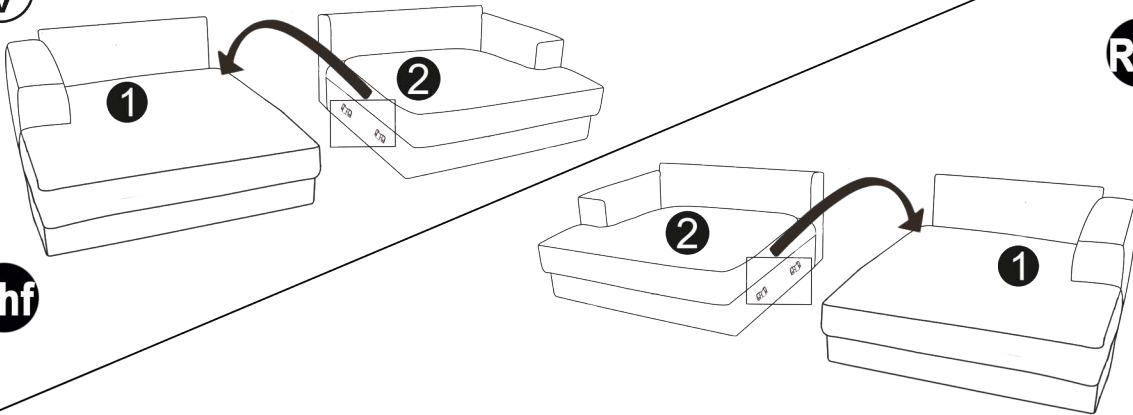

Lhf

Rhf

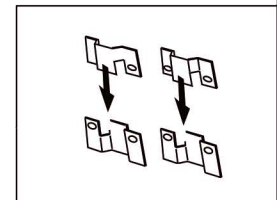

VI

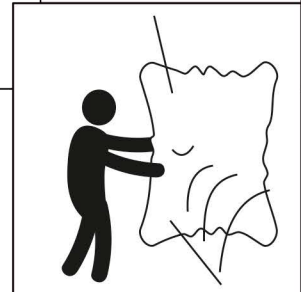
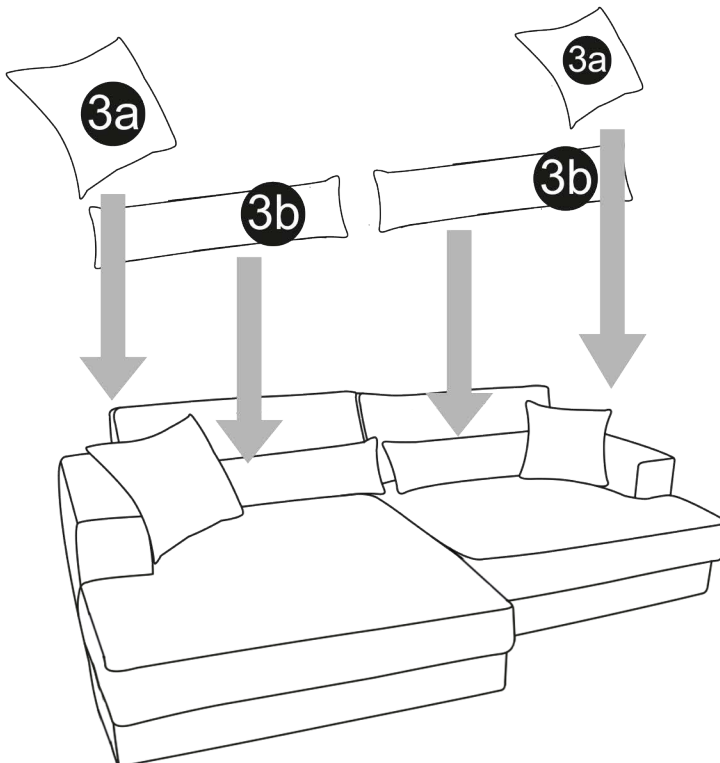

!

UWAGA
Przed ułożeniem poduszek należy nimi mocno wstrząsnąć w celu lepszego ułożenia wkładu wewnątrz poduszki co poprawi jej wygląd.

Attention
Before arranging the pillows, they should be shaken well in order to better arrange the insert inside the pillow, which will improve its appearance

Aufmerksamkeit
Vor dem Anordnen der Kissen sollten sie gut geschüttelt werden, um die Einlage besser im Kissen anzuordnen, wodurch das Aussehen verbessert wird

UWAGA
Poduchy siedziskowe należy co jakiś czas manualnie ukształtować

Attention
Seat cushions should be manually from time to time

Aufmerksamkeit
Sitzkissen sollten sein von Zeit zu Zeit manuell