

07200016/01

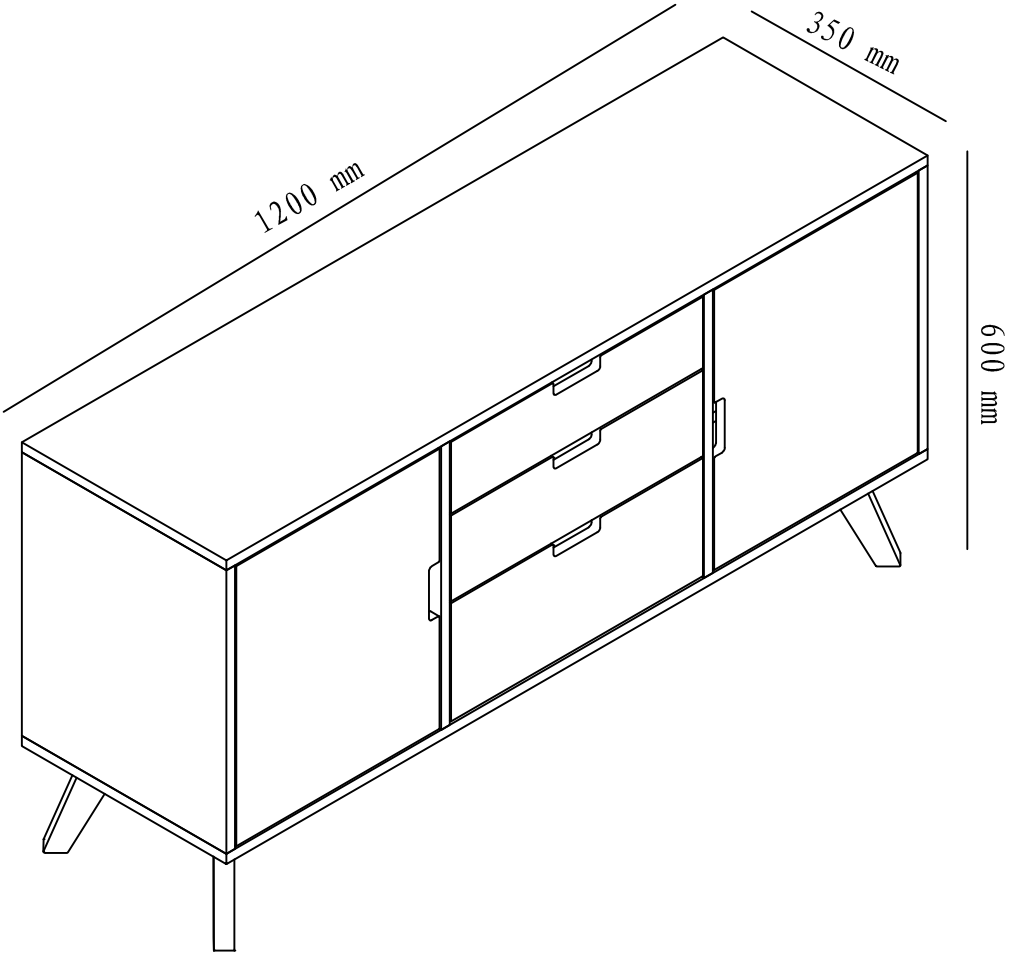

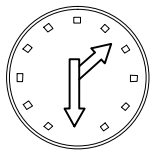





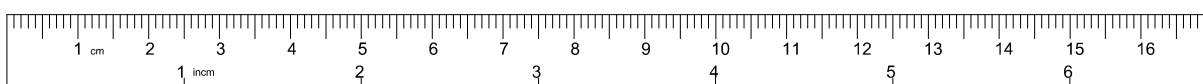
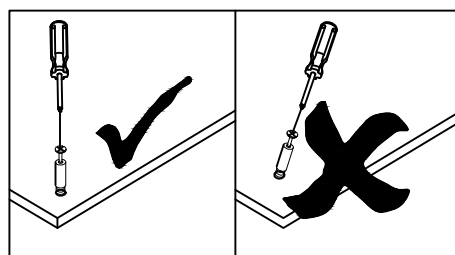
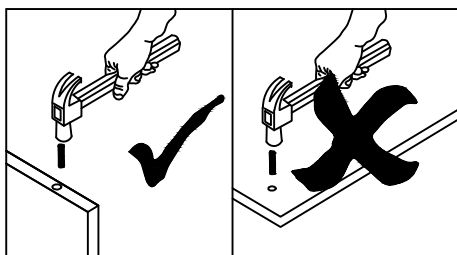
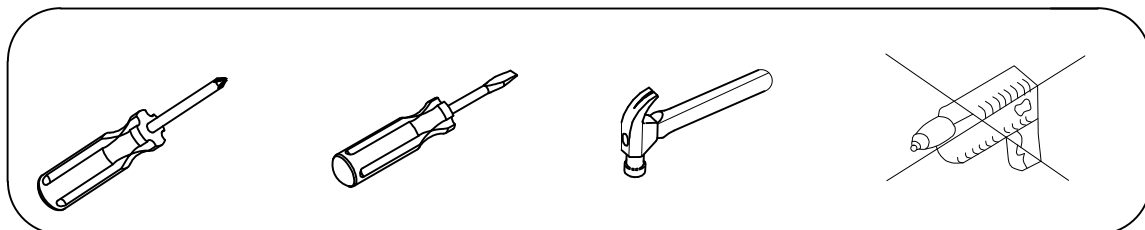
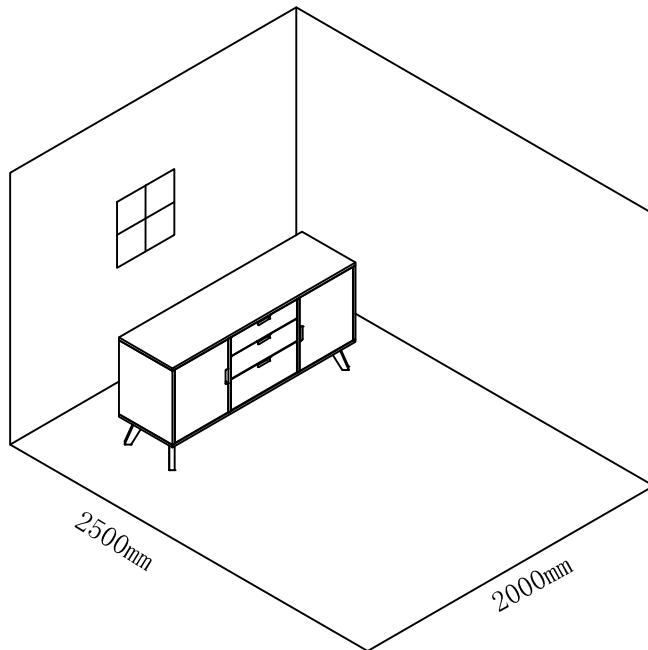
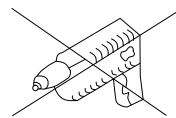
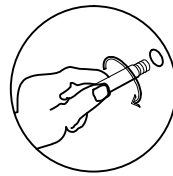
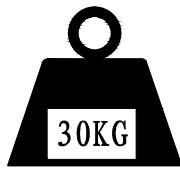
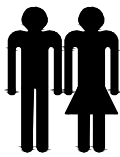

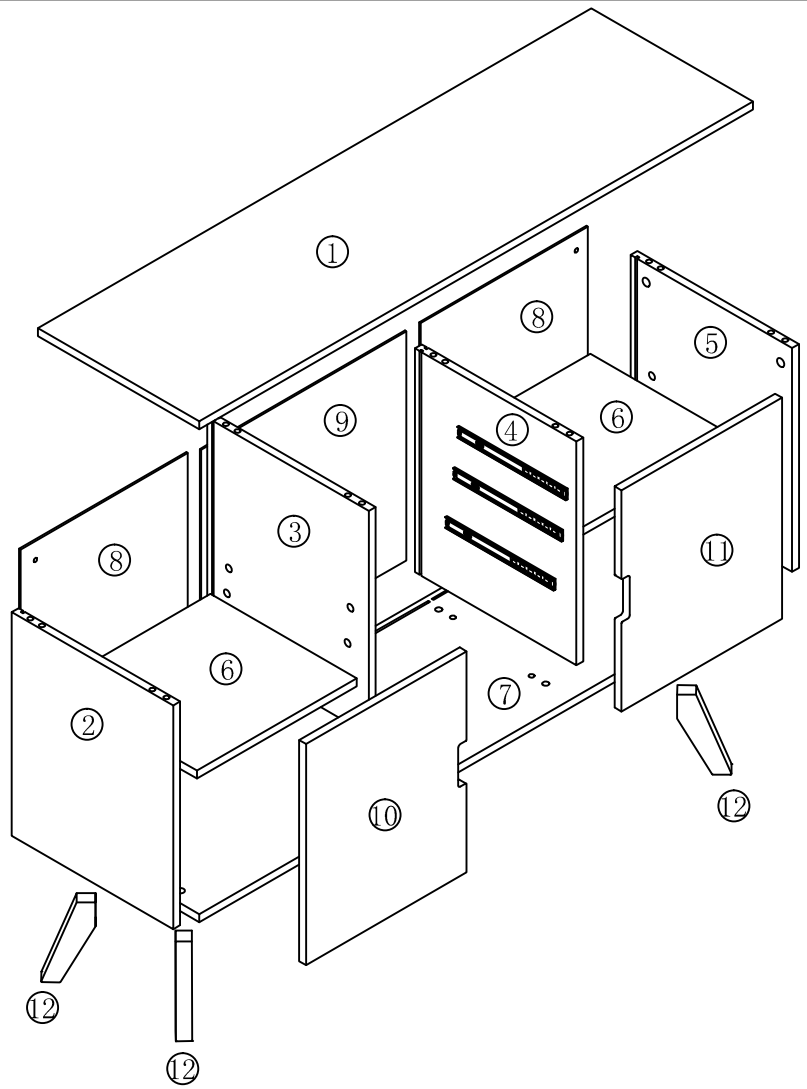
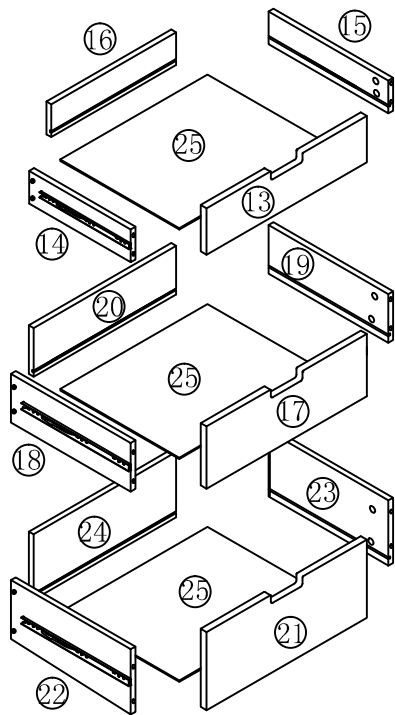



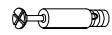











1-13



30 min





 Ax28 $\phi$ 15*9mm	 Bx28 $\phi$ 7*32mm	 Cx8 $\phi$ 3*15mm	 D1x12 $\phi$ 3*25mm	 D2x8 $\phi$ 3*12mm
 D3x28 $\phi$ 3*15mm	 Ex16 $\phi$ 8*30mm	 Fx8 14mm*26mm	 Gx8 M6*40mm	 Hx8 $\phi$ 12* $\phi$ 8mm
 Ix8 M6	 Kx1 M4	 Lx8 16*16*11mm	 Mx2 50*50*9mm	 Nx2 $\phi$ 8*35mm
 Ox2 $\phi$ 4*40mm	 Px20 $\phi$ 20mm	 Rx4	 Sx4	 Tx4 20*20*3mm
 U1x2	 Vx2 $\phi$ 16* $\phi$ 4mm	 Wx2 $\phi$ 3*15mm		

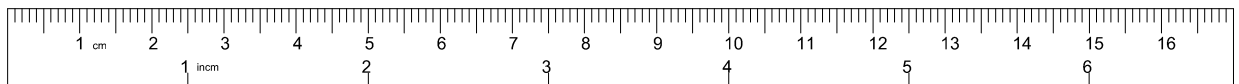

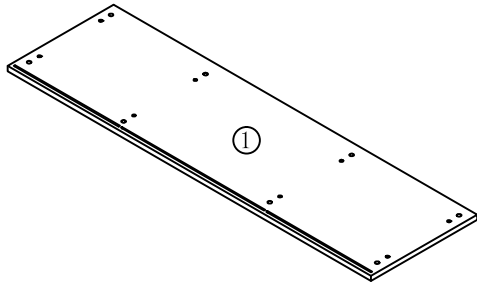

1200\*350\*15mm 1PC

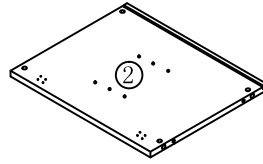

420\*350\*15mm 1PC

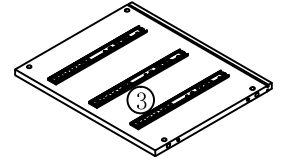

420\*350\*15mm 1PC

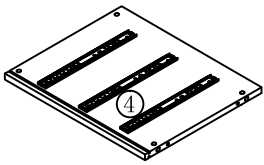

420\*350\*15mm 1PC

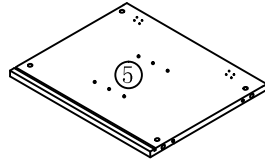

420\*350\*15mm 1PC

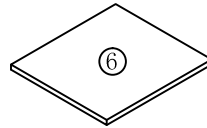

346\*317\*12mm 2PCS

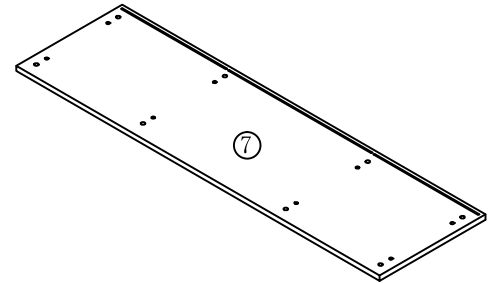

1200\*350\*55mm 1PC

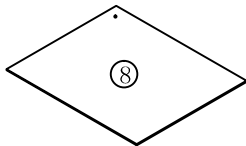

428\*360\*3mm 2PCS

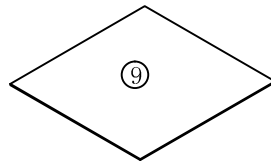

428\*440\*3mm 1PC

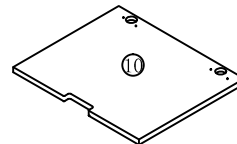

415\*348\*15mm 1PC

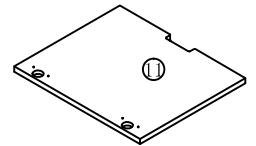

415\*348\*15mm 1PC

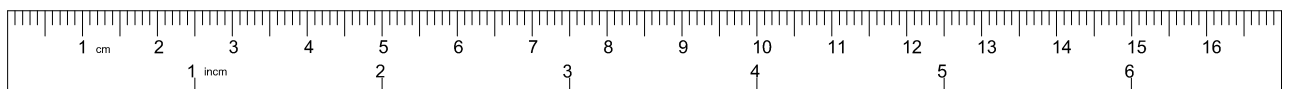



12

170\*43\*25mm 4PCS

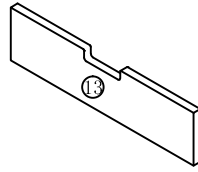

13

431\*106\*15mm 1PC

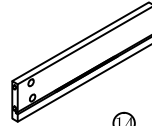

14

300\*80\*12mm 1PC

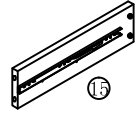

15

300\*80\*12mm 1PC

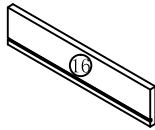

16

386\*80\*12mm 1PC

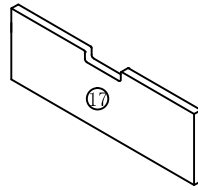

17

431\*127\*15mm 1PC

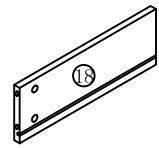

18

300\*100\*12mm 1PC

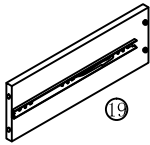

19

300\*100\*12mm 1PC

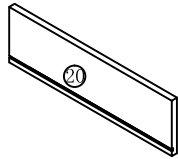

20

386\*100\*12mm 1PC

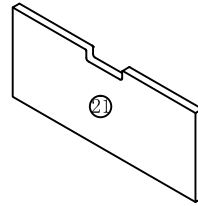

21

431\*175\*15mm 1PC

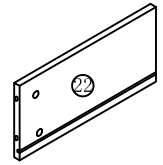

22

300\*130\*12mm 1PC

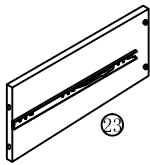

23

300\*130\*12mm 1PC

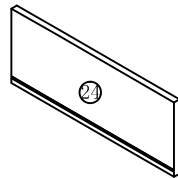

24

386\*130\*12mm 1PC

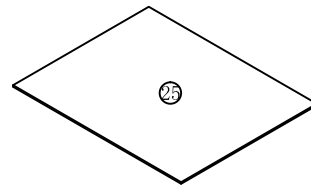

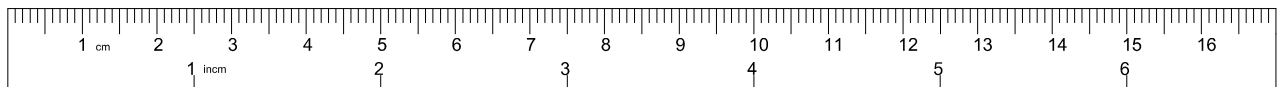

25

394\*296\*3mm 3PCS



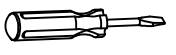

1

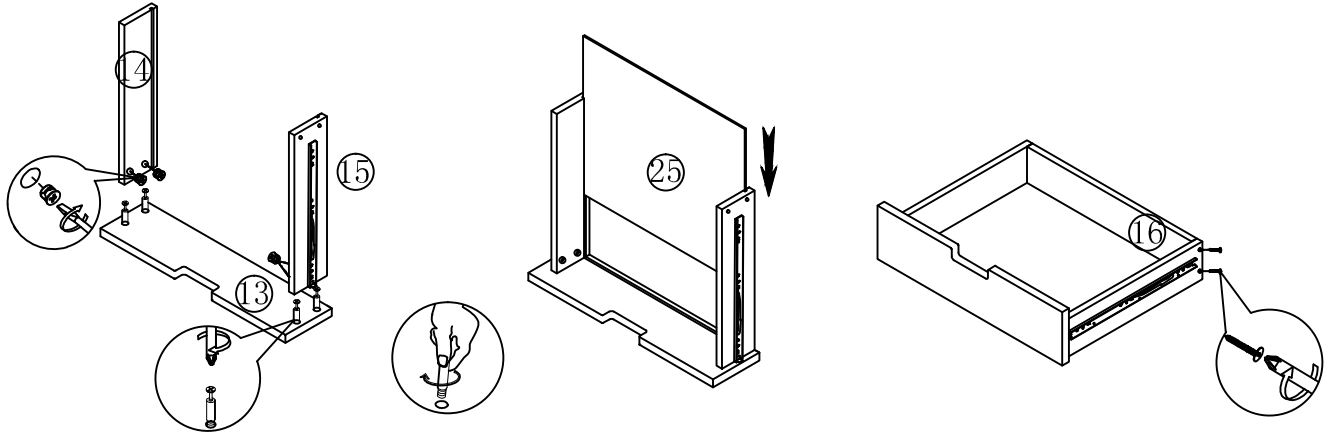
A	 x4	B	 x4	D1	 x4		
---	--	---	--	----	--	--	---





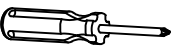
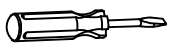

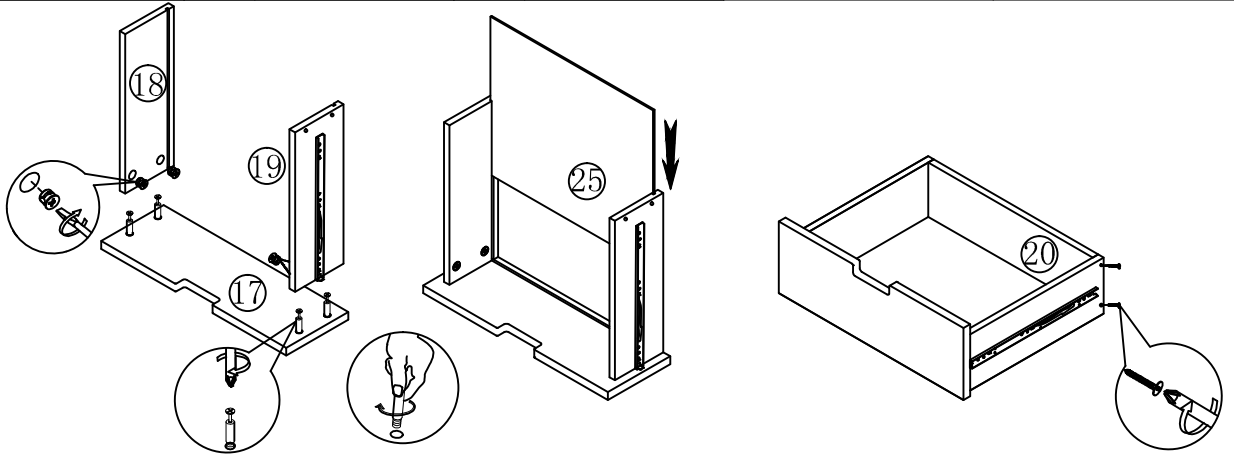
2

A	 x4	B	 x4	D1	 x4		
---	--	---	--	----	--	--	---





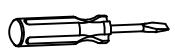

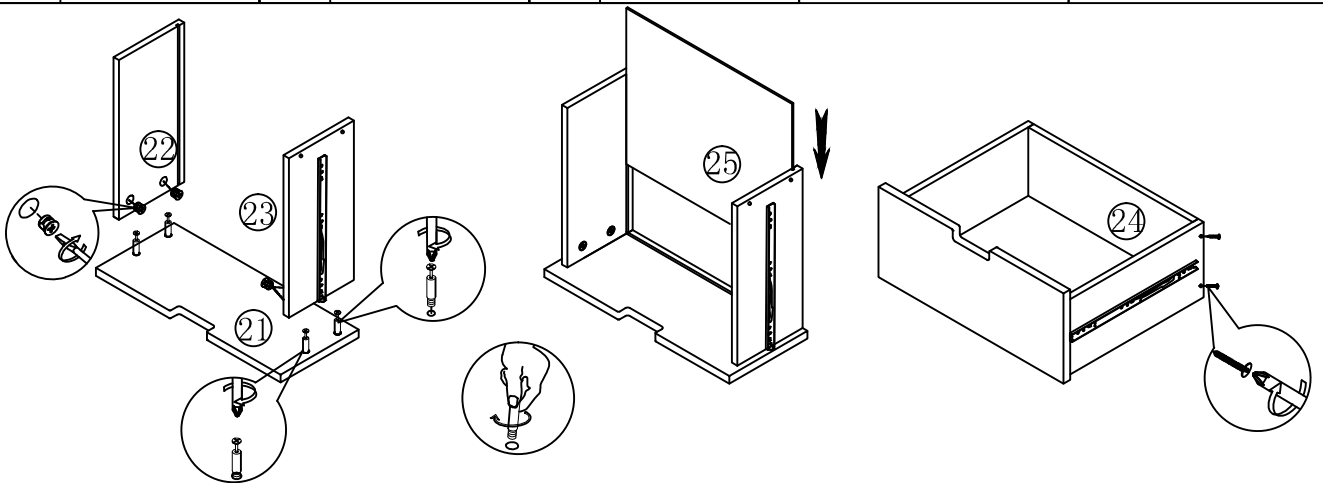

3

A	 x4	B	 x4	D1	 x4		
---	--	---	--	----	--	---	---



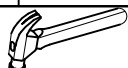

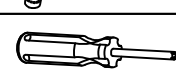
4

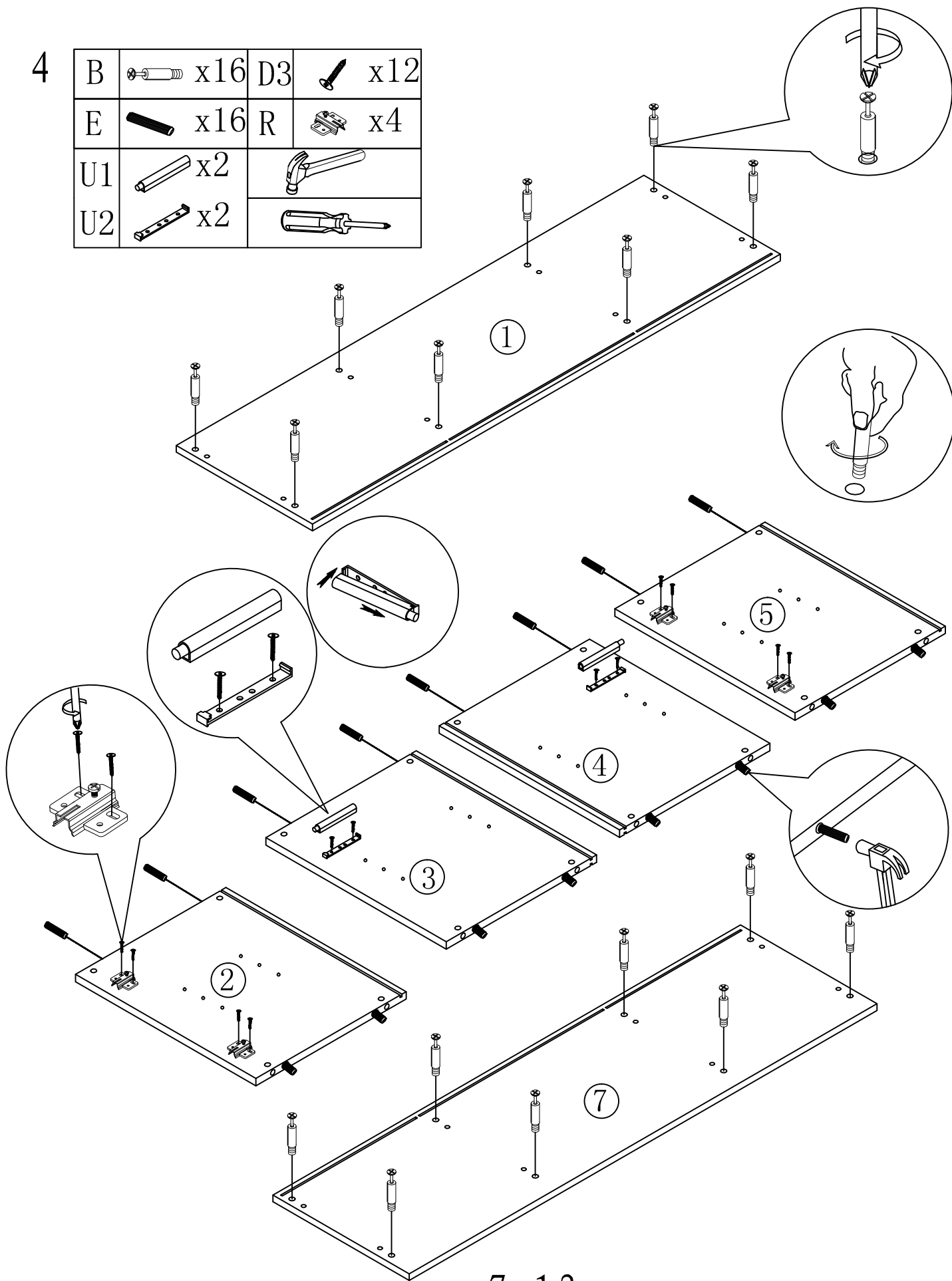
B	 x16	D3	 x12
E	 x16	R	 x4
U1	 x2		
U2	 x2		



5

A		x8
		

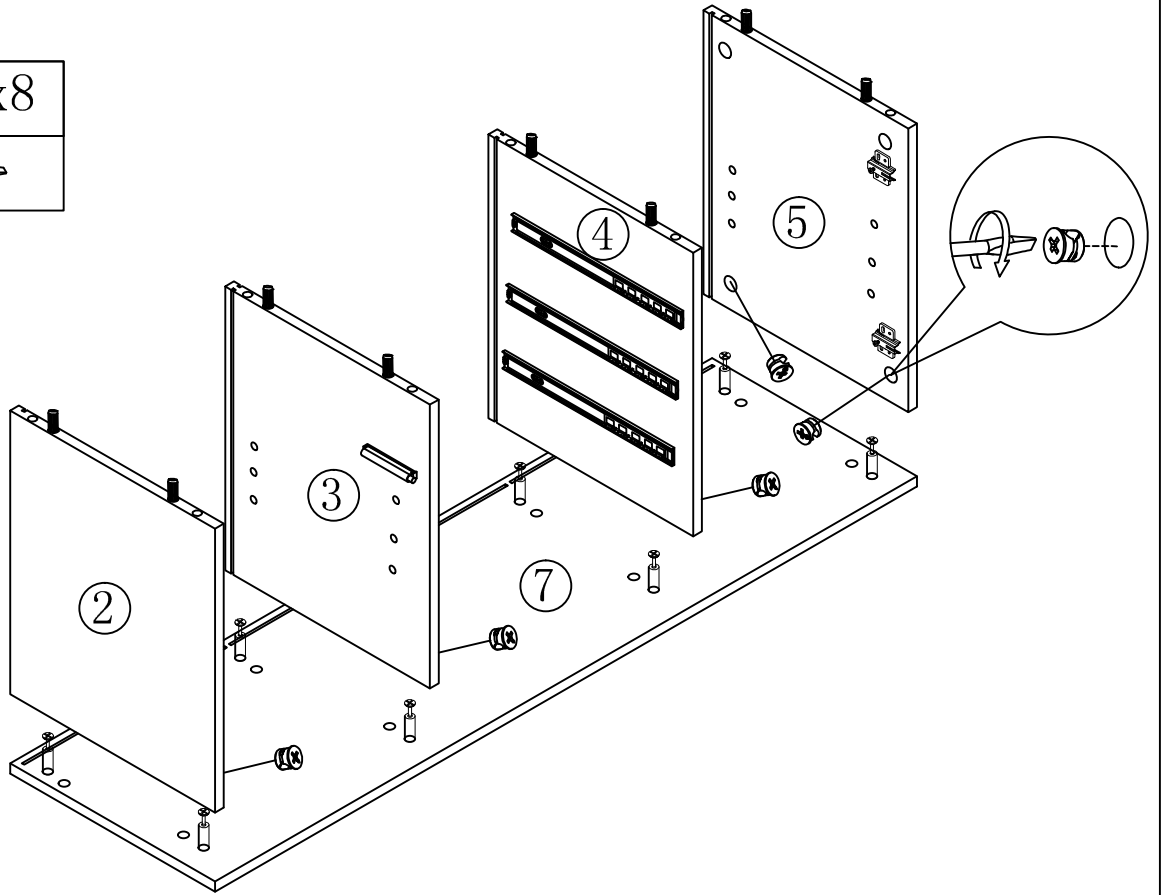

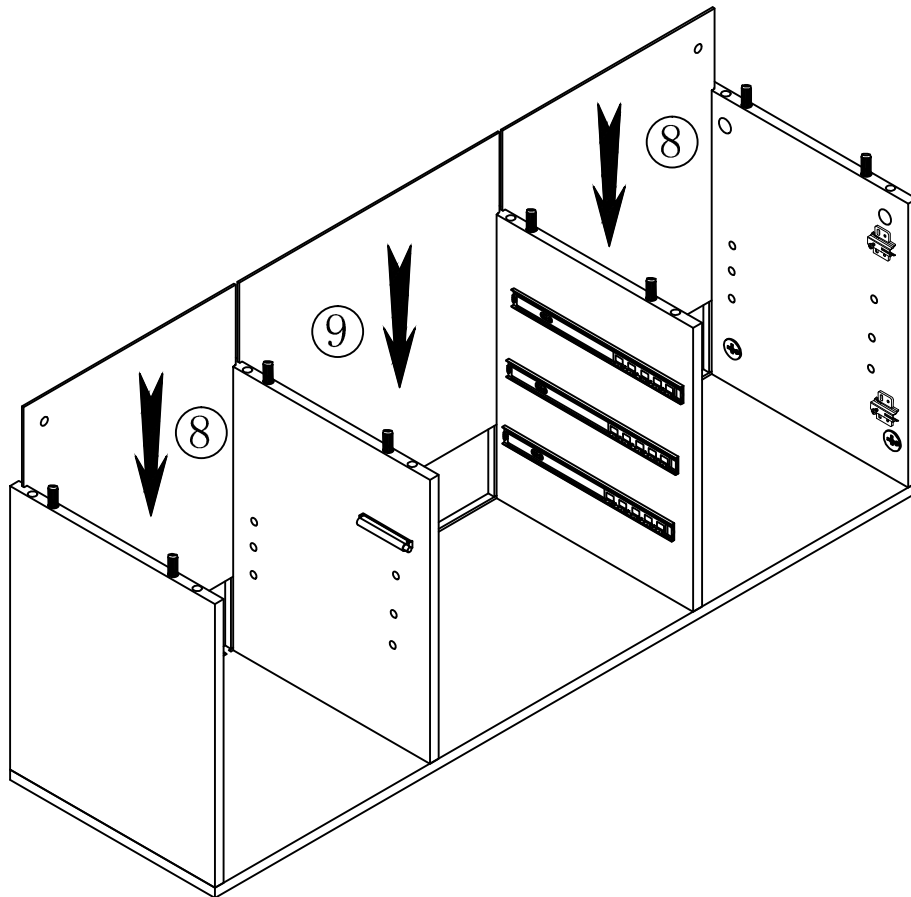

6



8-13







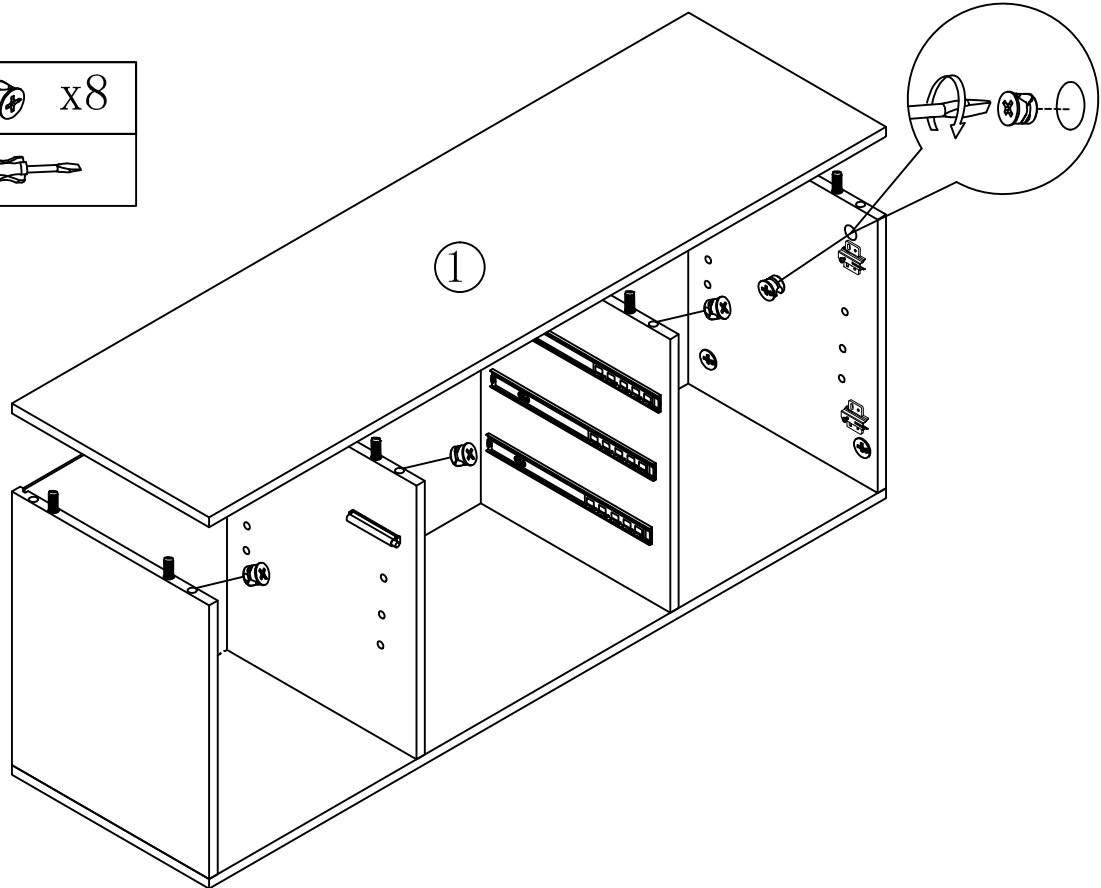



7

A	 x8
	



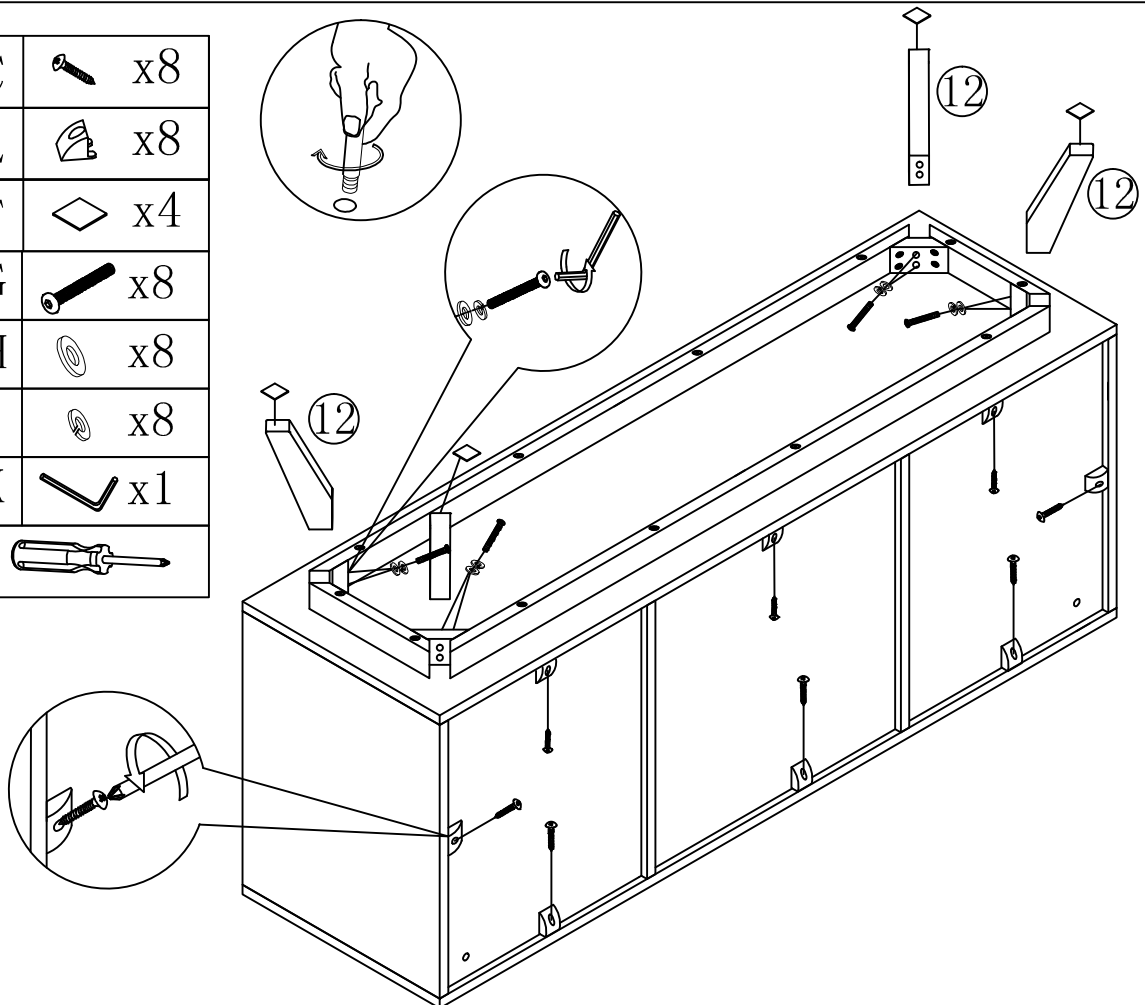

8

C	 x8
L	 x8
T	 x4
G	 x8
H	 x8
I	 x8
K	 x1
	



9-13

9

F		x8
D2		x8

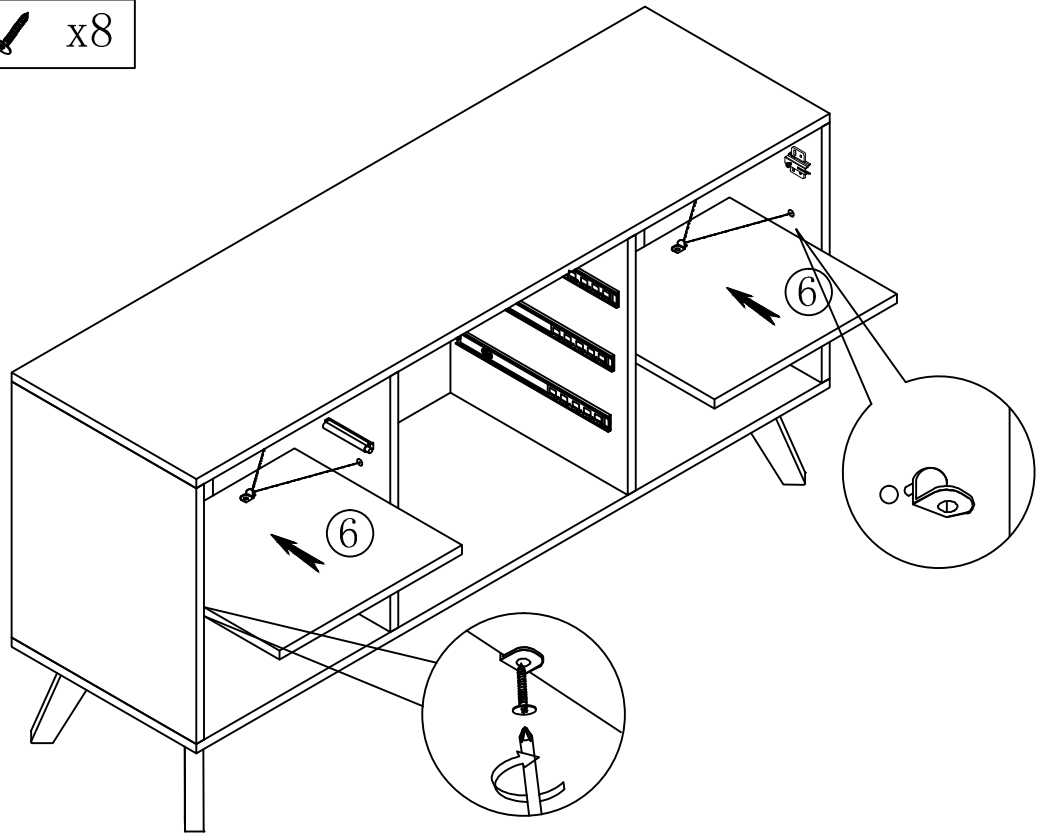

10

P		x8
---	---	----

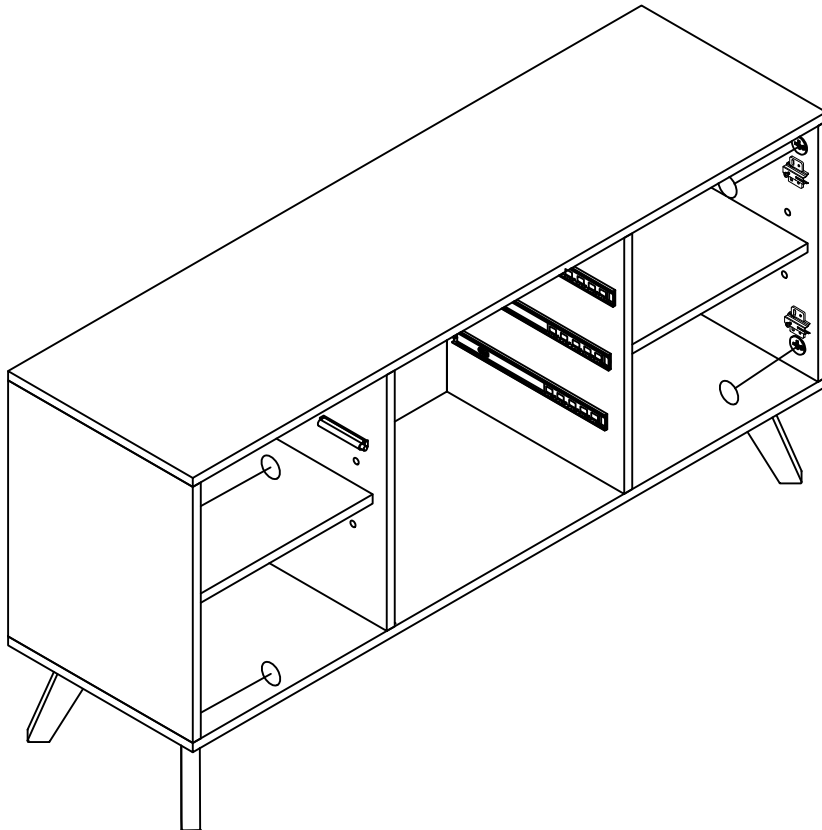



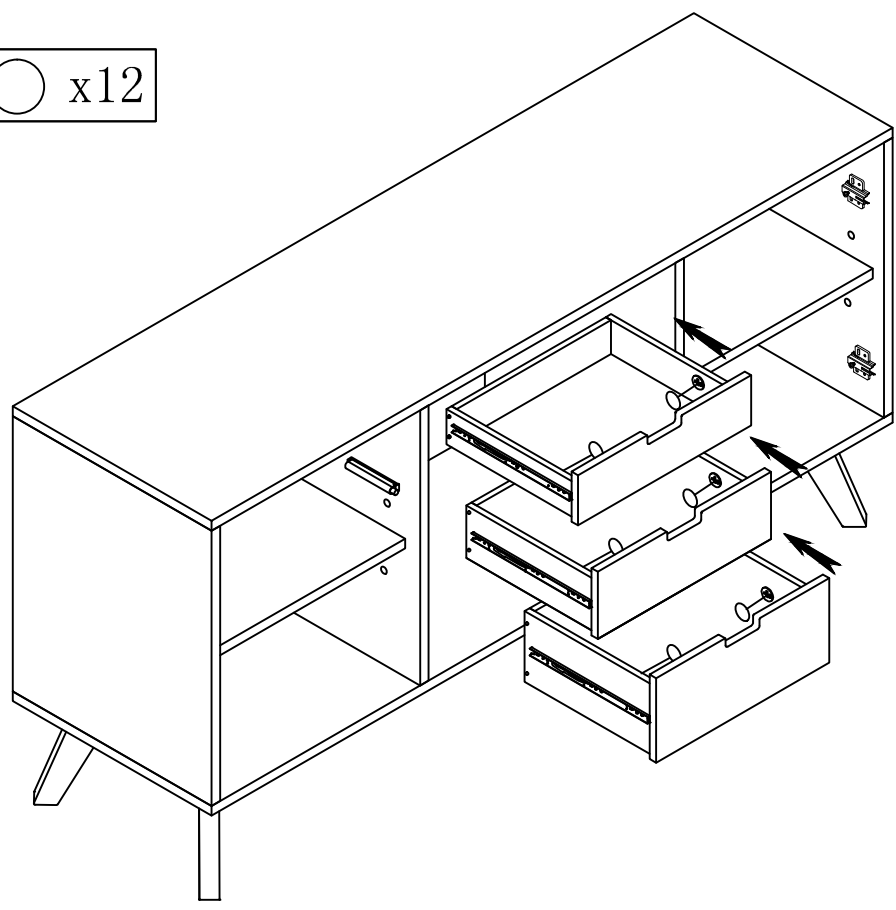

10-13

11 P ○ x12

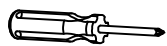

12

S		x4
D3		x8
V		x2
W		x2
		

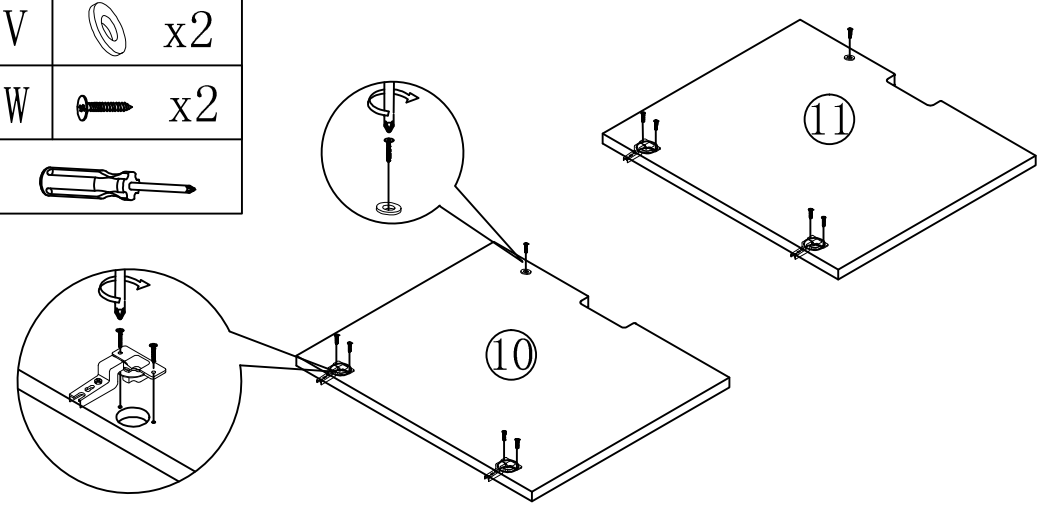

11-13

13

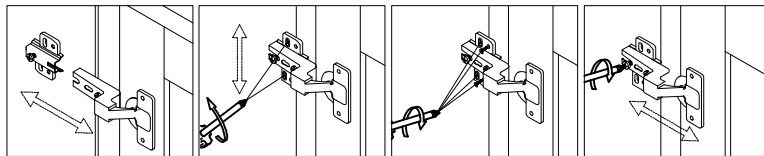
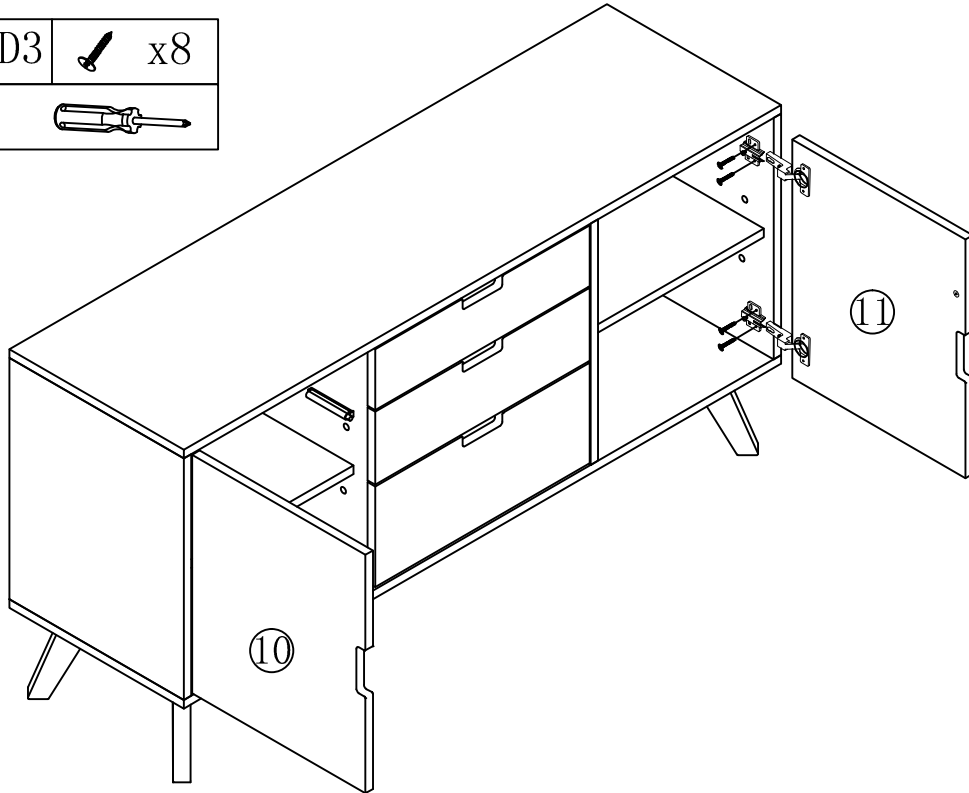
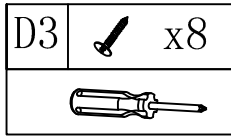

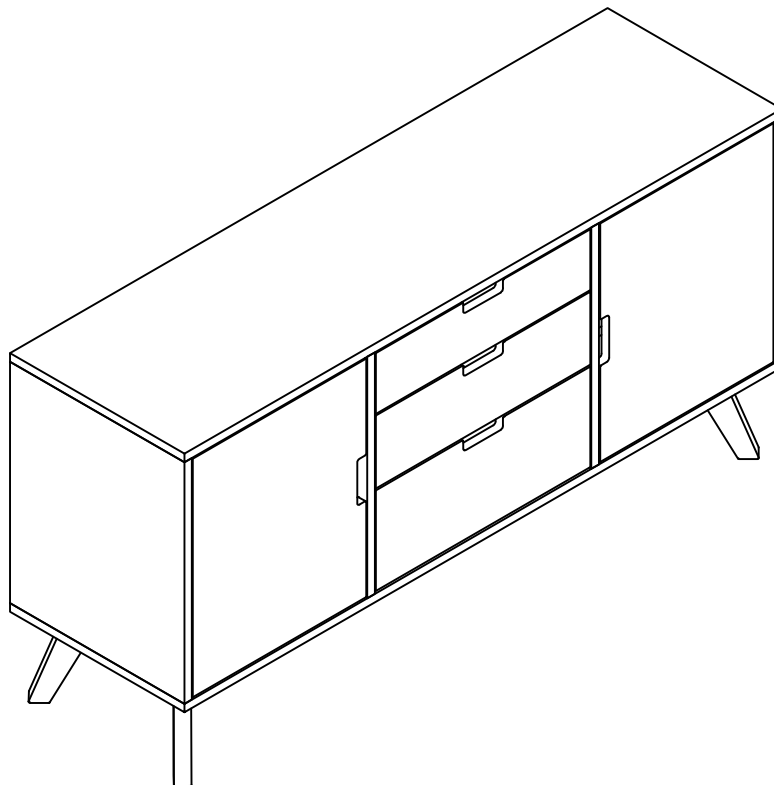

14



12-13

15

M		x2
N		x2
O		x2
