

1803

LINATE LTB01 R

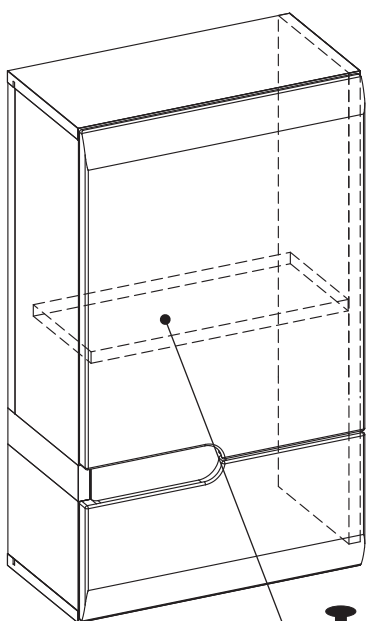

- 30 min.



 max.
5 kg

- | | |
|--------|--------|
| ① - C1 | ⑤ - C1 |
| ② - C1 | ⑥ - C1 |
| ③ - C1 | ⑦ - C1 |
| ④ - C1 | ⑧ - C1 |



LINATE LTB01 R

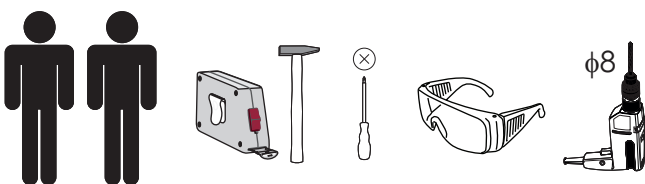
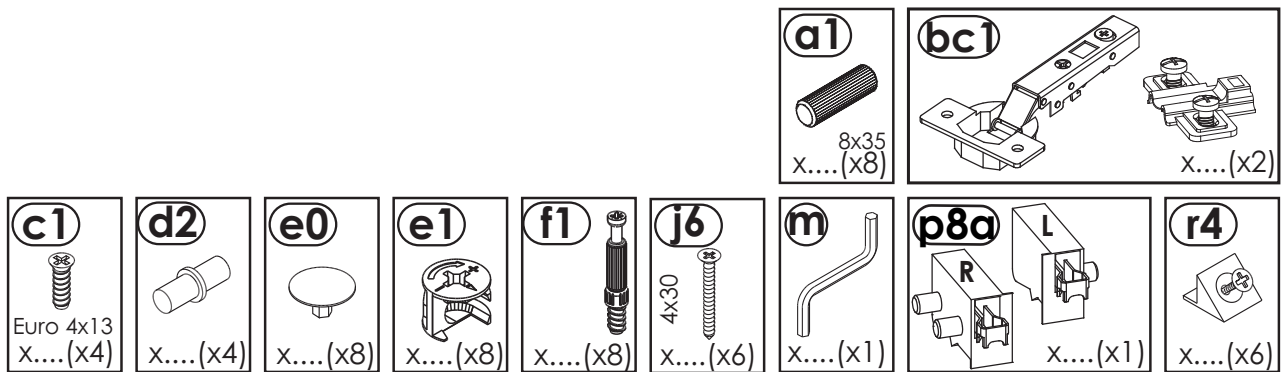
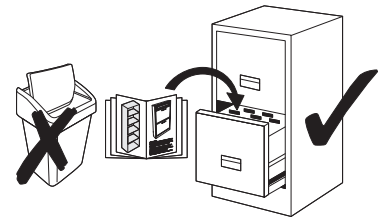
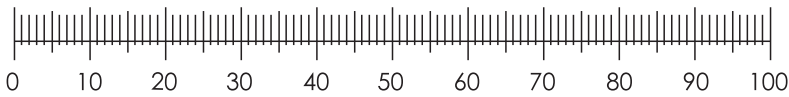
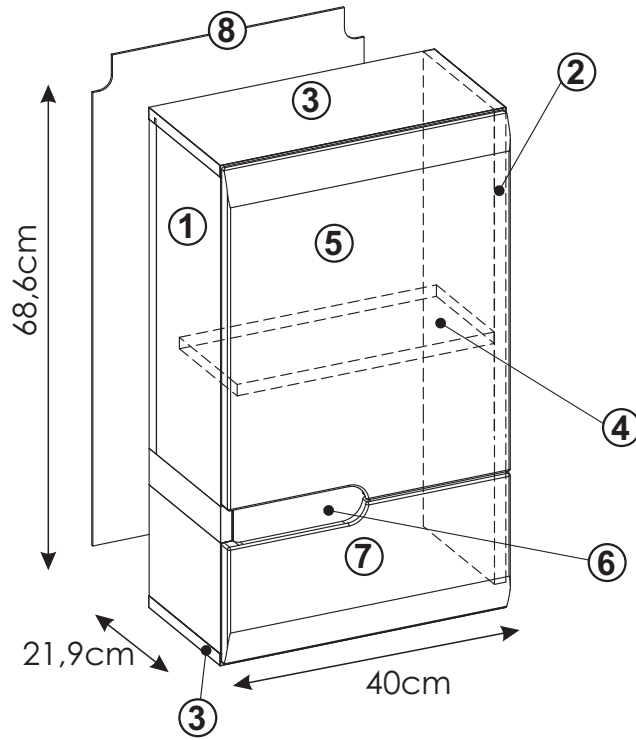

1

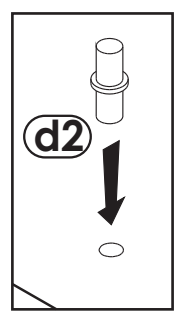
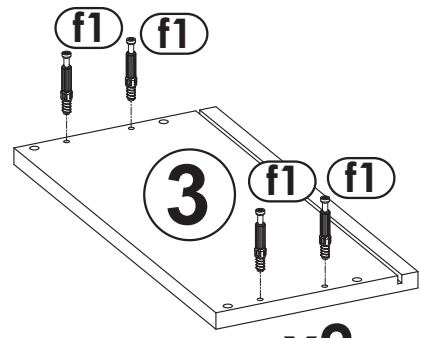
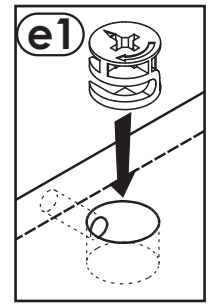
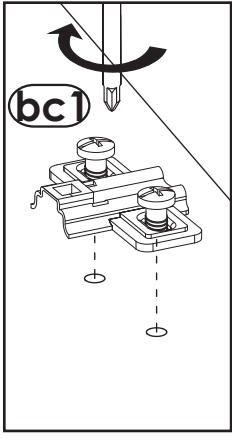
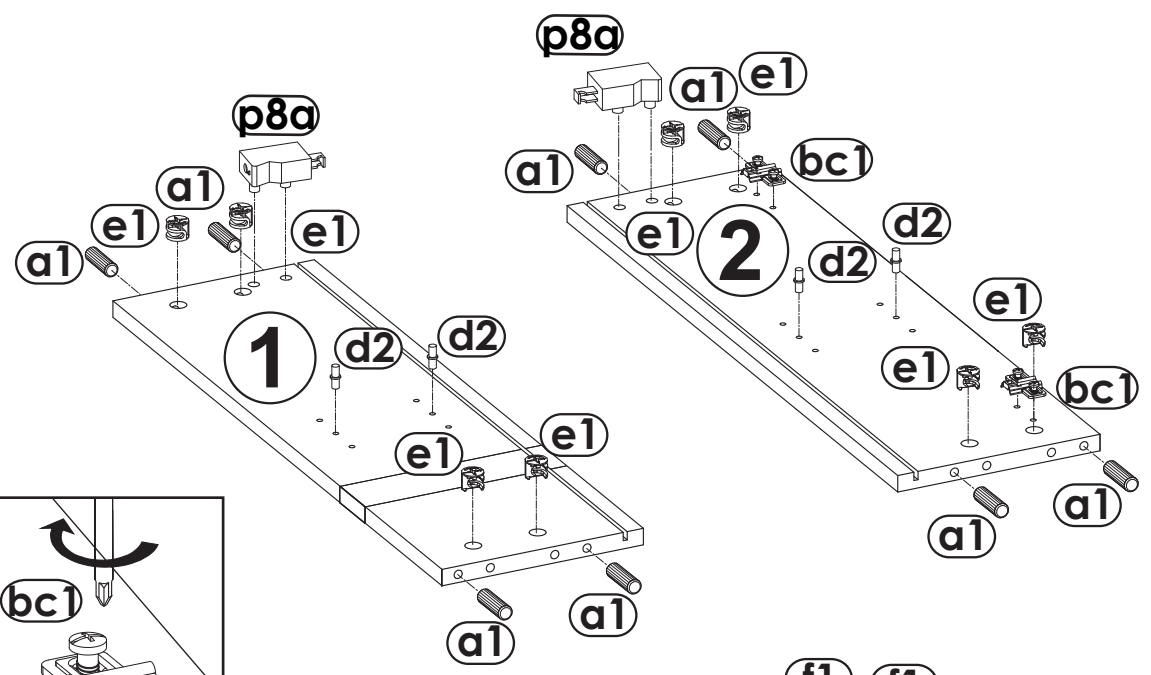
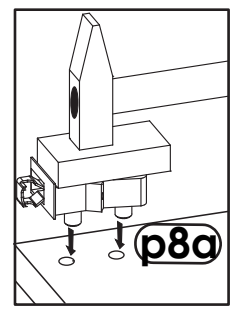
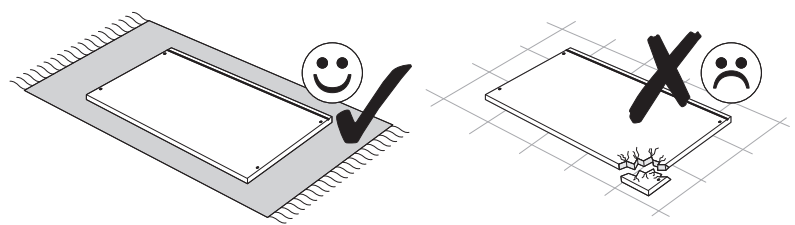

x2

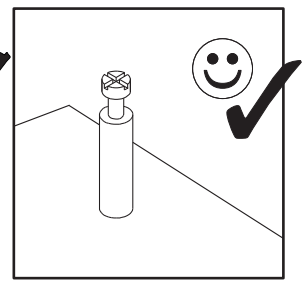
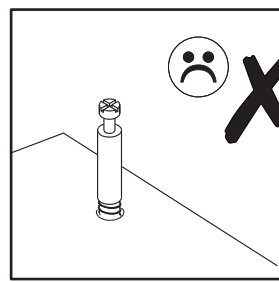
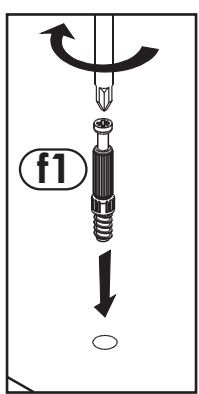
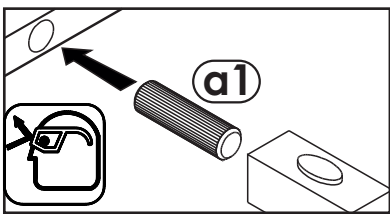
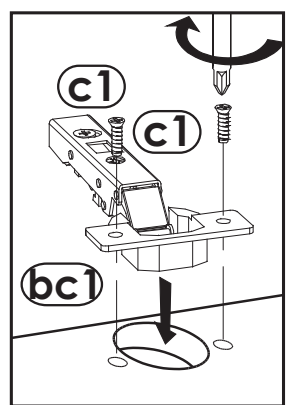
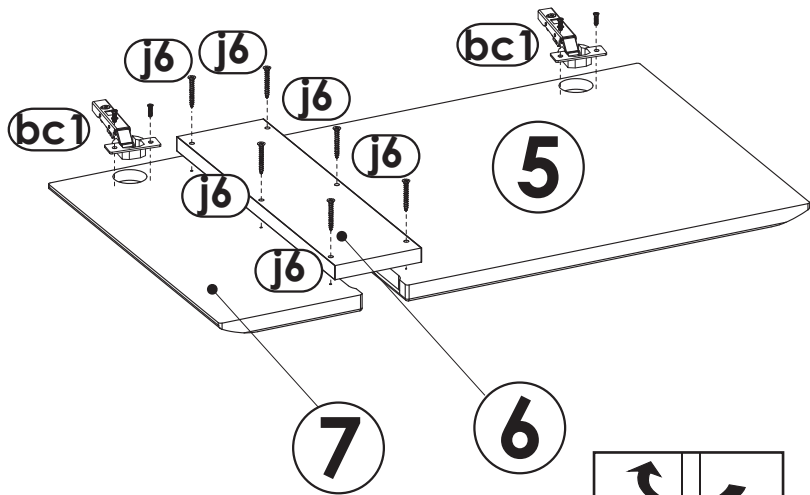

2

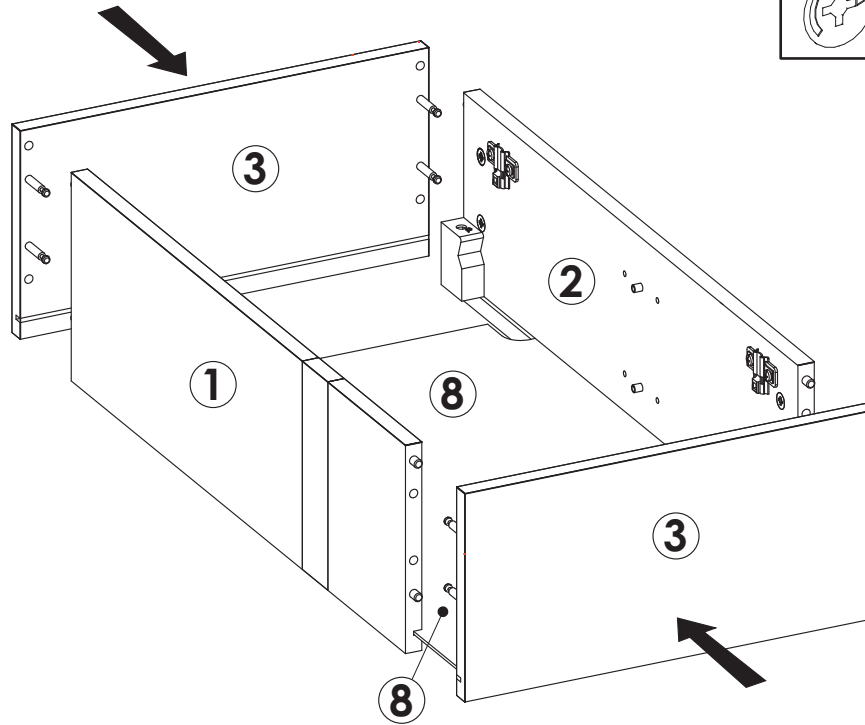
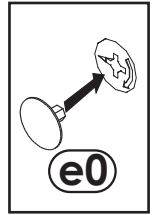
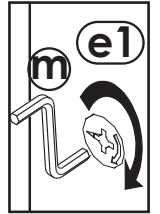
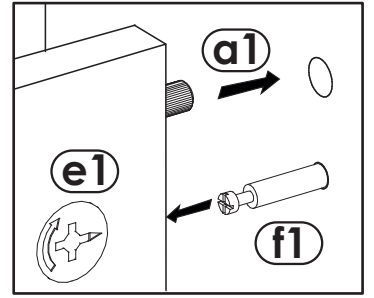
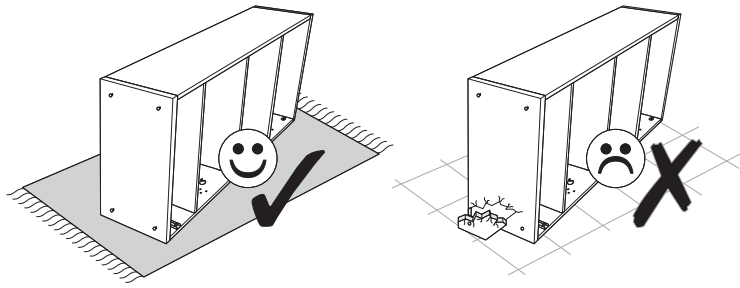

3

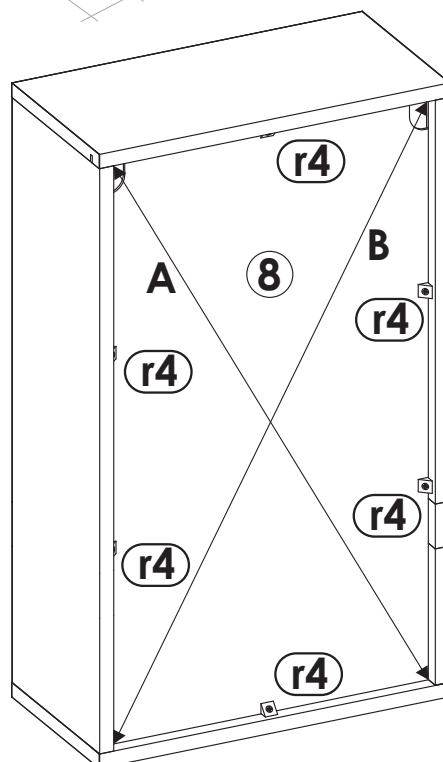
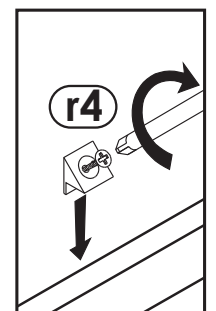
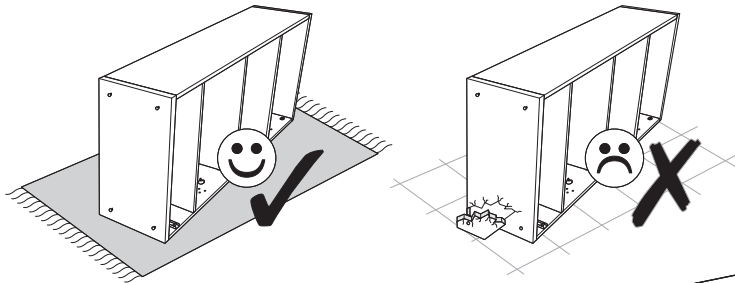

A=B

4
▼

