

OPTION 1

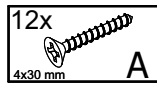

OPTION 1

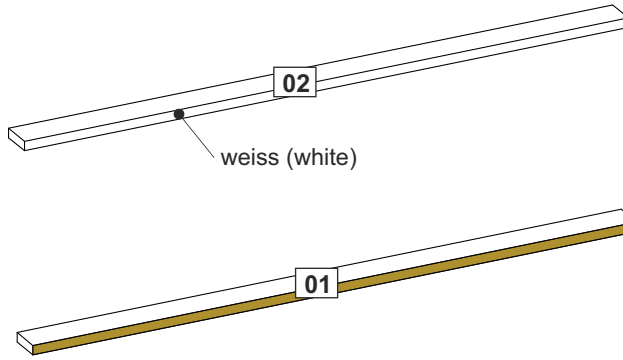
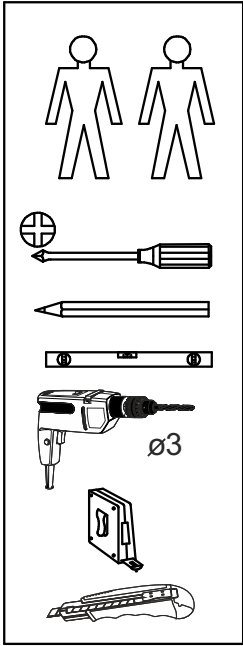
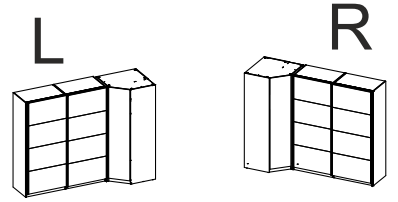

OPTION 2

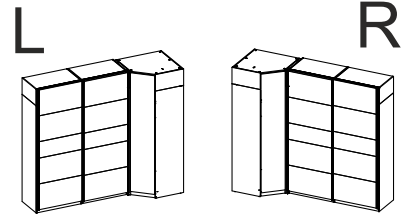

01	2100x110x32	1/1
02	2100x110x32	1/1

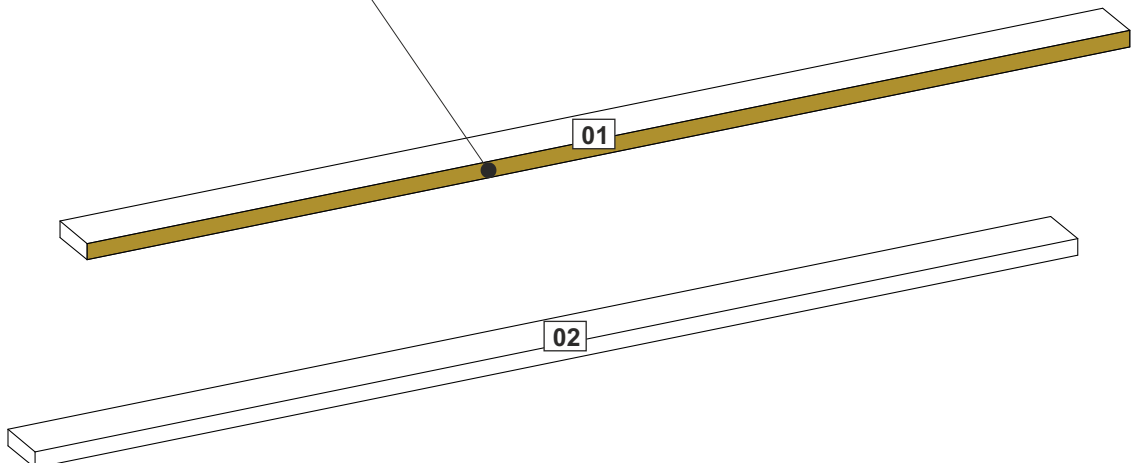
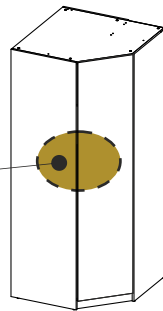
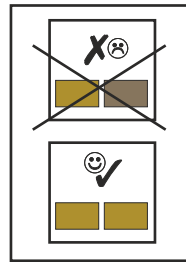
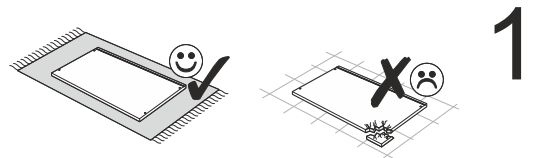
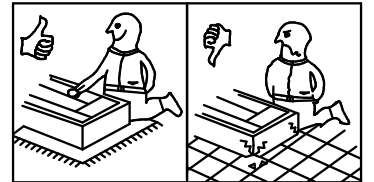
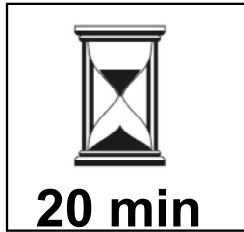

UNIT 96

2

12x
4x30 mm
A

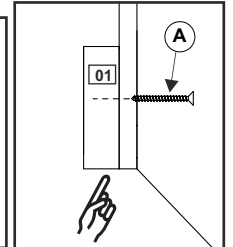
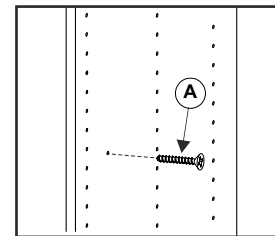
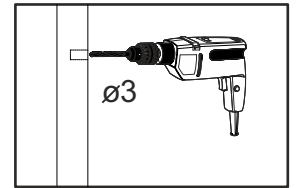
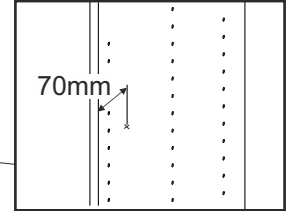
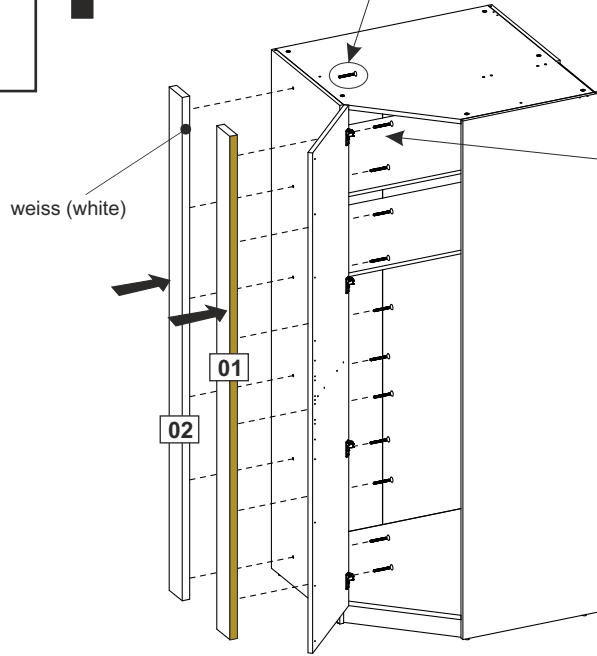
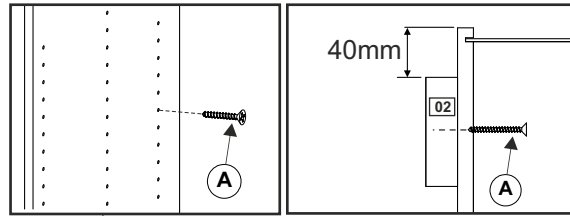
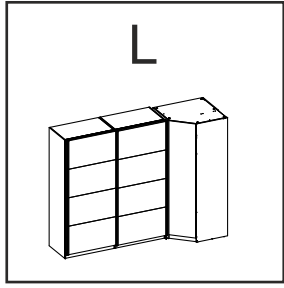

3

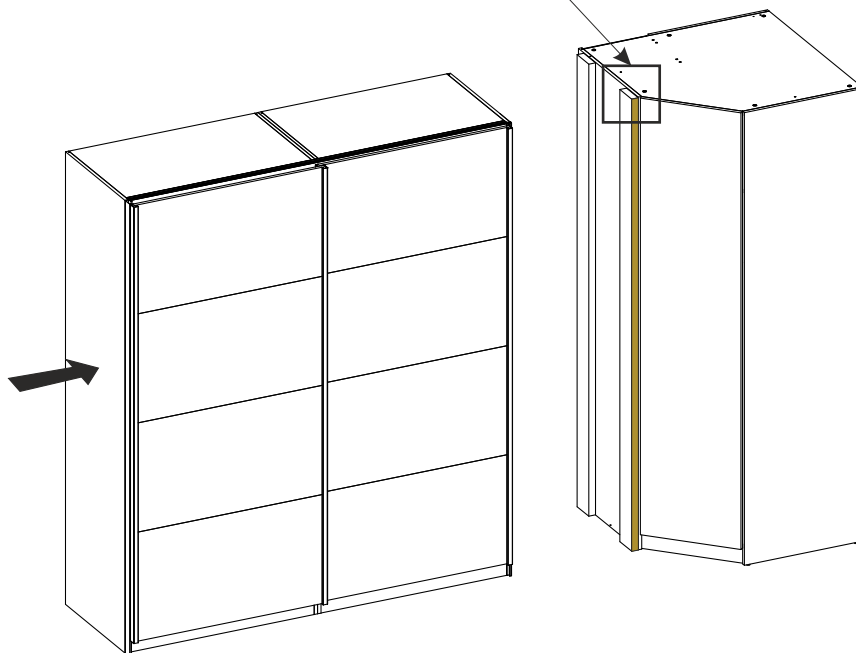
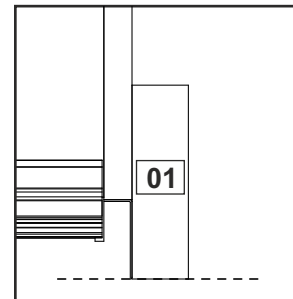
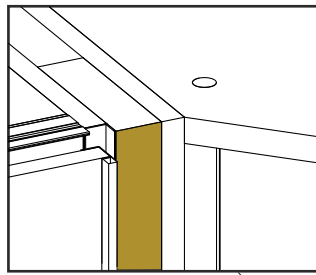
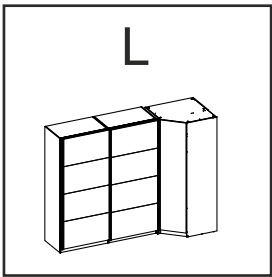

UNIT 96

12x
4x30 mm
A

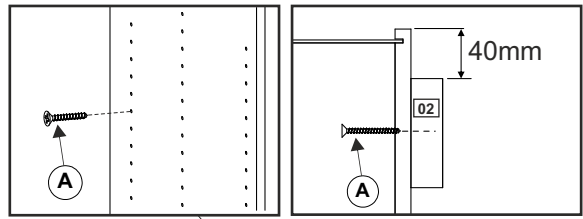
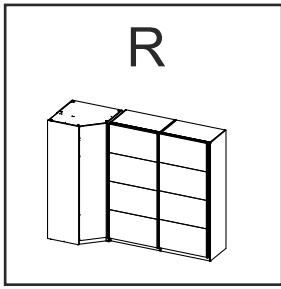

4

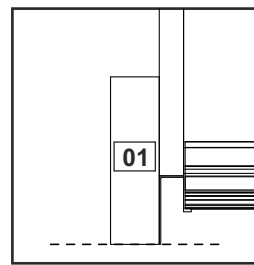
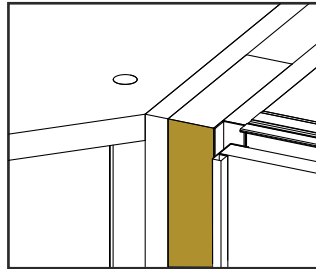
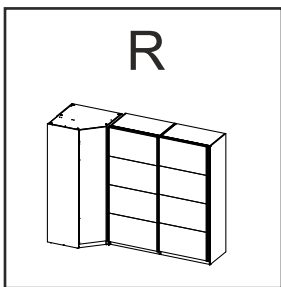
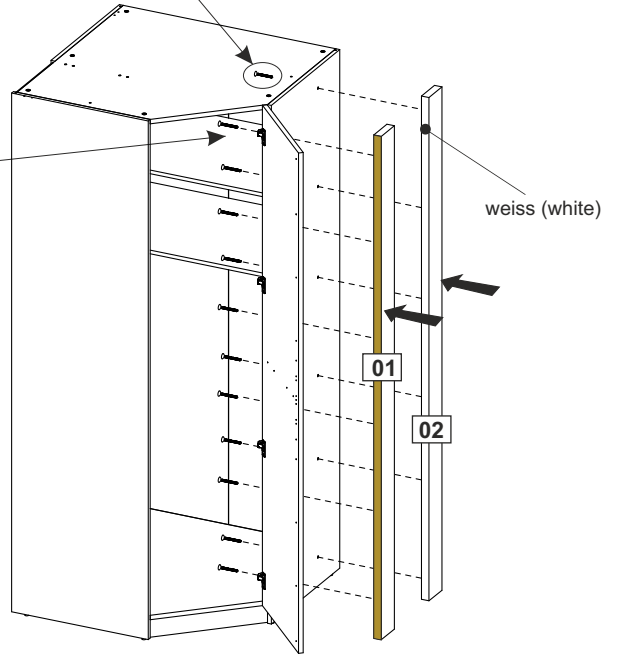
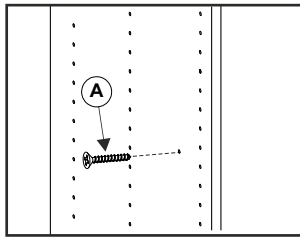
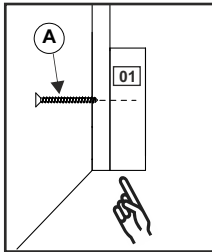
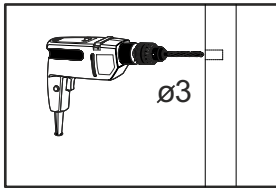
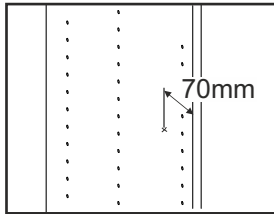

5

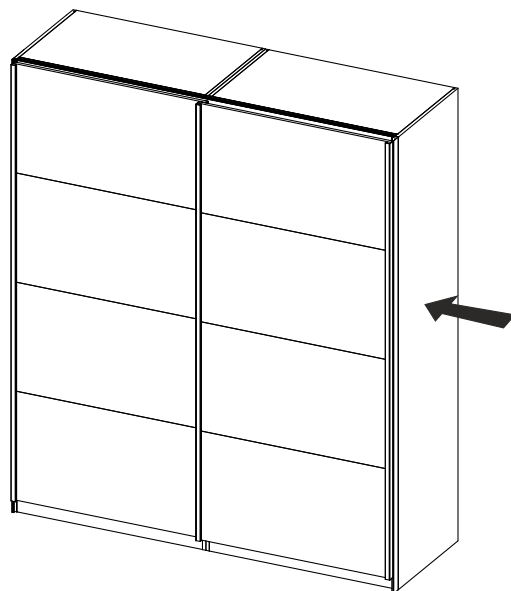
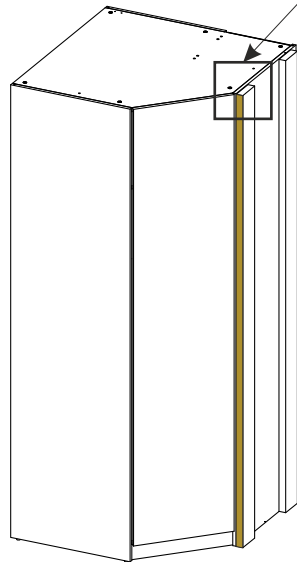

UNIT 96

OPTION 2

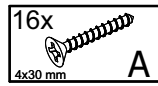
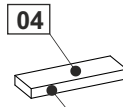
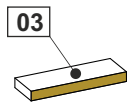
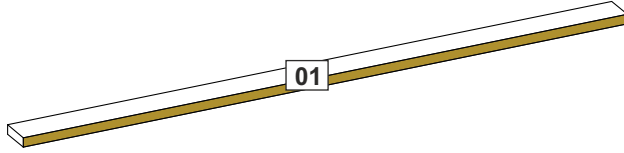
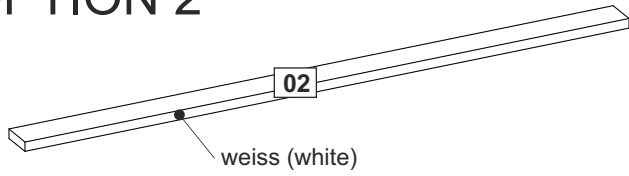
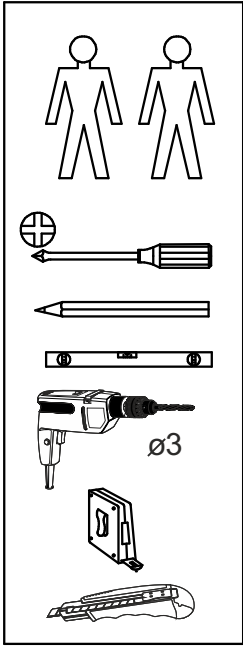

OPTION 1

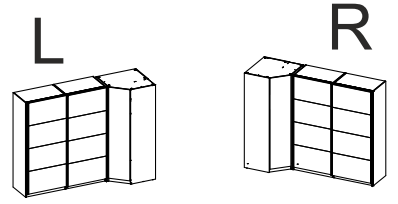

OPTION 2

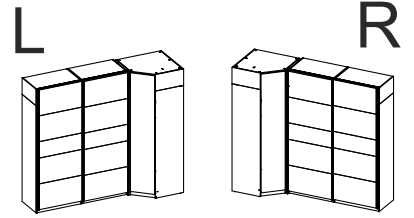

01	2100x110x32	1/1
02	2100x110x32	1/1
03	322x110x32	1/1
04	322x110x32	1/1

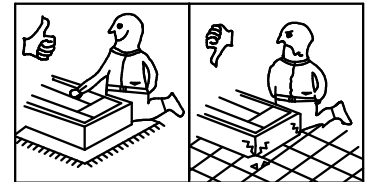

1

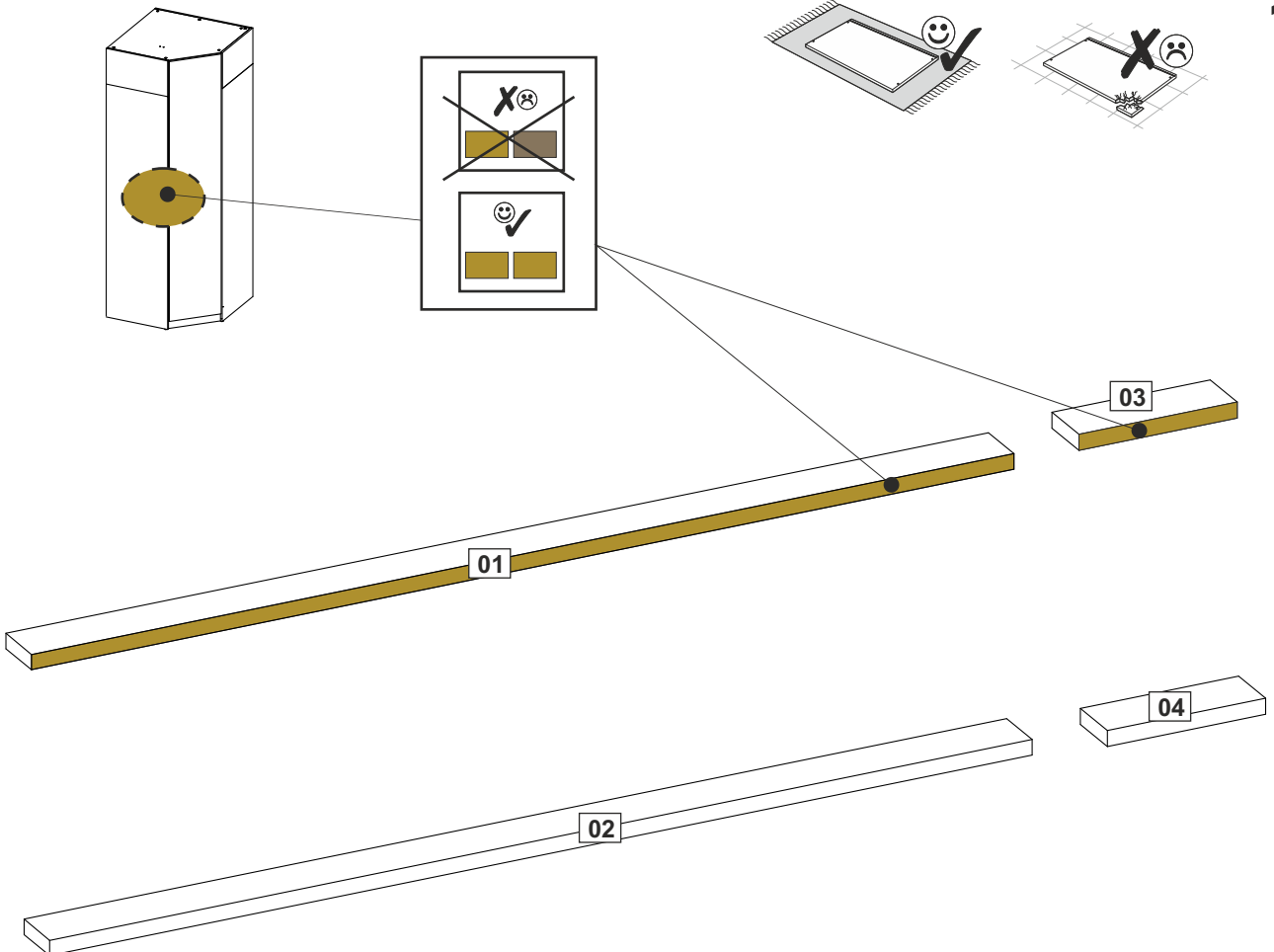

UNIT 96

2

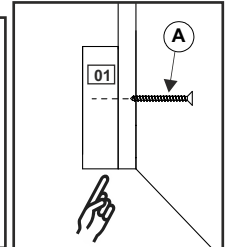
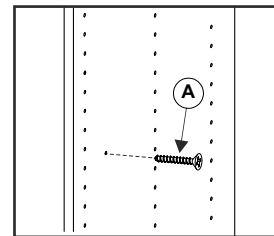
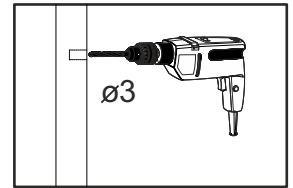
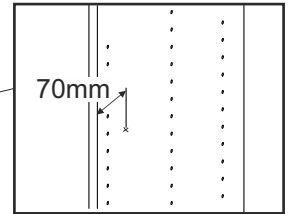
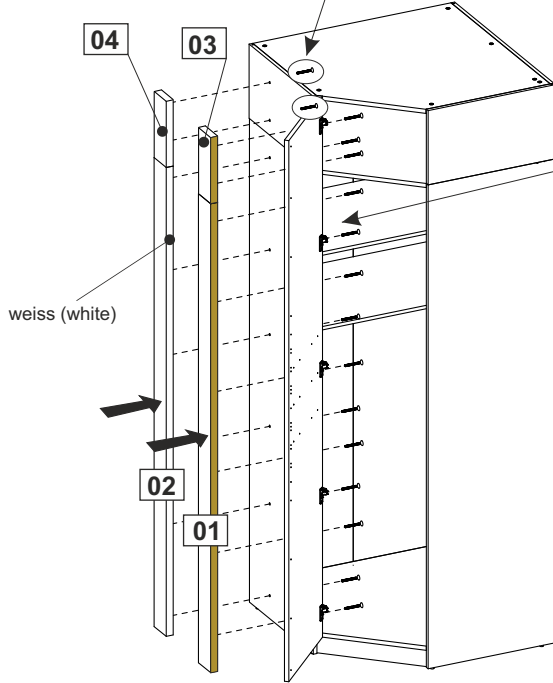
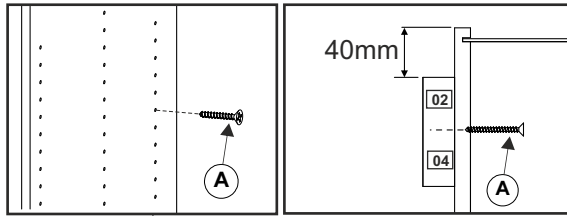
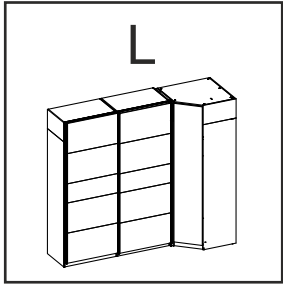
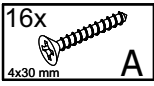

3

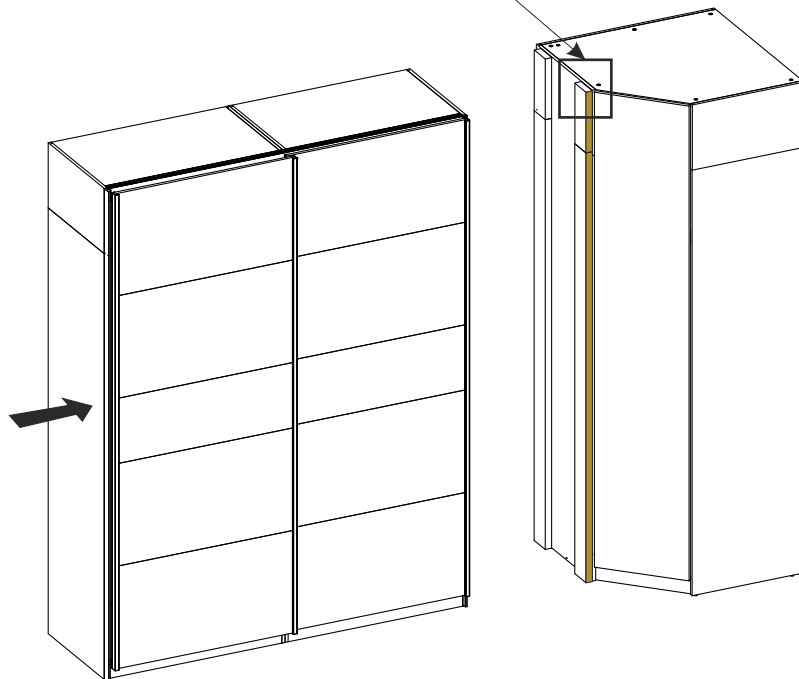
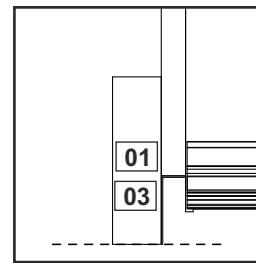
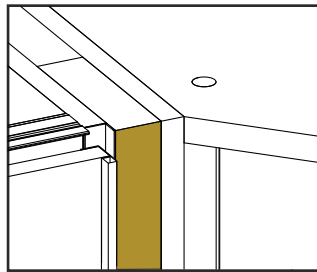
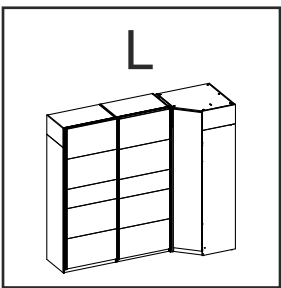

UNIT 96

4

16x
4x30 mm
A

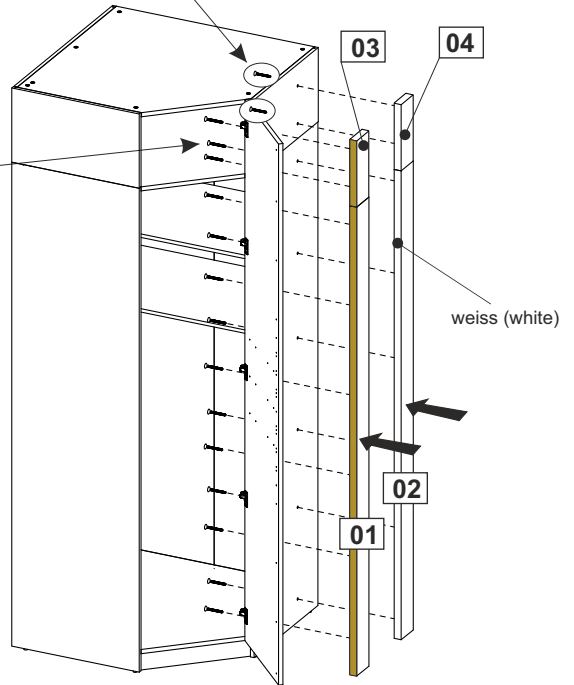
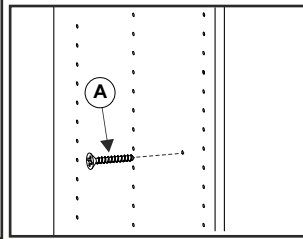
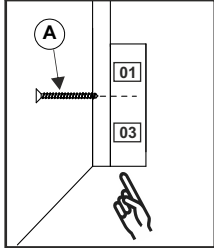
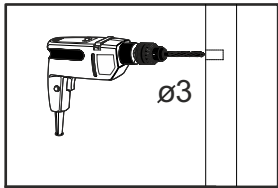
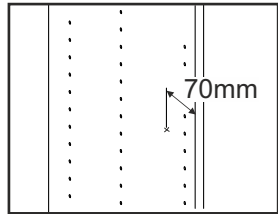
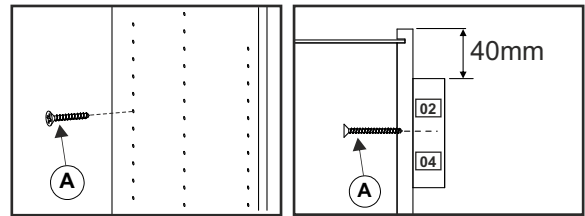
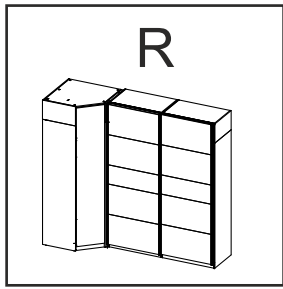

5

