











05750273-01/02

|   |   |   |  |  |  |
|---|---|---|--|--|--|
|                |                | 1<br><br>1x    | 2<br><br>1x | 3<br><br>1x | A<br><br>M6x16mm 8x |
| B<br><br>M4 1x | C<br><br>M6 8x | D<br><br>M6 4x | E<br><br>1x |  |  |

**STEP 1**

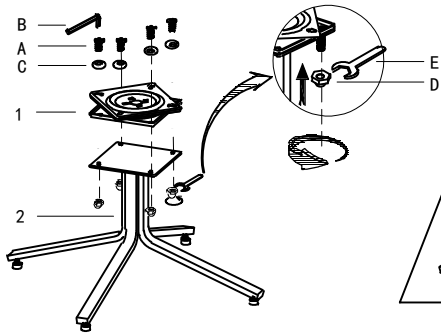

**STEP 2**

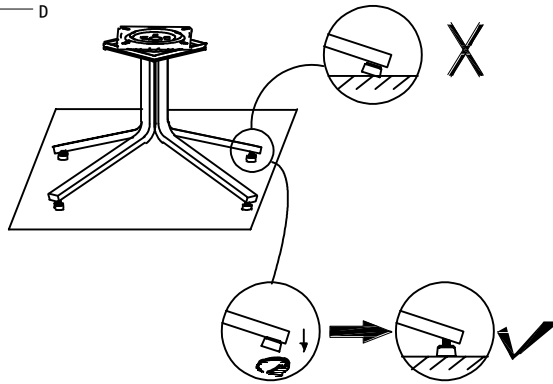

**STEP 3**

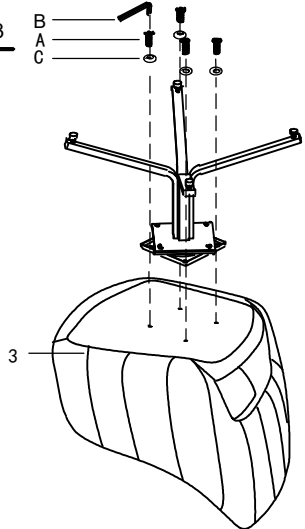

**STEP 4**

