

# INSTRUCTION SHEET

22240018-02

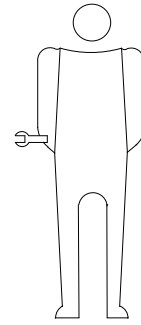

x1

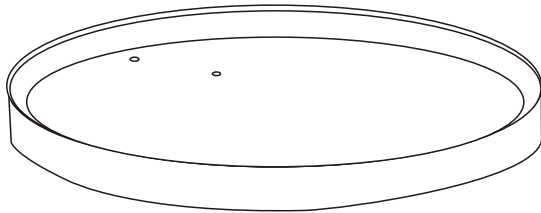



Ax1



Bx1

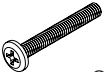

Cx3

 ax6	 bx2	 cx3					

# Step 1

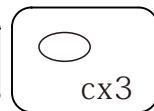
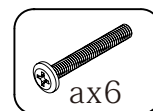
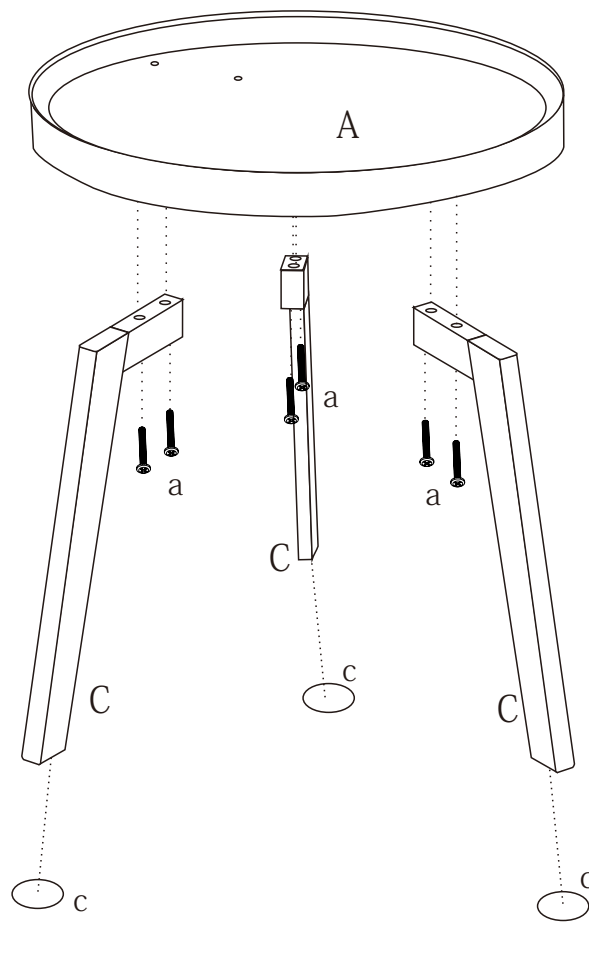

# Step 2

