

7/9 LR

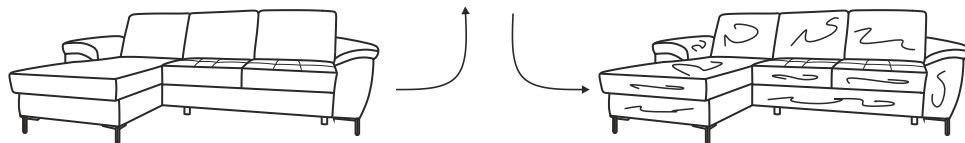

8/9 LR

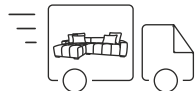
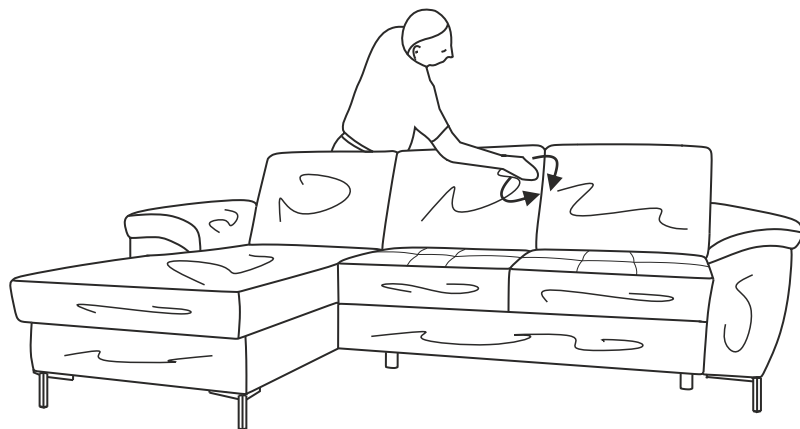

9/9 LR

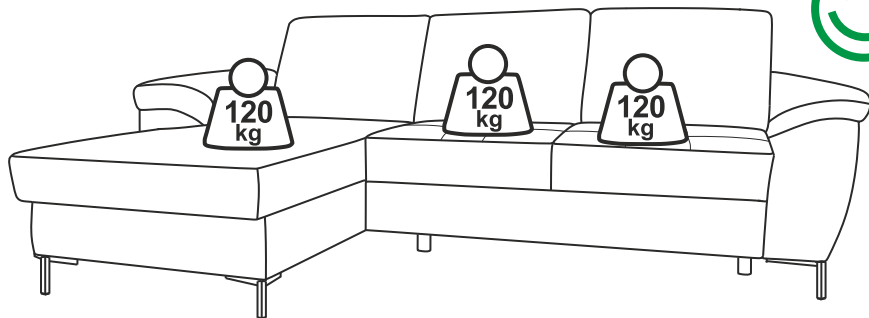

F.P.H. EUROMEBEL STYL-FENIKS TARTAK GRZEGORZ STRZODA  
42-610 Miasteczko Śląskie  
ul. Cynkowa 47  
Polskakontakt@euromebelstyl.pl

4

Model: FOCUS L2

Nr:8120151

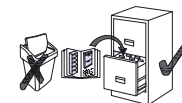
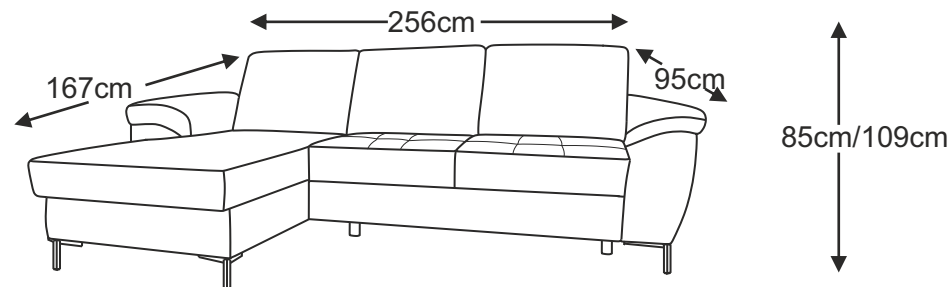

L

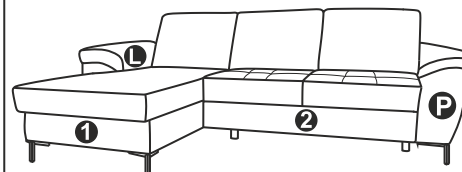

R

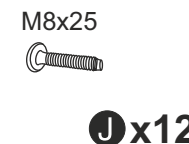
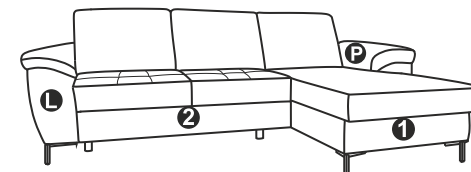

Die Kopfstütze ist als Zusatzoption erhältlich.  
Die entsprechenden Öffnungen sind immer vorhanden.

The headrest is available as an optional add-on.  
The corresponding openings are always present.

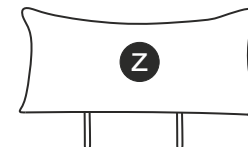

1

1/9 L

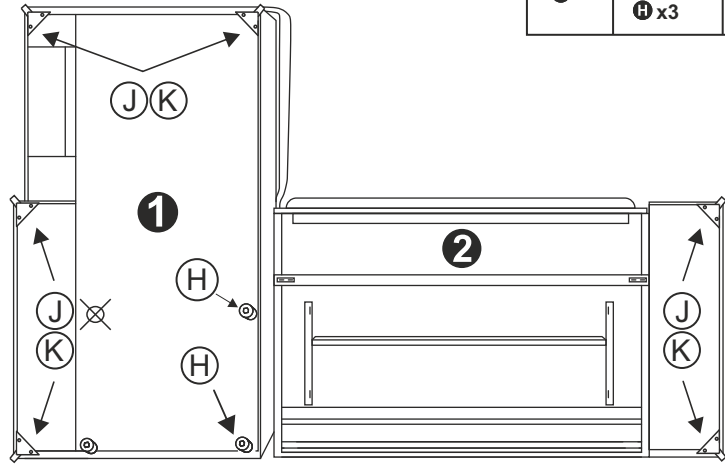
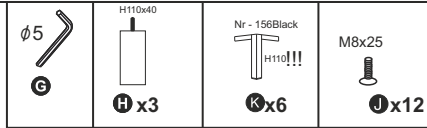

2/9 L

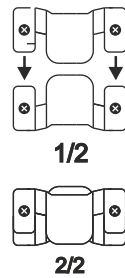
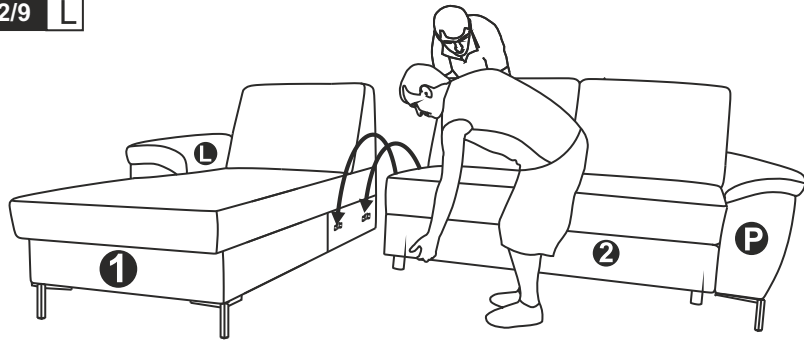

4/9 R

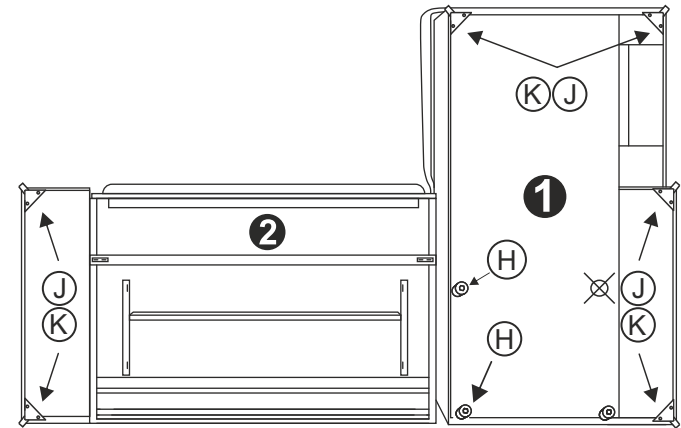

5/9 R

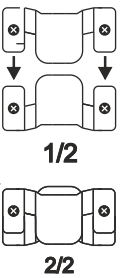
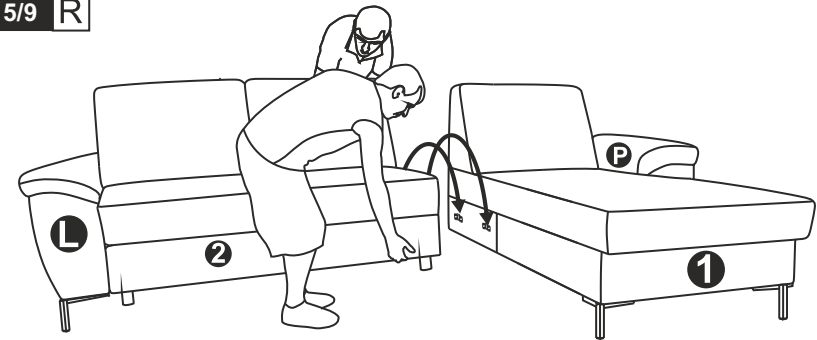

3/9 L

Die Kopfstütze ist als Zusatzoption erhältlich.  
Die entsprechenden Öffnungen sind immer vorhanden.

The headrest is available as an optional add-on.  
The corresponding openings are always present.

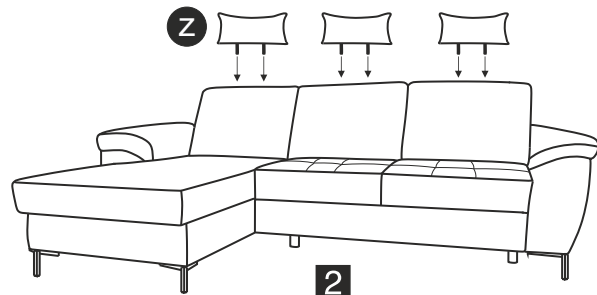

6/9 R

Die Kopfstütze ist als Zusatzoption erhältlich.  
Die entsprechenden Öffnungen sind immer vorhanden.

The headrest is available as an optional add-on.  
The corresponding openings are always present.

