

BOSTON

ART. NR.23000150 / 01

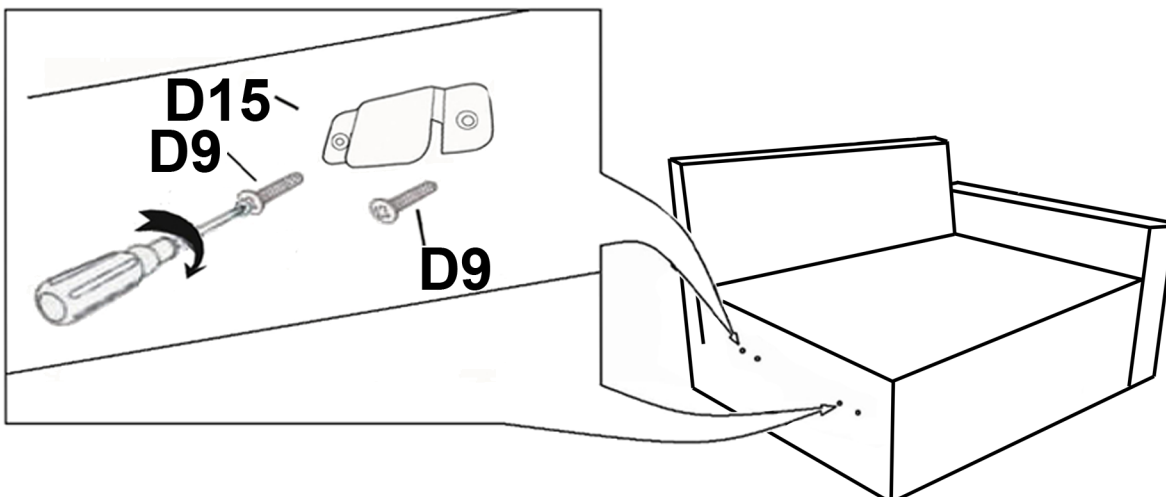

P

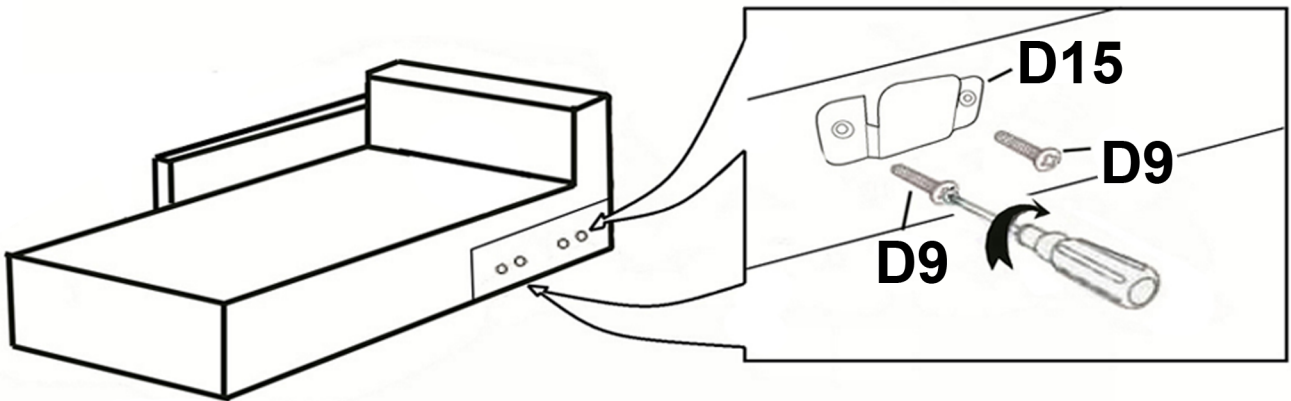
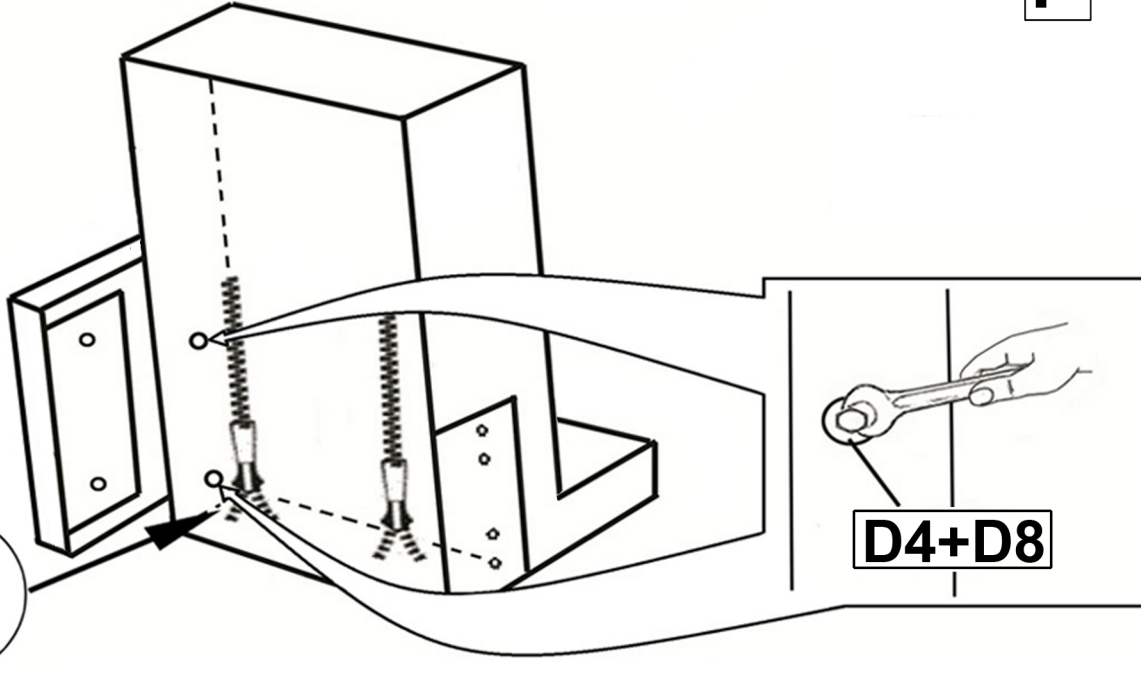
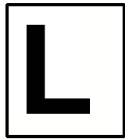
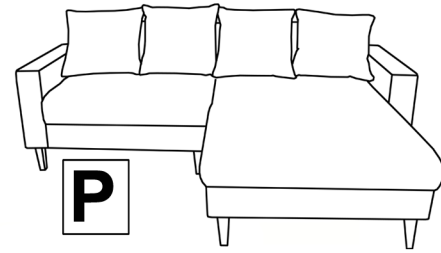
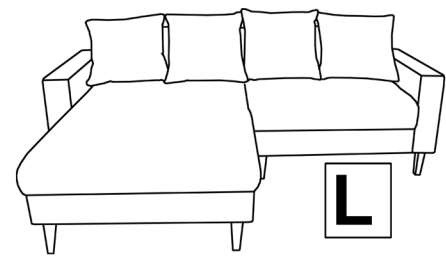
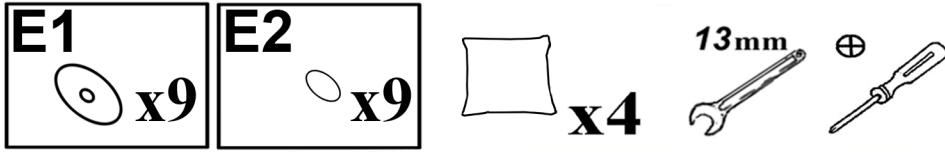
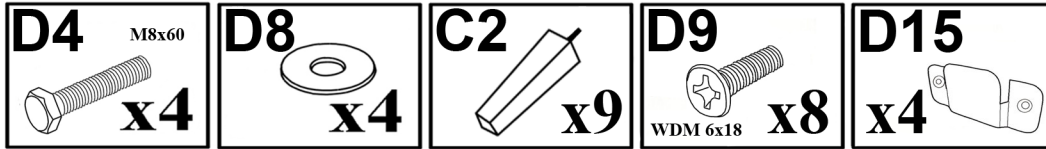
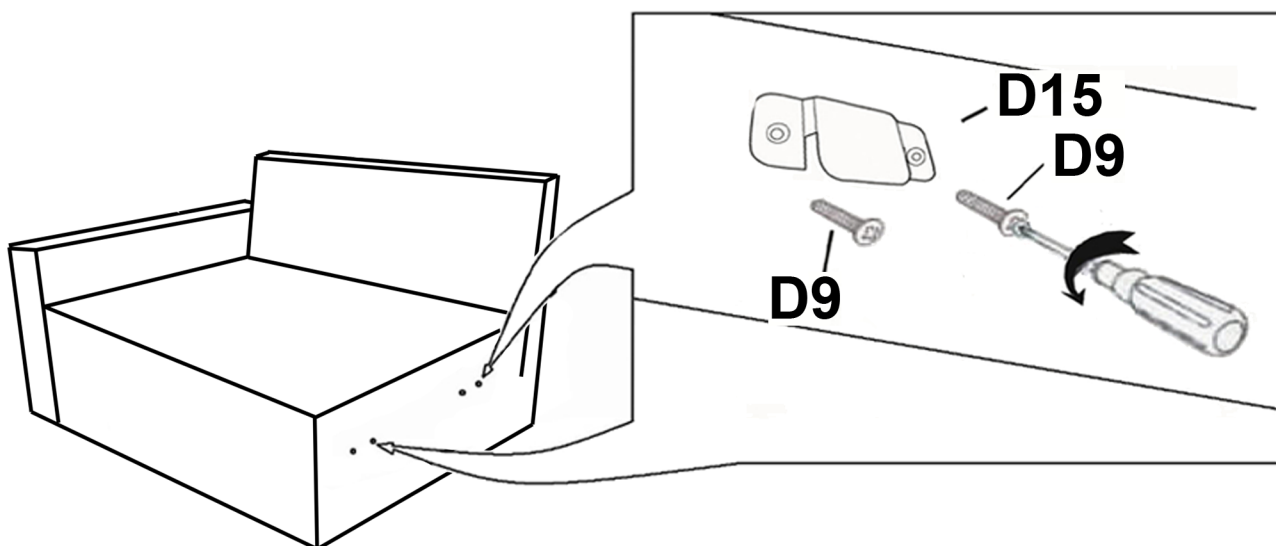
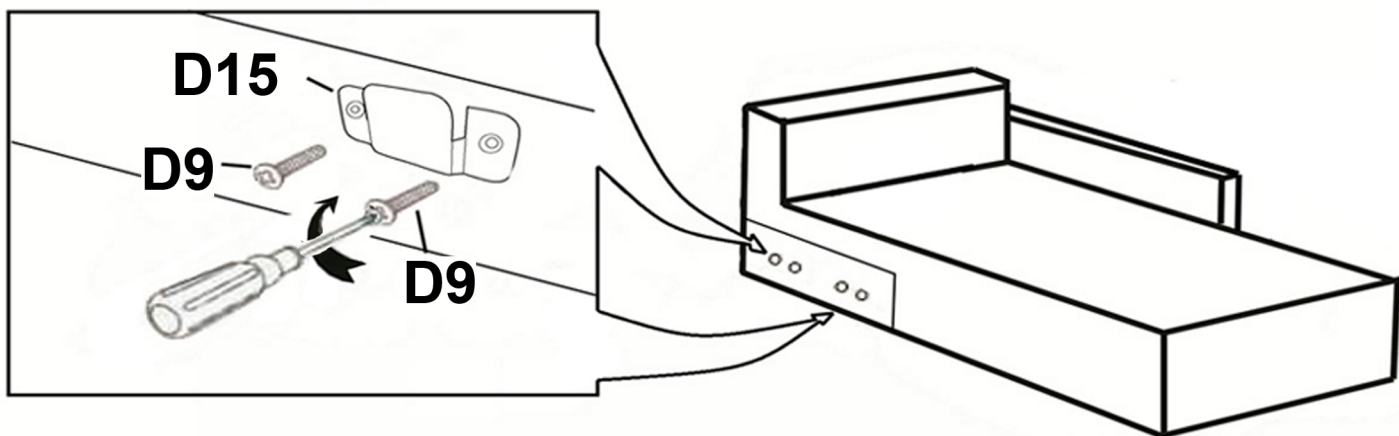
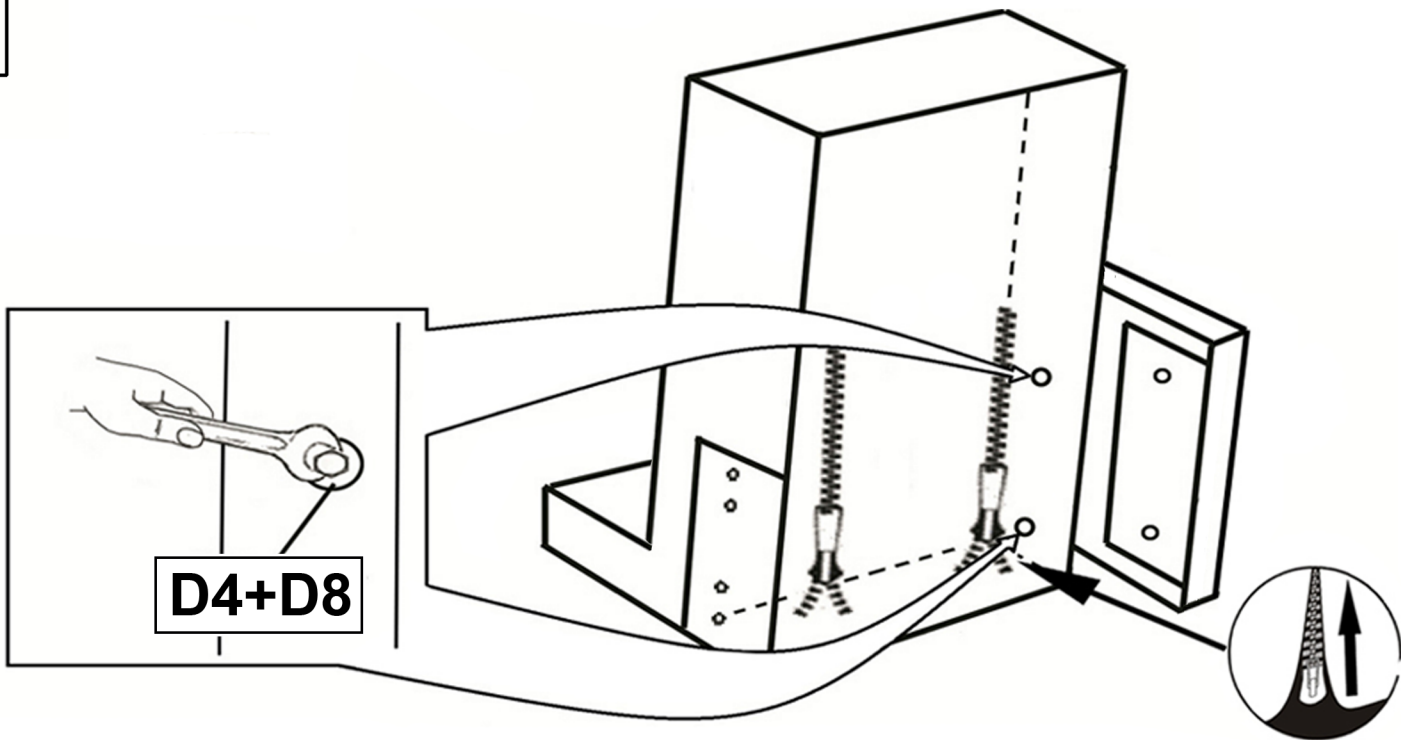

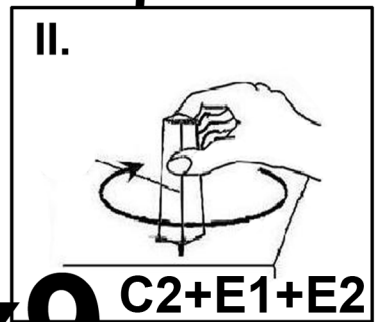
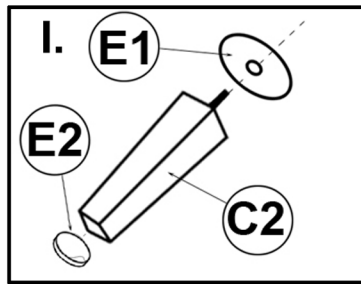
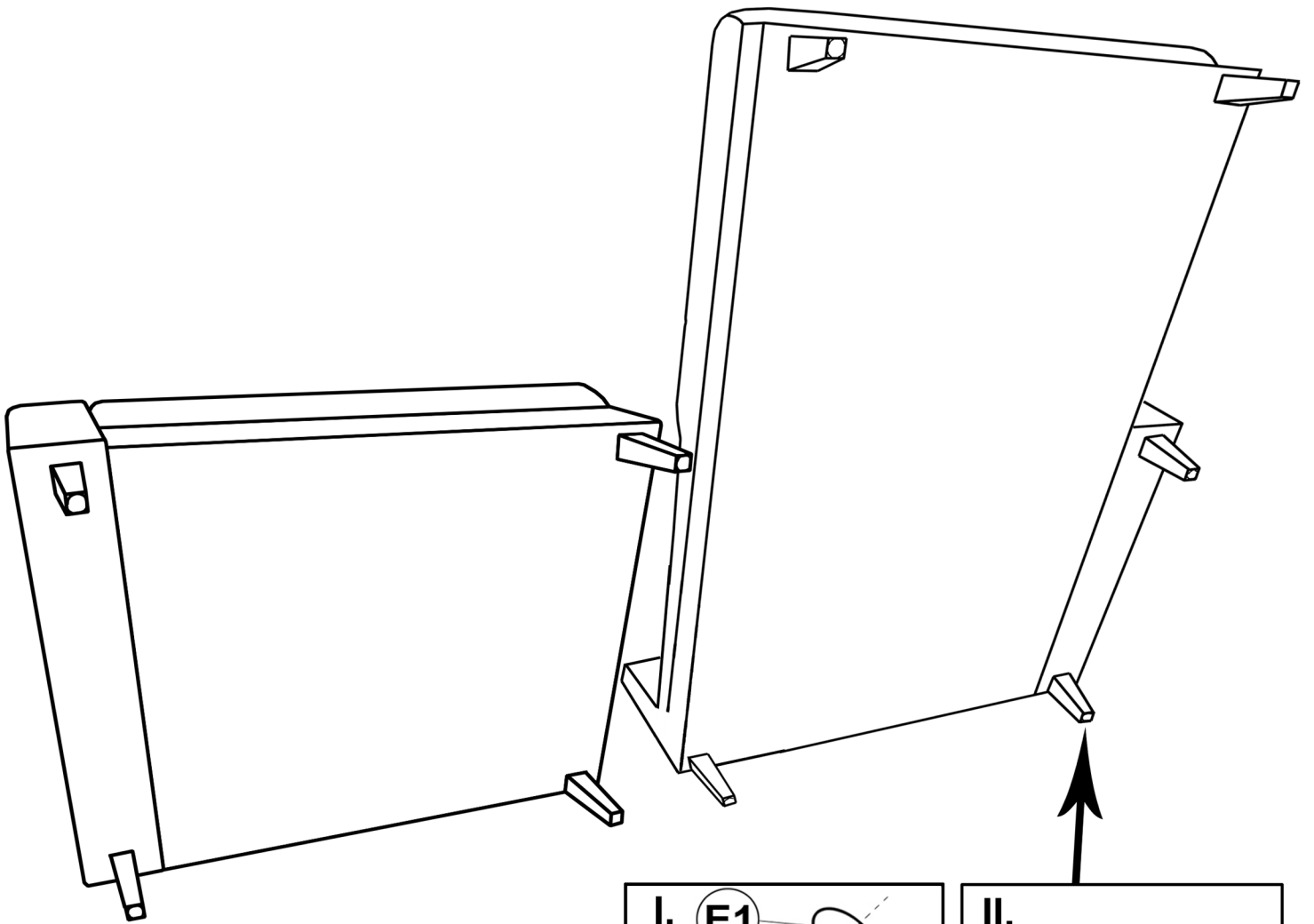

x9



