

7/9 LR

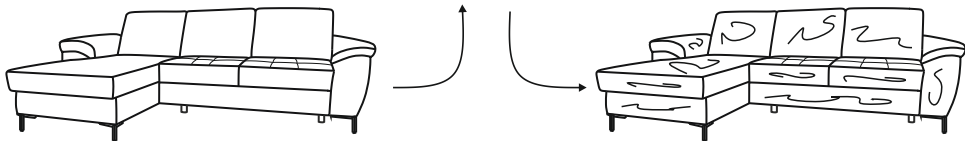

8/9 LR

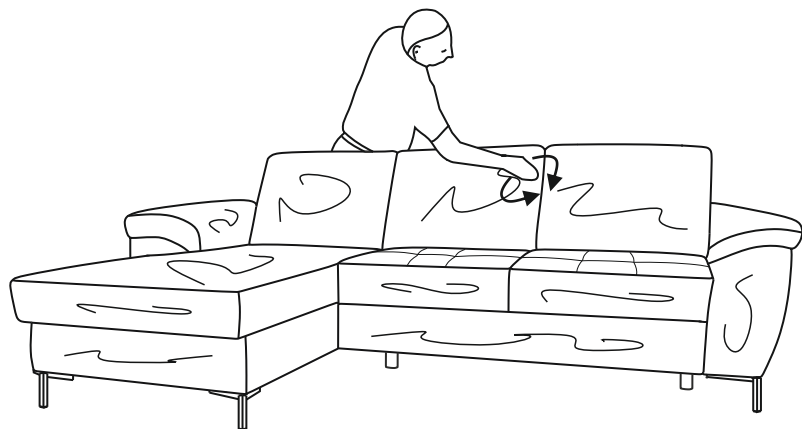

9/9 LR

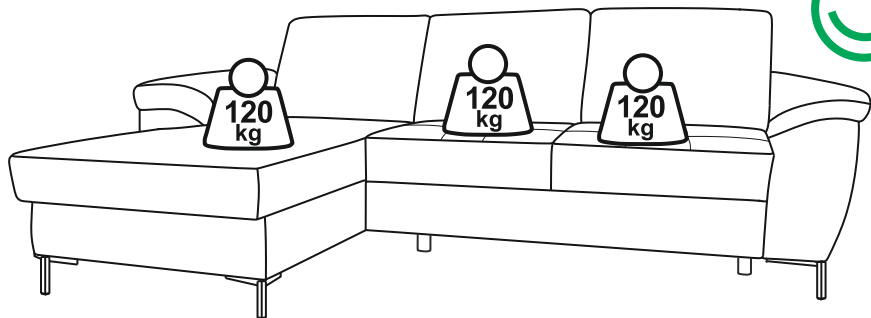

F.P.H. EUROMEBEL STYL-FENIKS TARTAK GRZEGORZ STRZODA
42-610 Miasteczko Śląskie
ul. Cynkowa 47
Polskakontakt@euromebelstyl.pl

Model: FOCUS L2

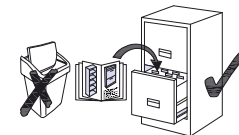
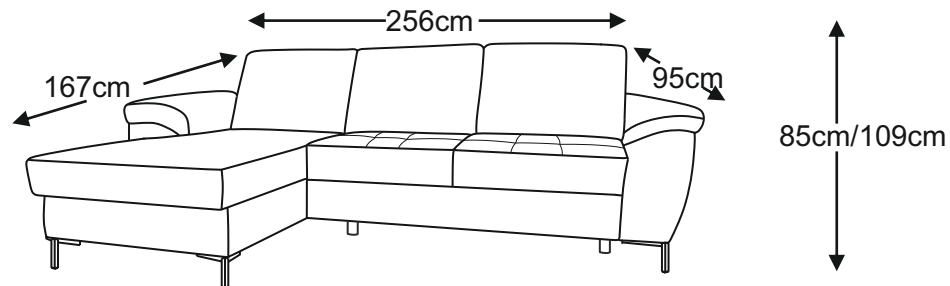

R

L

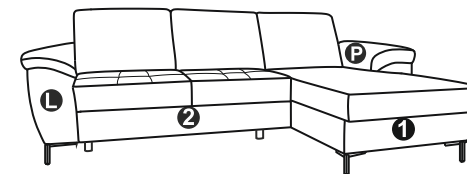
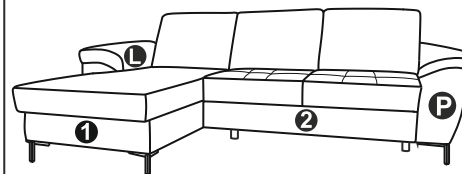

H110x40



H x4

Nr - 156 Black

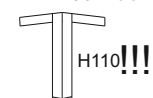

K x6

M6x20



J x18

Die Kopfstütze ist als Zusatzoption erhältlich.
Die entsprechenden Öffnungen sind immer vorhanden.

The headrest is available as an optional add-on.
The corresponding openings are always present.

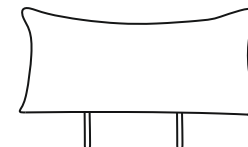

1/9 R

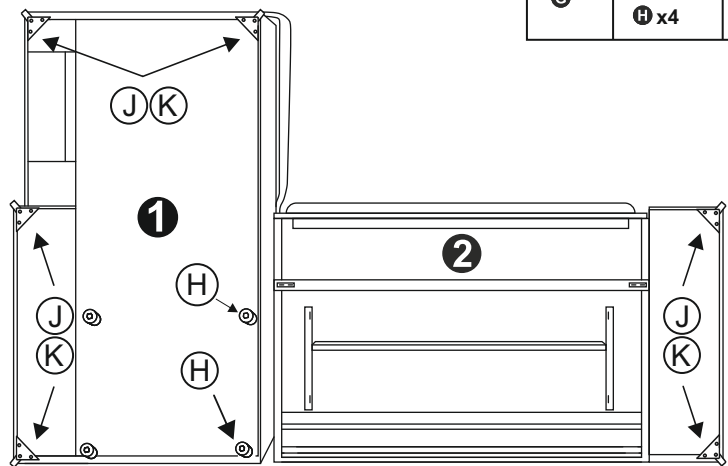
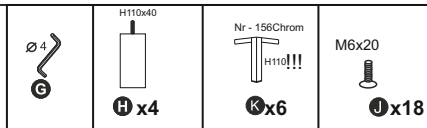

2/9 R

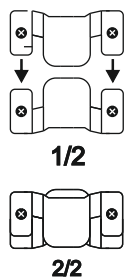
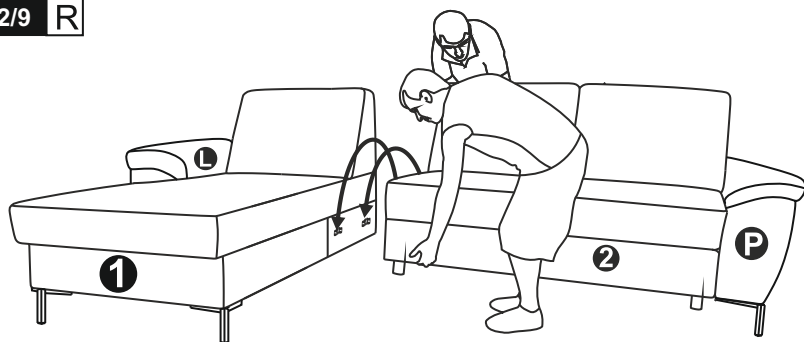

4/9 L

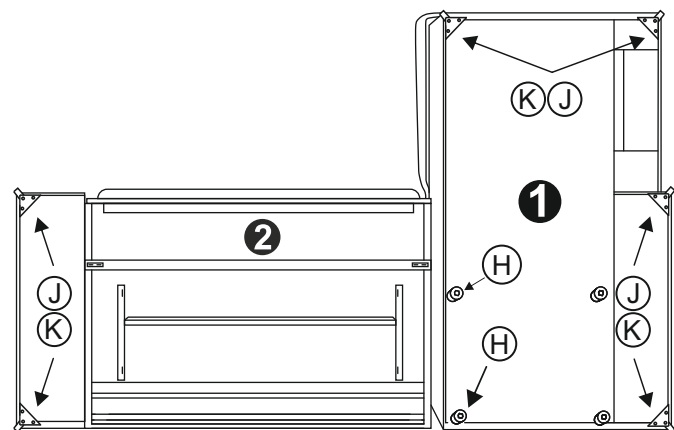
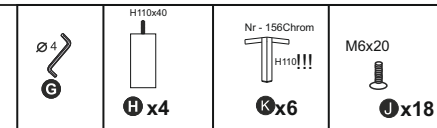

5/9 L

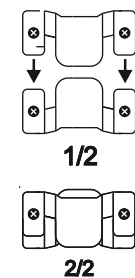
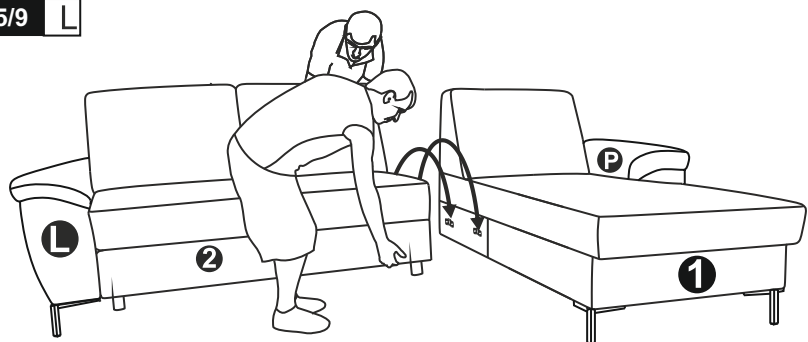

3/9 R

Die Kopfstütze ist als Zusatzoption erhältlich.
 Die entsprechenden Öffnungen sind immer vorhanden.

The headrest is available as an optional add-on.
 The corresponding openings are always present.

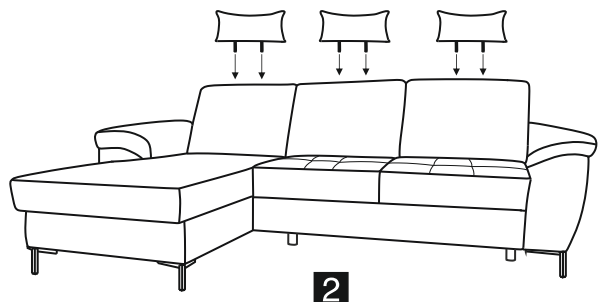

2

6/9 L

Die Kopfstütze ist als Zusatzoption erhältlich.
 Die entsprechenden Öffnungen sind immer vorhanden.

The headrest is available as an optional add-on.
 The corresponding openings are always present.

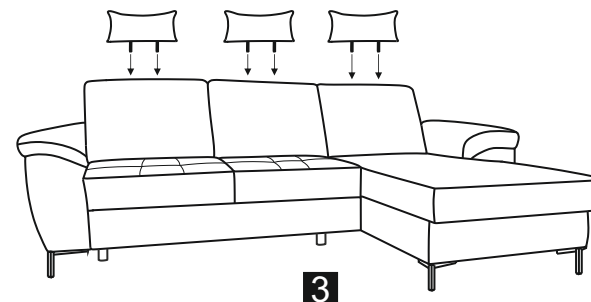

3