

# 17730004/01

XXXLutz KG  
Römerstraße 39  
A-4600 Wels

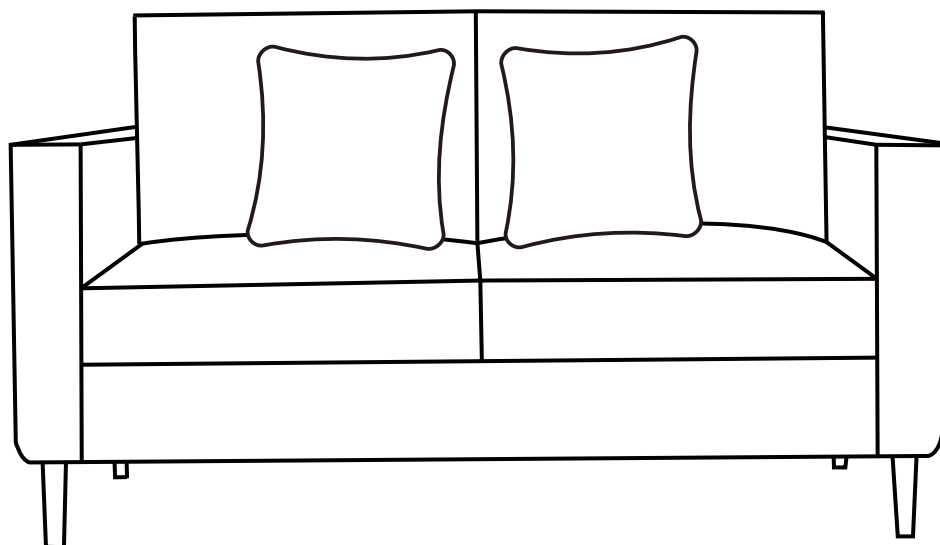

A	x1	B	x1	C	x1	D	x2	E	x2
F	x1	G	x1	H	x1	I	x4	K	x2



1

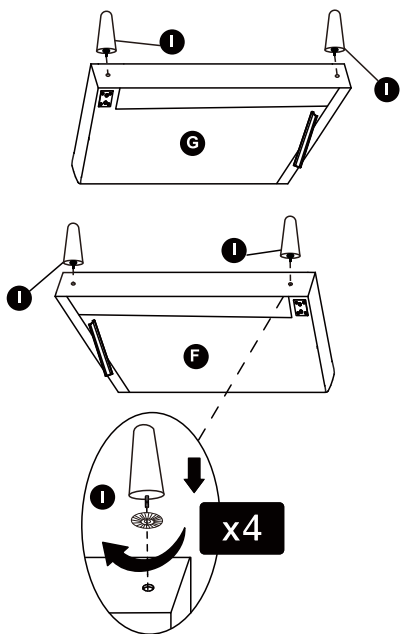

2

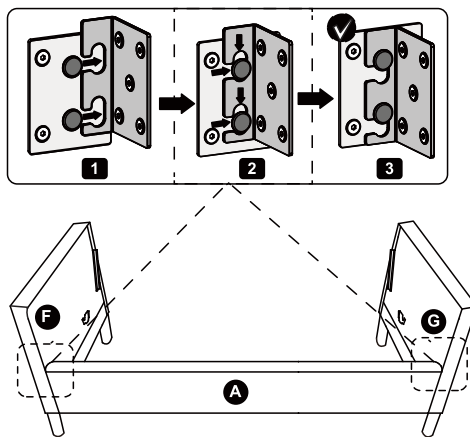

3

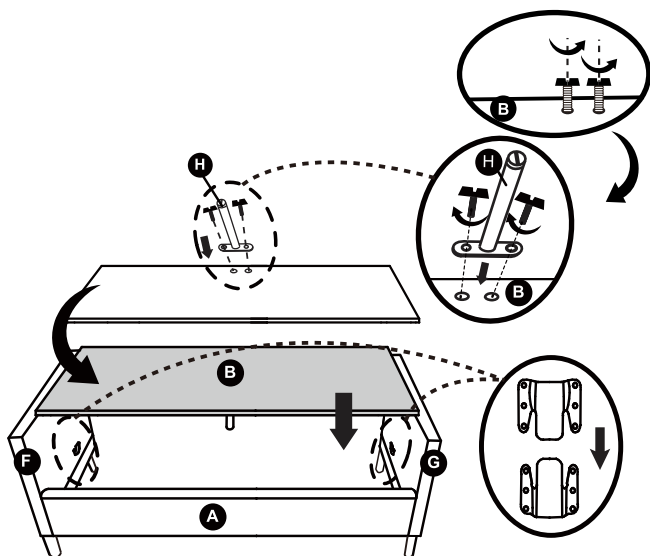

4

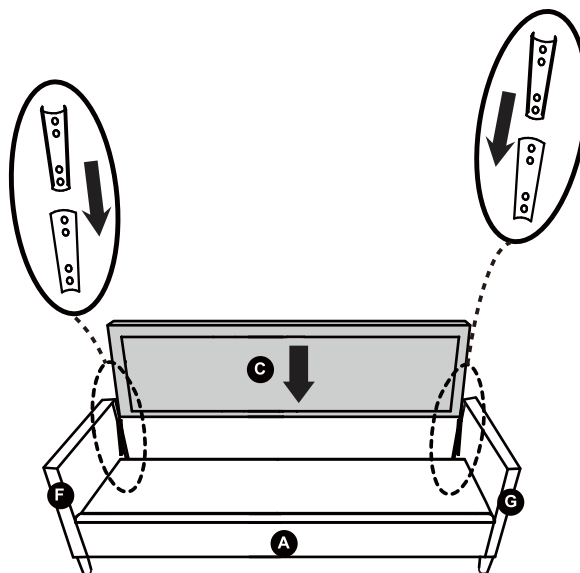

5

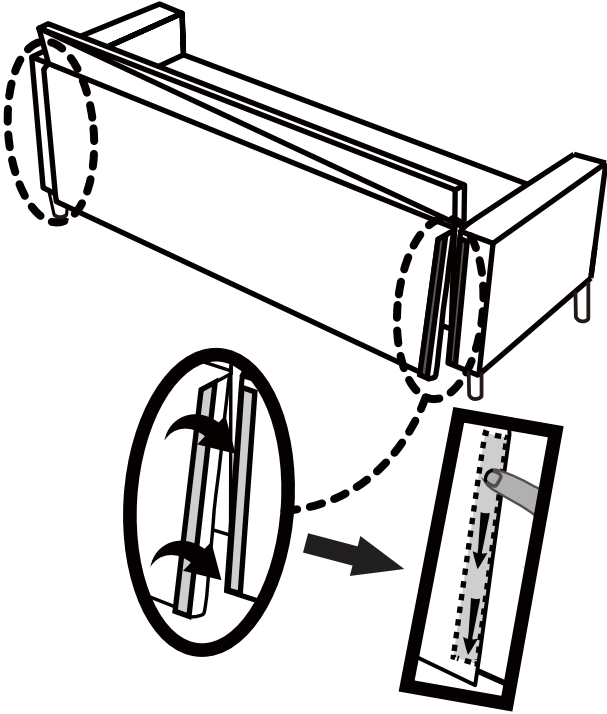

6

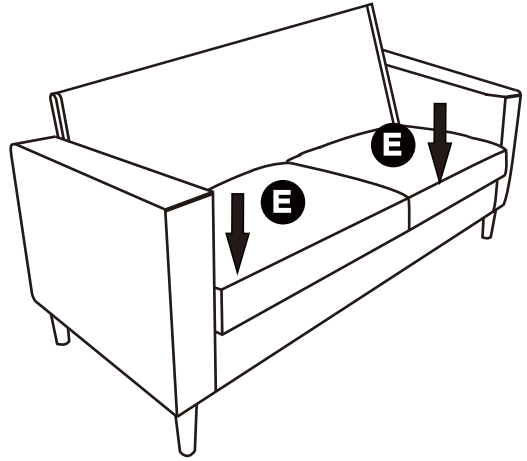

7

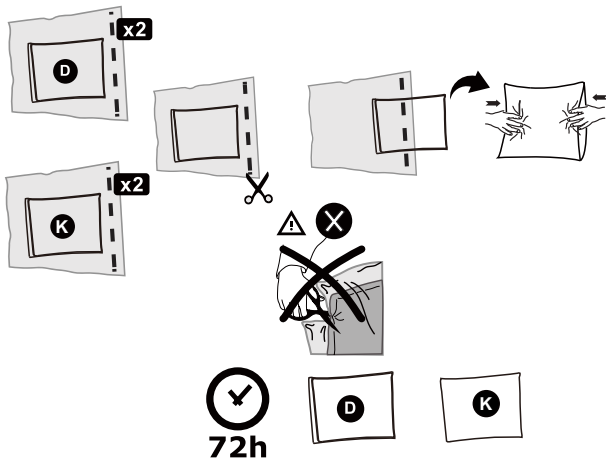

8

