

LASSE 4T 2SP

Art.-Nr.

15 550 195 - 07

↔	1800
↕	1965
↕	550
	[mm]

1 / 16
v0
37-2025

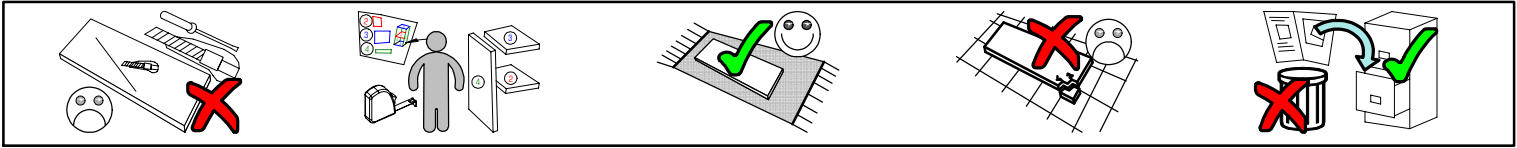
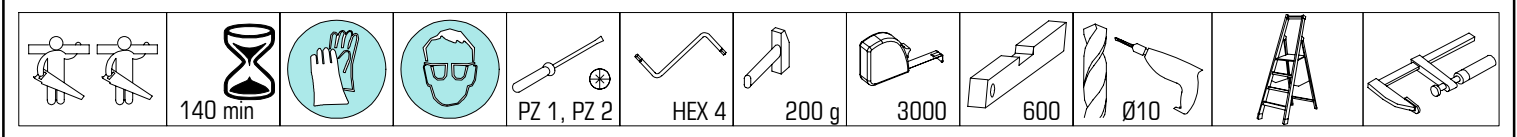



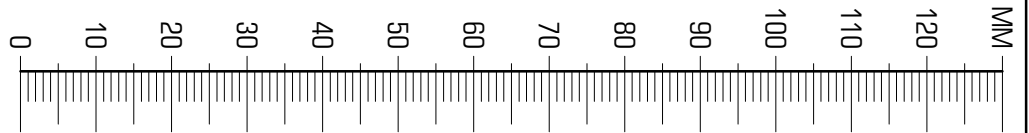
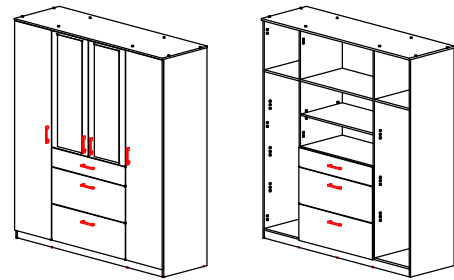
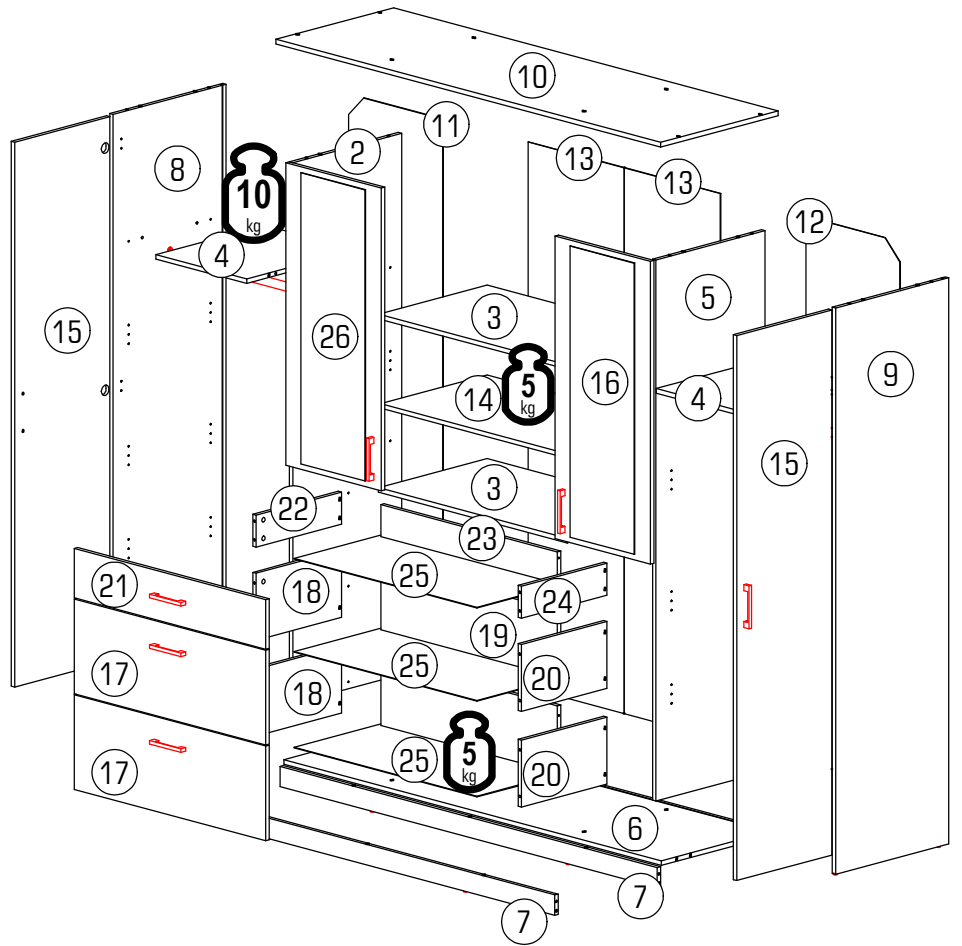

ID	ID	Image	Image	Image
22562	②	1859*510*16	1x	3/5
22563	③	884*509*16	2x	4/5
22316	④	425*509*16	2x	1/5
22317	⑤	1859*510*16	1x	3/5
22564	⑥	1766*528*16	1x	3/5
22565	⑦	1766*70*16	2x	5/5
22320	⑧	1945*529*16	1x	2/5
22321	⑨	1945*529*16	1x	2/5
22566	⑩	1800*550*16	1x	4/5
22323	⑪	1875*441*3	1x	2/5
22324	⑫	1875*441*3	1x	2/5
22325	⑬	1875*450*3	2x	2/5
22567	⑭	884*500*16	1x	5/5
22327	⑮	1872*446*16	2x	5/5
22328	⑯	1040*446*16	1x	1/5
22568	⑰	896*325*16	2x	4/5
22330	⑱	400*230*16	2x	1/5
22569	⑲	826*230*16	2x	5/5
22332	⑳	400*230*16	2x	1/5
22571	㉑	896*170*16	1x	4/5
22334	㉒	400*110*16	1x	1/5
22570	㉓	826*110*16	1x	4/5
22336	㉔	400*110*16	1x	1/5
22572	㉕	406*856*3	3x	1/5
22573	㉖	1040*446*16	1x	1/5

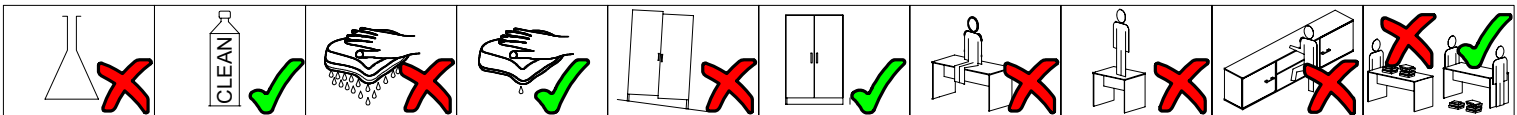

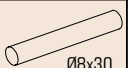
8402,03		Ø8	22255,00		Ø5,0x50	24101,00		Ø10	31103,00		22280,00		Ø4x30	32041,00		L=146	22243,00		Ø3,5x15	22244,01		Ø3,5x16	22300,00		Ø7x50
A	7x	B1	2x	B2	2x	B3	2x	C1	14x	C2	7x	D	56x	E	16x	F	24x								
22800,01		4	50563,00		34902,00		24008,00	3,0	27000,00		Ø8x30	22236,00		Ø2,5x16	22705,00		Ø6,8x8	30091,00		35101,95		4			
G	1x	H	16x	J	28x	K	32x	L	38x	M	32x	N	12x	P	8x	Q	4x								
36013,02		36013,02		70018,04		70013,01		Ø15x13	70021,01		70017,04		420	36002,07		36002,07		33008,00		400	33008,00		400		
R	4x	S	4x	T	4x	U	36x	V	36x	W	2x	X	6x	Y	6x	Z1	3x	Z2	3x						

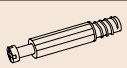

					
D 6x	L 4x	P 4x	T 2x	V 12x	Y 6x

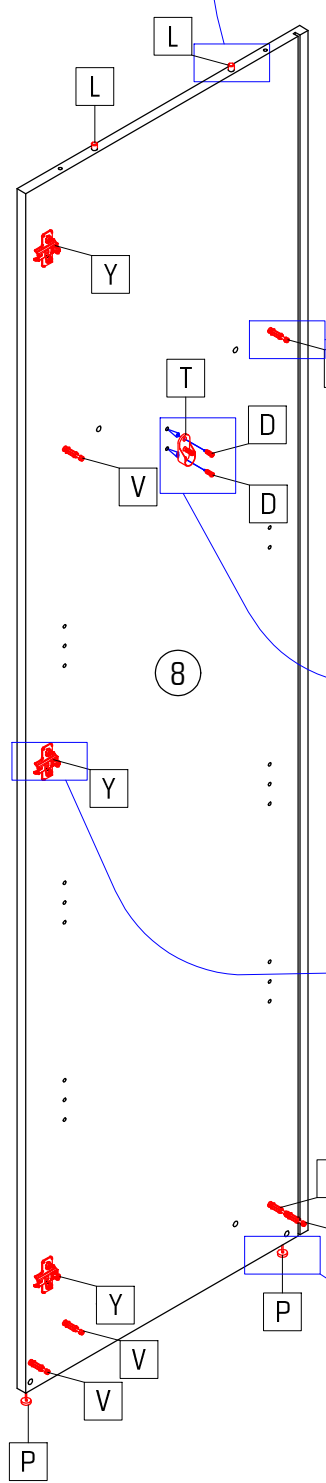
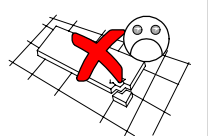
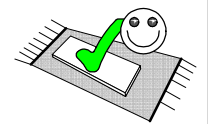
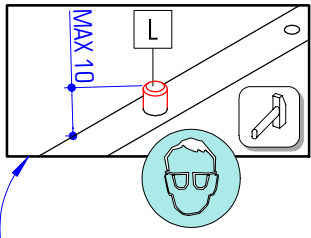
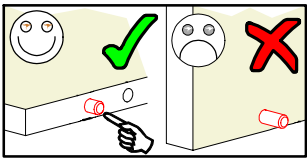

8

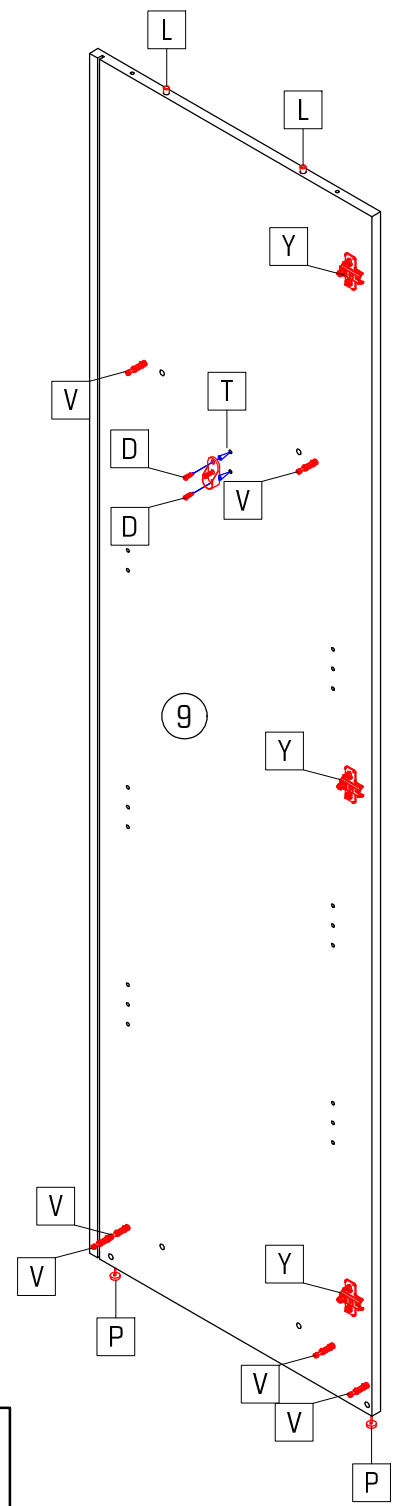
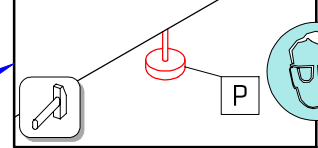
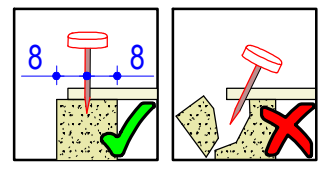
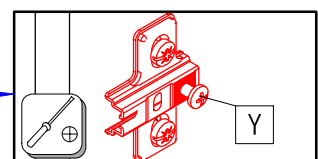
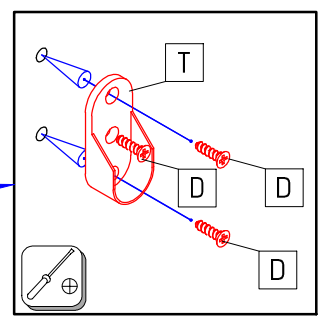
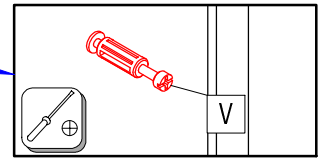
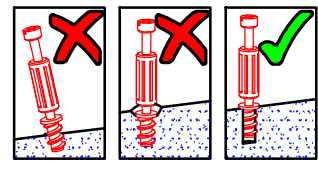

9



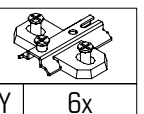

Y 6x



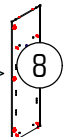
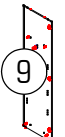



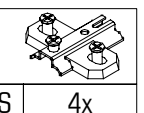



S 4x

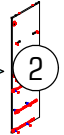
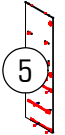

D 6x	L 2x	N 6x	Q 2x	S 2x	T 1x	V 6x	Z1 3x

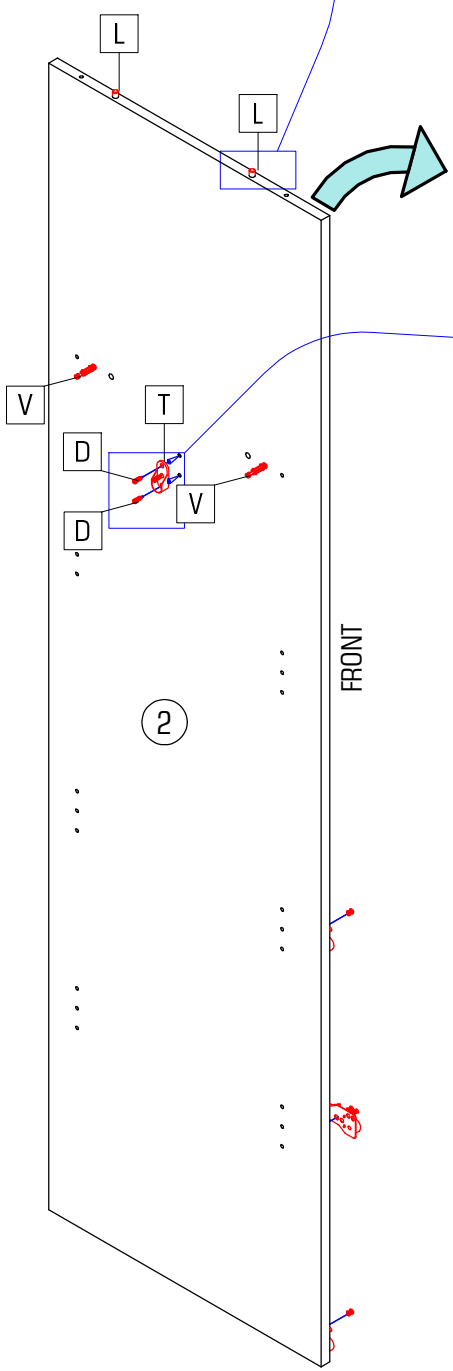
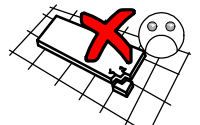
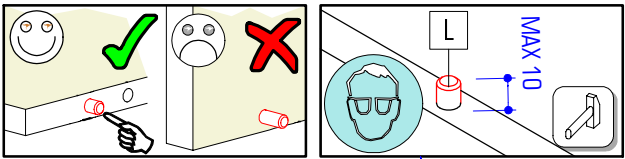
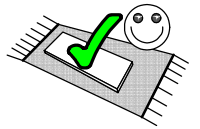

FRONT

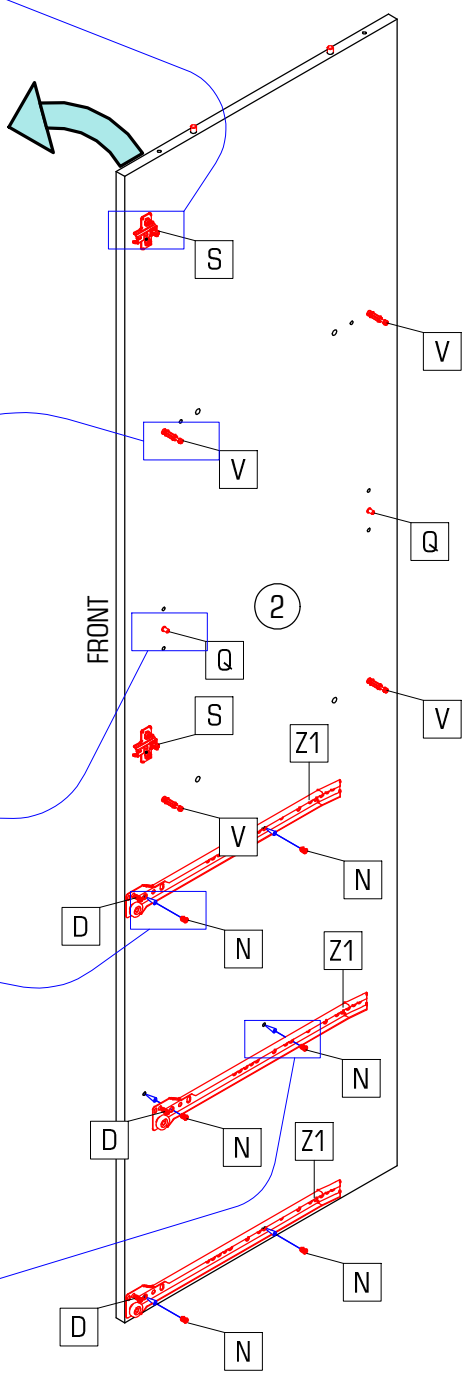
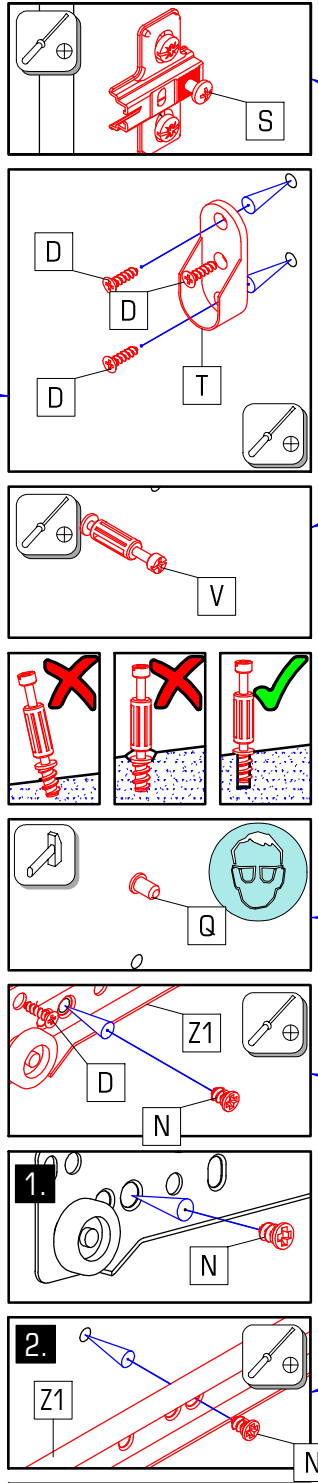

FRONT

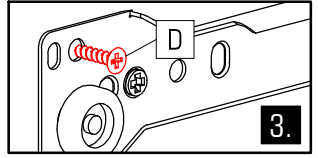
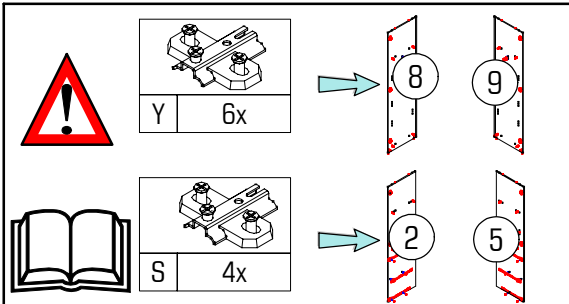

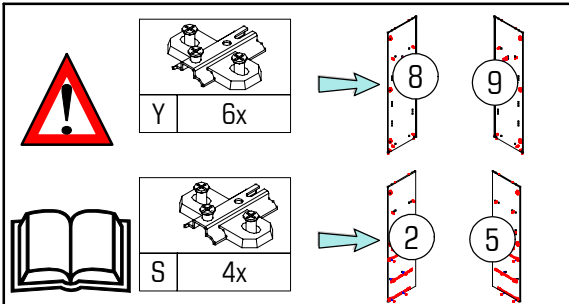
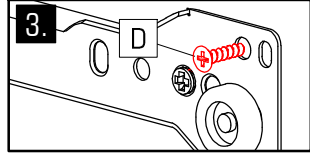
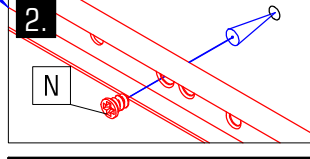
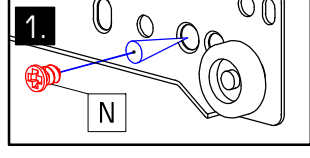
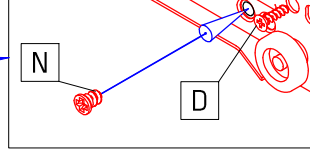
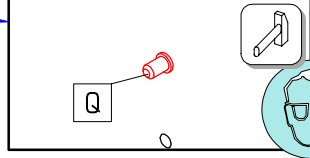
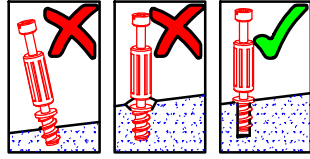
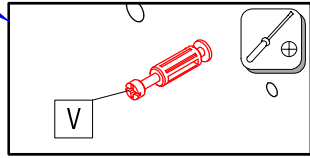
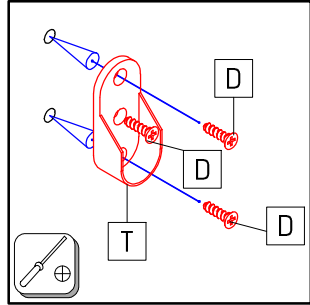
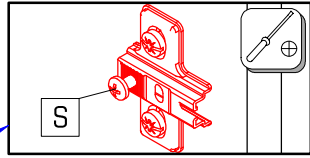
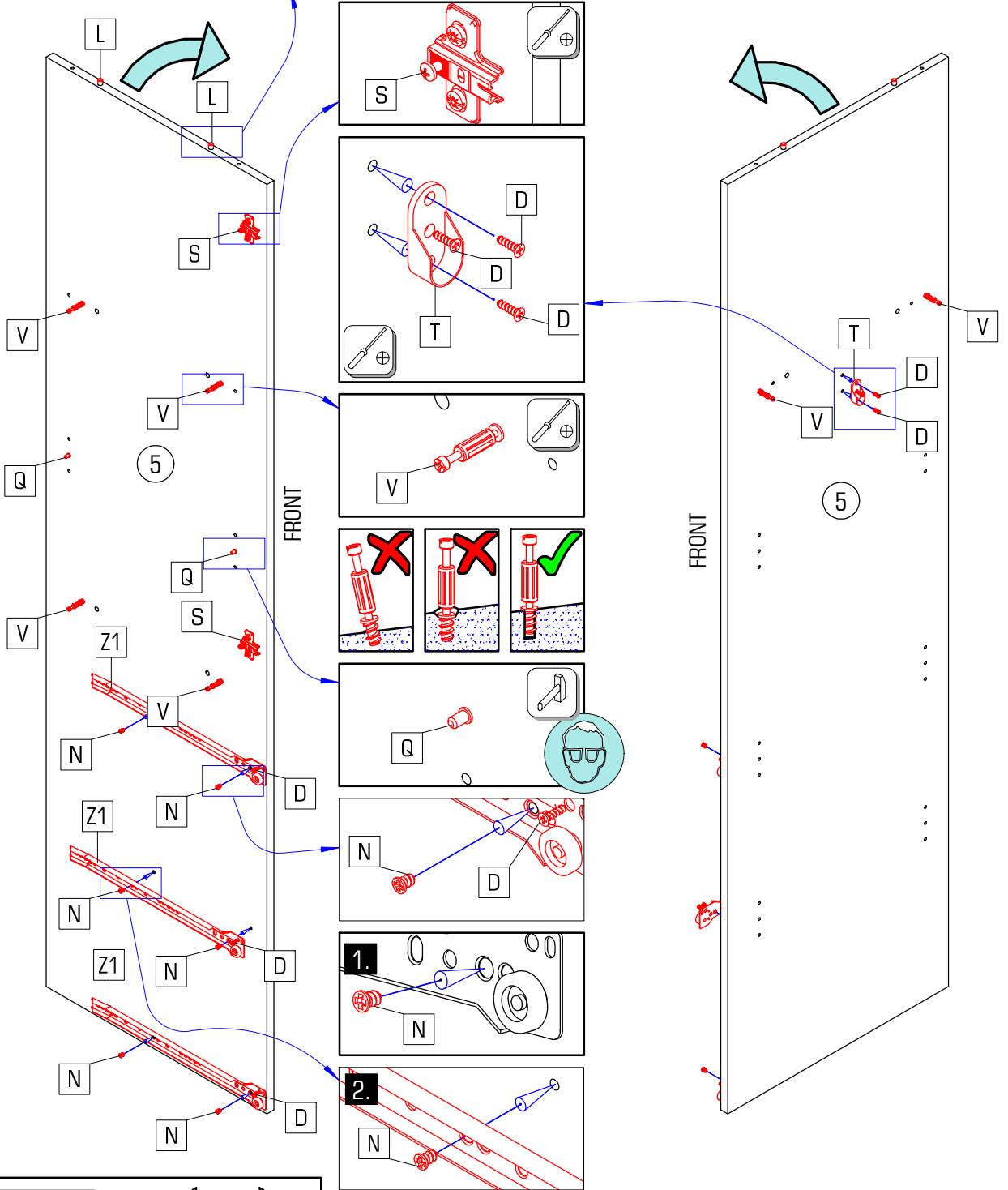
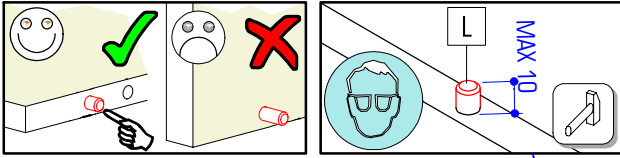
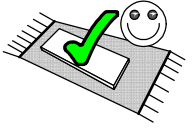
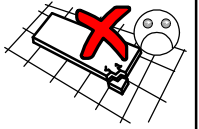

D 6x	L 2x	N 6x	Q 2x	S 2x	V 6x	T 1x	Z1 3x

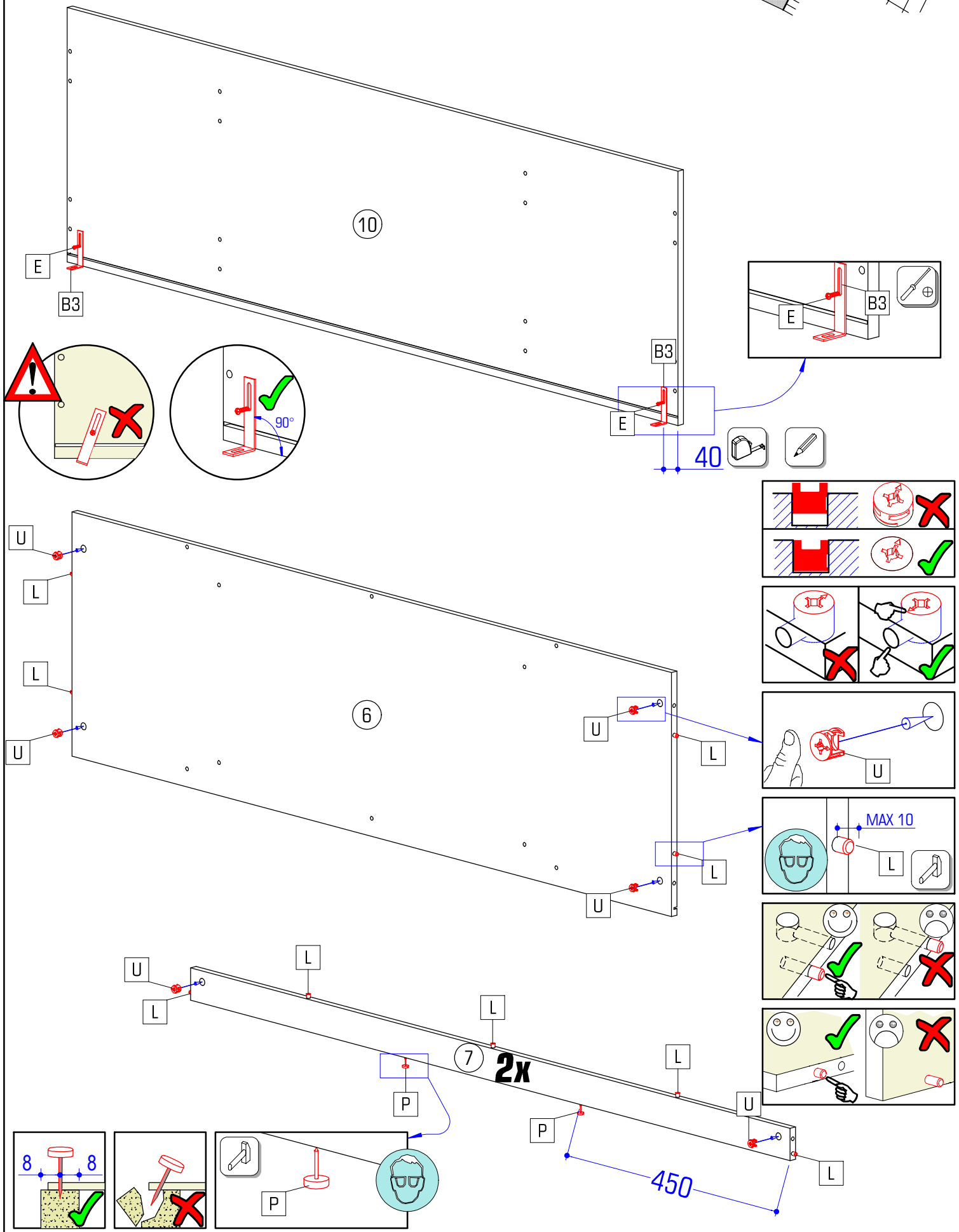
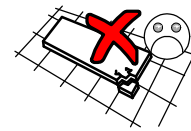
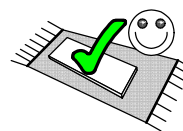

B3	Ø3,5x16	Ø8x30		Ø15x13
2x	2x	14x	4x	8x

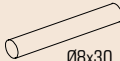

	$\varnothing 8 \times 30$		$\varnothing 15 \times 13$
L	16x	U	16x

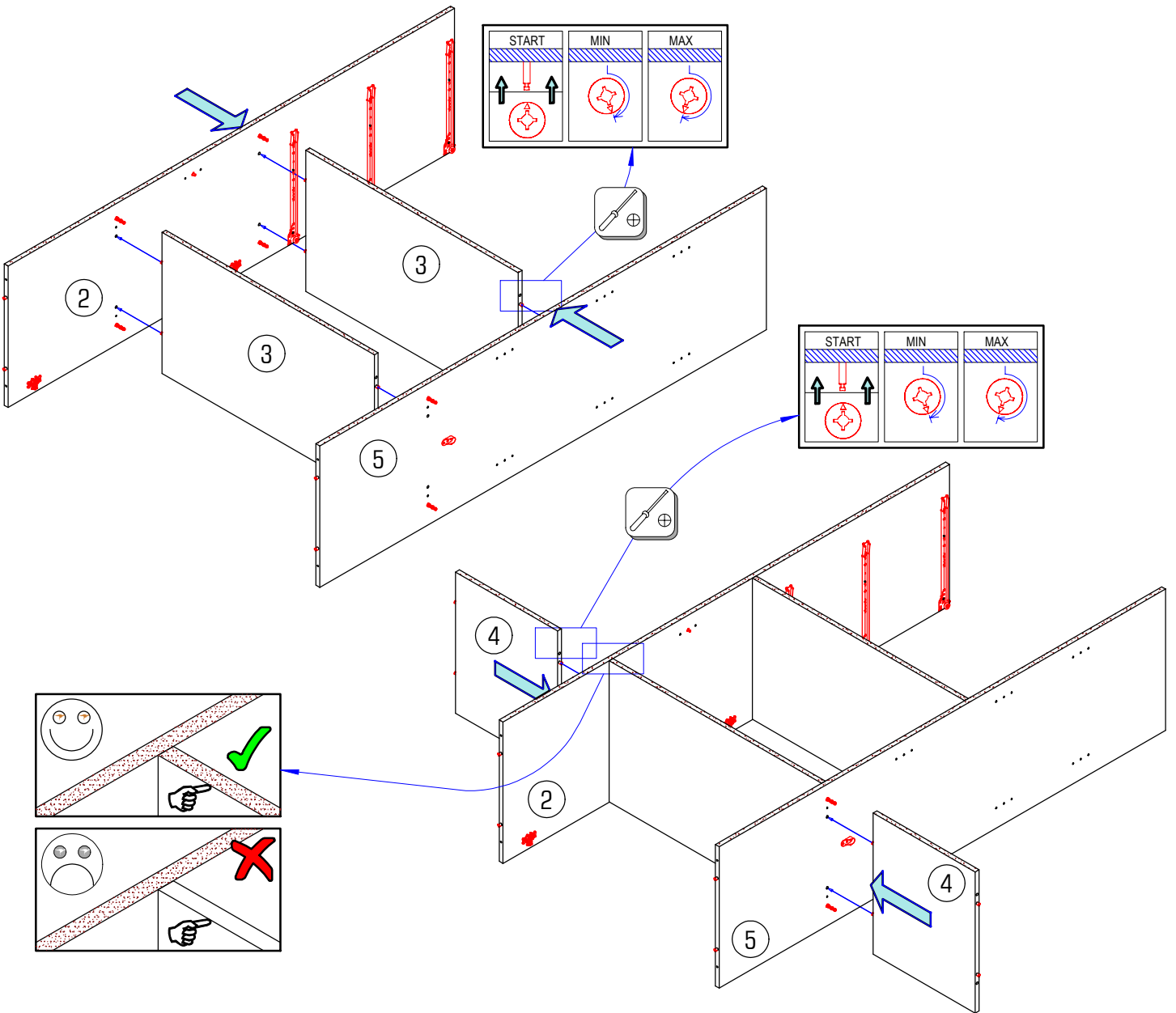
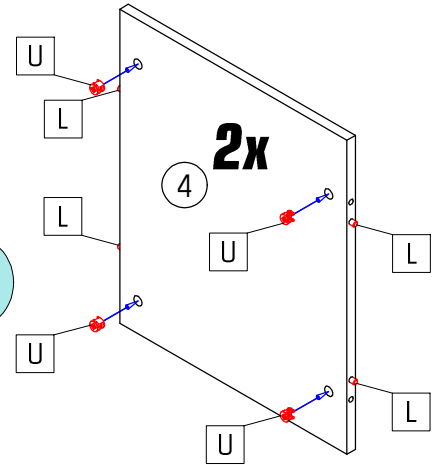
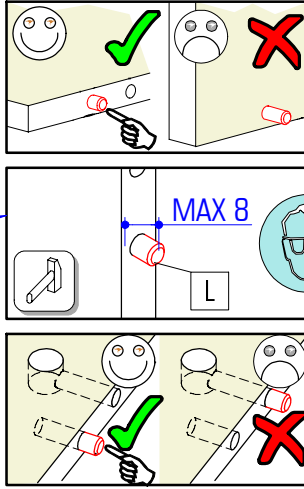
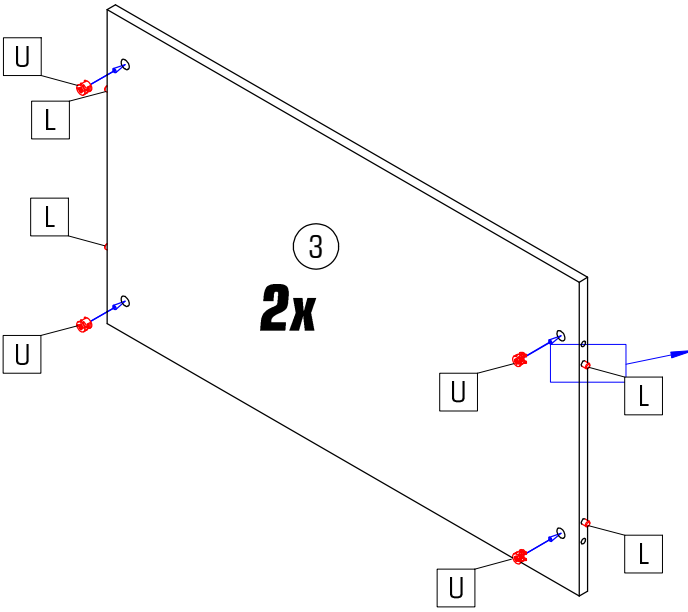
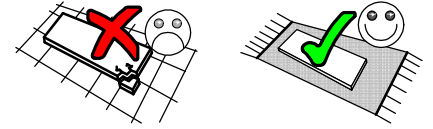

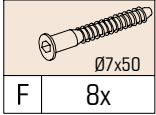



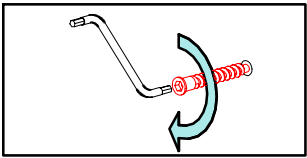
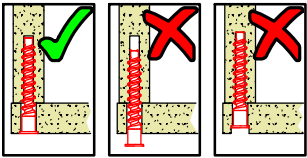
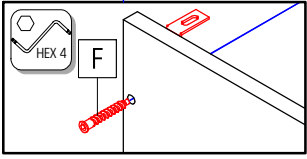
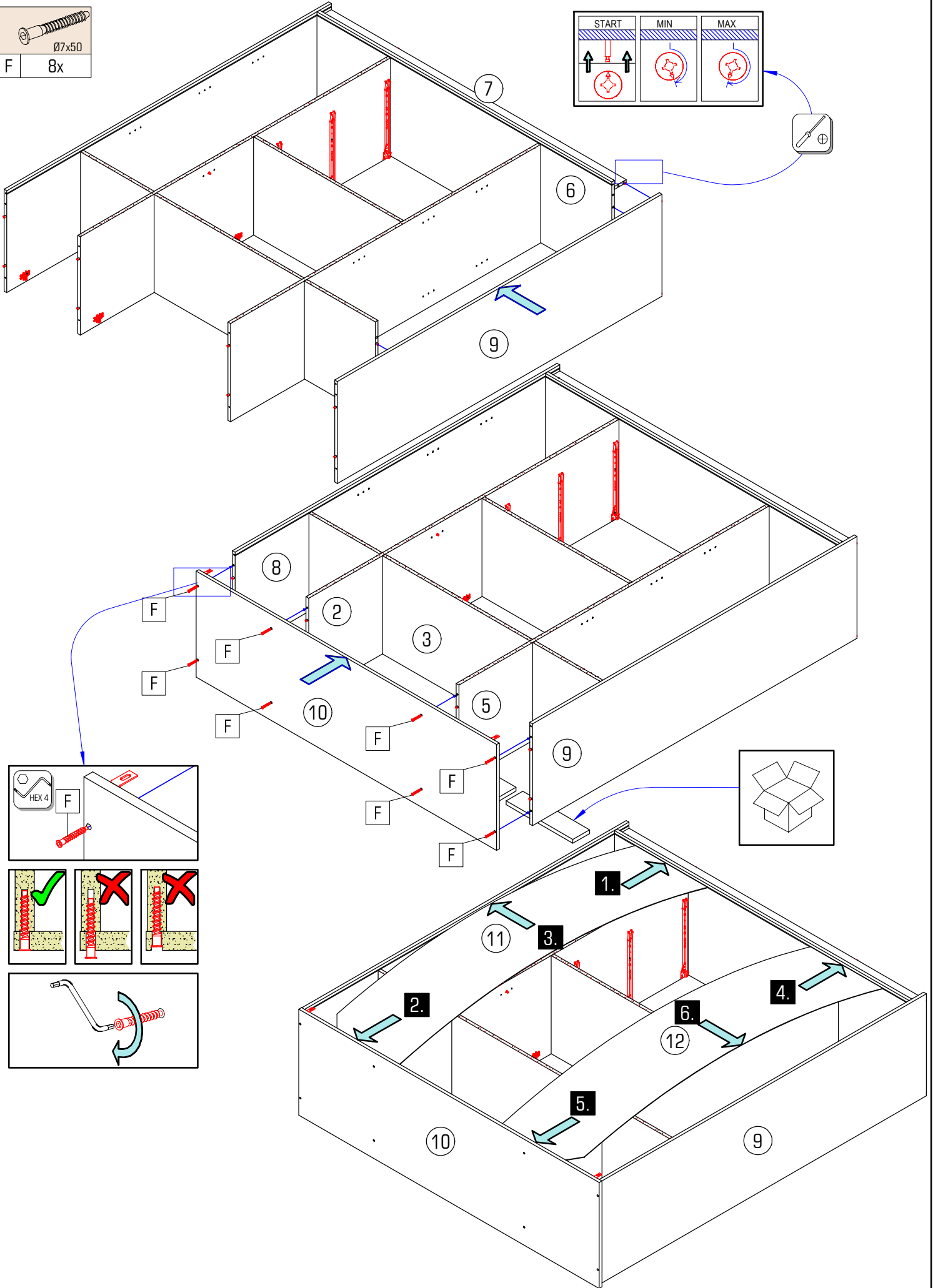
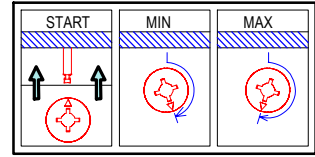

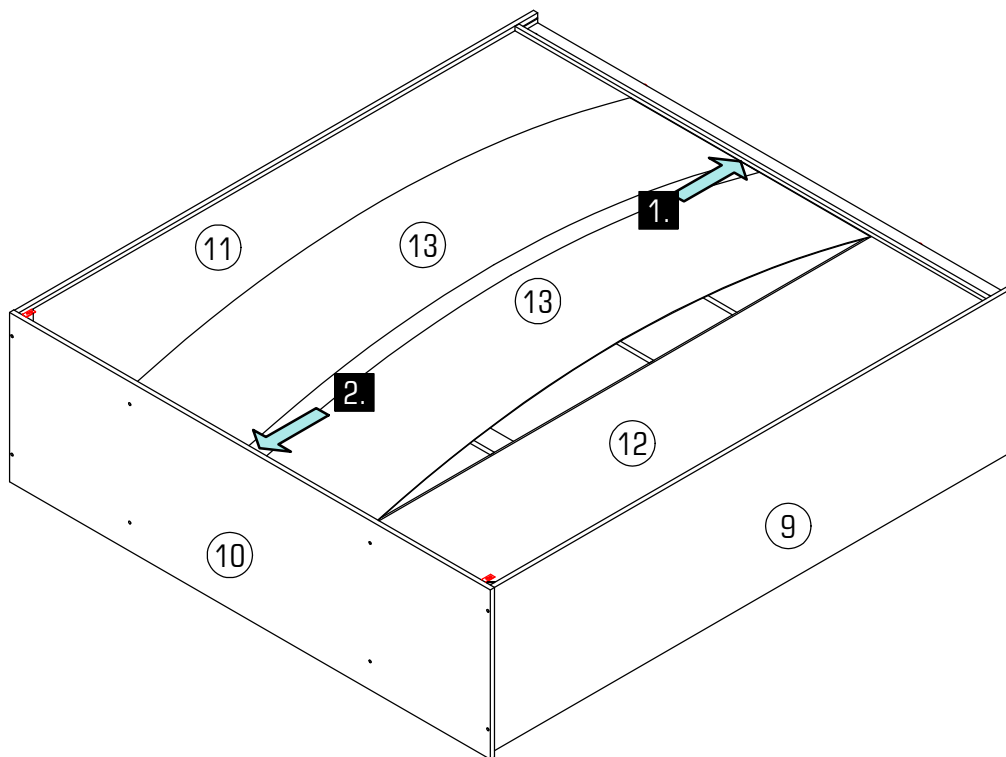

F 8x

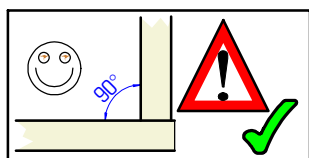
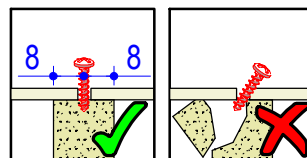
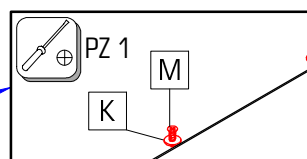
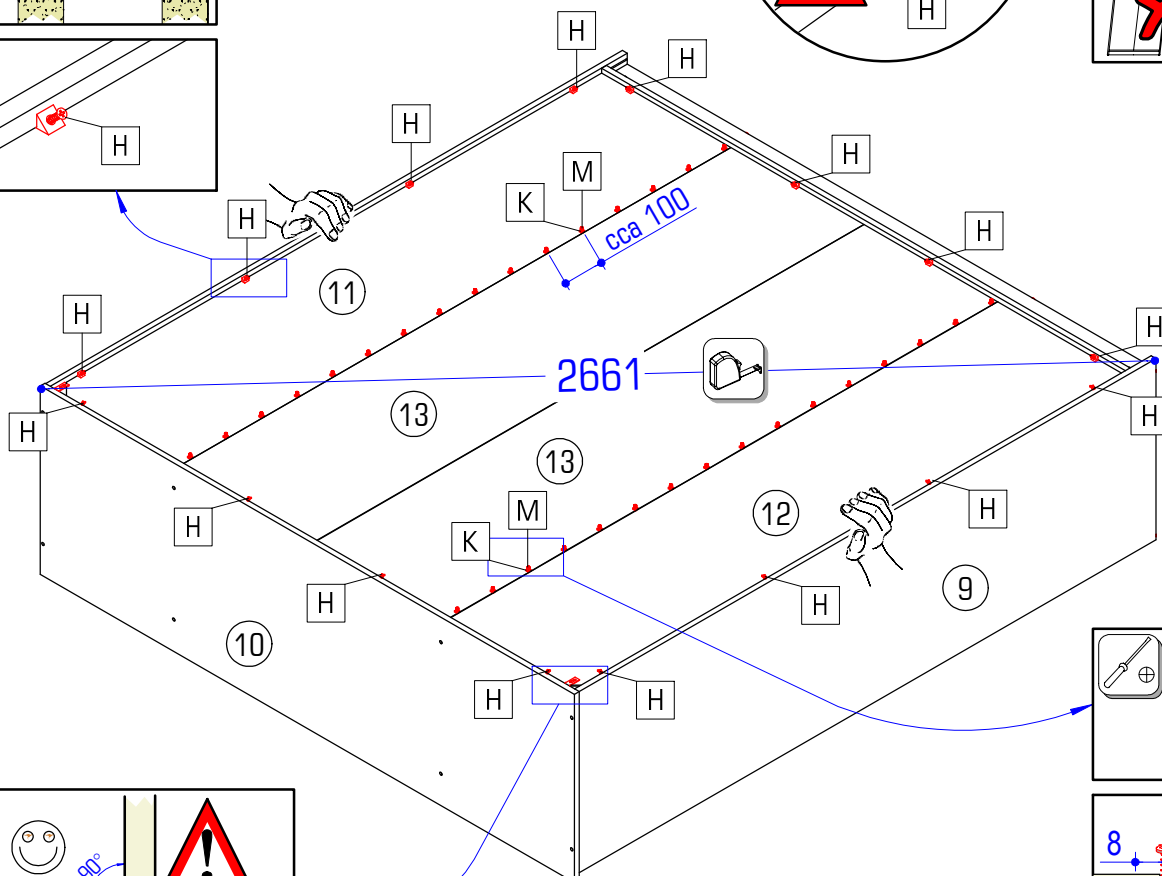
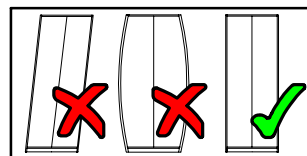
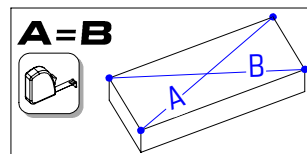
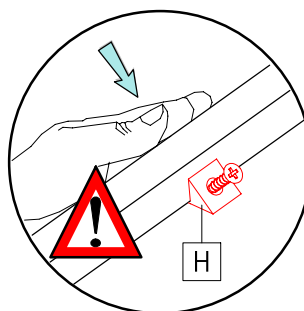
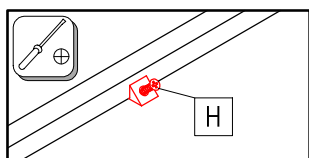
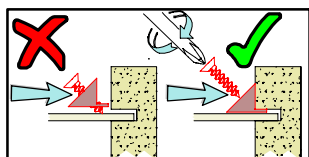



H 14x	K 32x	M 32x
	3,0	Ø2,5x16



				
Ø5,0x50	Ø10	Ø3,5x16	420	
B1	2x	B2	2x	E
				2x
			W	2x
				J
				16x

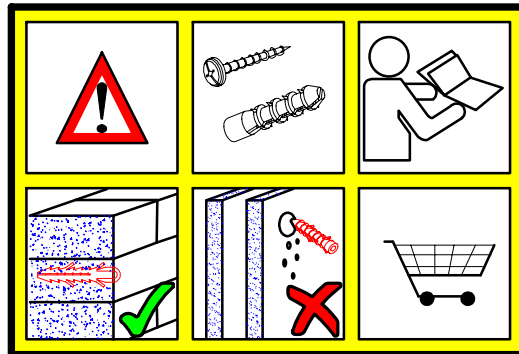
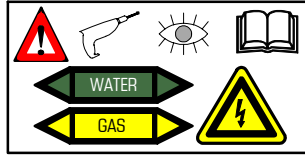
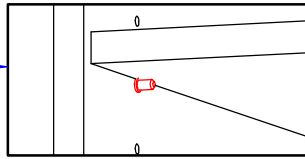
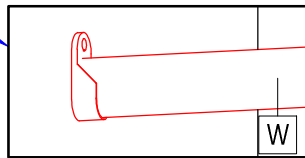
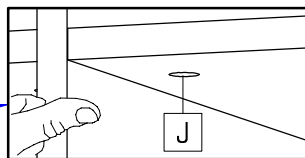
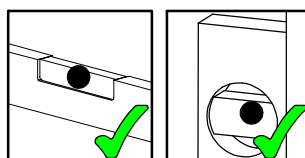
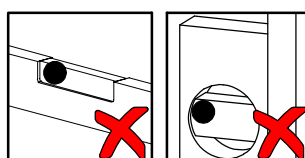
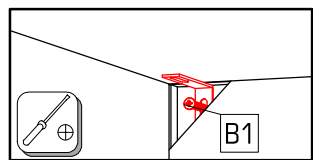
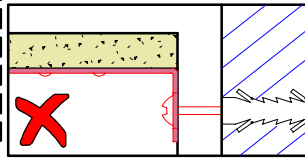
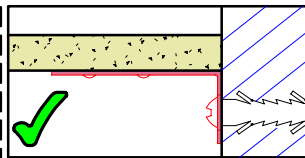
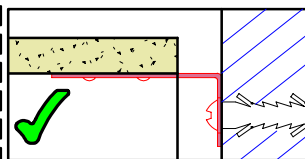
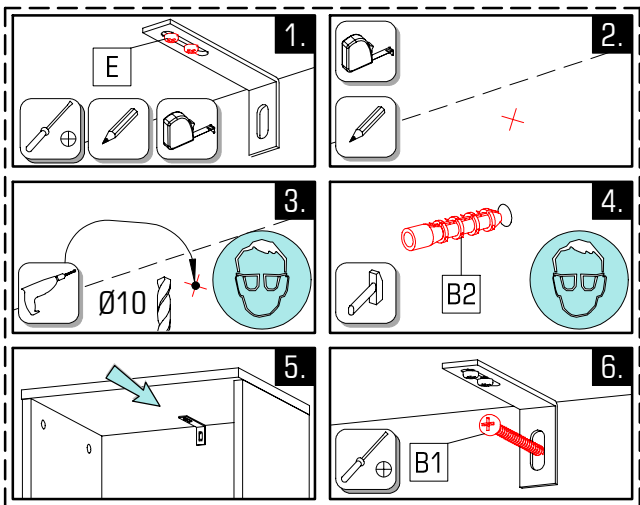

PL Uwaga! Ścianę należy sprawdzić przed montażem. Dołączona uniwersalna kołki rozporowe są odpowiednie tylko do stosowania w mocnych murach, takich jak beton lub cegła. Nie rób za pomocą kołków ozporowych murowanych, takich jak pustak, lekka kostka, powierzchnie takie jak płyty gipsowo-kartonowe lub inne systemy ram. Jeśli dotyczy, muszą to być określone kołki rozporowe być użyty! Są one dostępne w specjalistycznym sklepie niezgodność, producent / sprzedawca lub importer nie ponoszą odpowiedzialność.

DE Achtung! Die Wandbeschaffenheit ist vor der Montage unbedingt zu prüfen. Die beigelegten Universaldübel sind ausschließlich nur zur Verwendung für festes Mauerwerk wie Beton/Ziegel. Die Mauerdübel dürfen nicht bei Mauerwerk wie Hohlraumziegel, Leichtbausteinen, Gipskartonplatte oder anderer Rahmenbauweise verwendet werden. Bei diesen Mauerwerken sind gegebenenfalls Spezialdübel zu verwenden! Diese sind in einem Fachgeschäft erhältlich. Bei Nichterhaltung wird seitens Produzenten/Händler und Importeur keine Haftung übernommen.

EN Caution! The wall must be examined before assembly. The included universal wall plugs are only suitable for using in firm masonry such as concrete block or brick. Do not using the wall plugs masonry such as hollow brick, lightweight block, surfaces such as gypsum plasterboard or other framing systems. If applicable, particular wall plugs must be used! These are available at a specialised store (hardware store). In case of non-compliance, the manufacturer/retailer or importer do not assume liability.

RO Prudență! Zidul trebuie examinat înainte de asamblare. Prilezele de perete sunt adecvate numai pentru utilizarea în zidărie fermă, cum ar fi betonul bloc sau cărămidă. Nu folosiți zidărie de perete, cum ar fi caramida goală, blocul ușor, suprafețe cum ar fi gips-carton sau altă încadrare sisteme. Dacă este cazul, trebuie folosite anumite prize de perete! Acestea sunt disponibile la un magazin specializat (magazin de hardware). În caz de nerespectare, producătorul / vânzătorul cu amănuntul sau importatorul nu își asumă răspunderea.

HR Pažnja! Prije montaže obvezno provjerite svojstvo zida. Priložene univerzalne tiplje namijenjene su isključivo za masivne zidove od betona/opeke. Tiplje za masivne zidove ne smiju se koristiti za zidove kao npr šupljina opeka laki sastavni elementi, gips-kartonske ploče ili drugi modularni načini gradnje. Za te zidove potrebne su eventualno posebne tiplje! Iste su dostupne u specijaliziranim trgovinama građevinskim materijalom. U slučaju nepridržavanja prethodno navedenih napomena, proizvođač/trgovac i uvoznik ne preuzimaju odgovornost!

CZ Upozornění! Před montáží je nutné zkontrolovat stav stěny. Přiložené univerzální hmoždinky jsou určeny pouze k použití pro pevné zdivo jako beton/cihly. Hmoždinky do zdi se nesmí používat u dutinová cihla, zdiva jako pórovitý stavební kámen, sádrokartonová deska nebo jiný měkký materiál. U těchto zdiv jsou nutné použít speciální hmoždinky! Jsou k dostání v speciálních prodejních se stavebním materiálem. Při nedodržení těchto pokynů výrobce/prodejce a dovozce neručí za způsobené škody.

SI Pozor! Pred montažo preverite stanje stene. Priloženi univerzalni mozniki so izključno samo za uporabo na žvrstnem zidovju, kot sta beton in opeka. Stenski mozniki se ne smejo uporabljati pri zidovju kot so votlina opeke, zidaki za lahko gradnjo, mavčne plošče ali druge okvirne gradnje. Pri teh zidovjih morate v danih primerih uporabljati posebne moznike. Ti so na voljo v specializiranih trgovinah (trgovinah z gradbenim materialom) Pri upoštevanju se s strani proizvajalca/trgovca in uvoznika ne prevzame jamstvo.





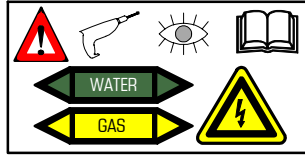
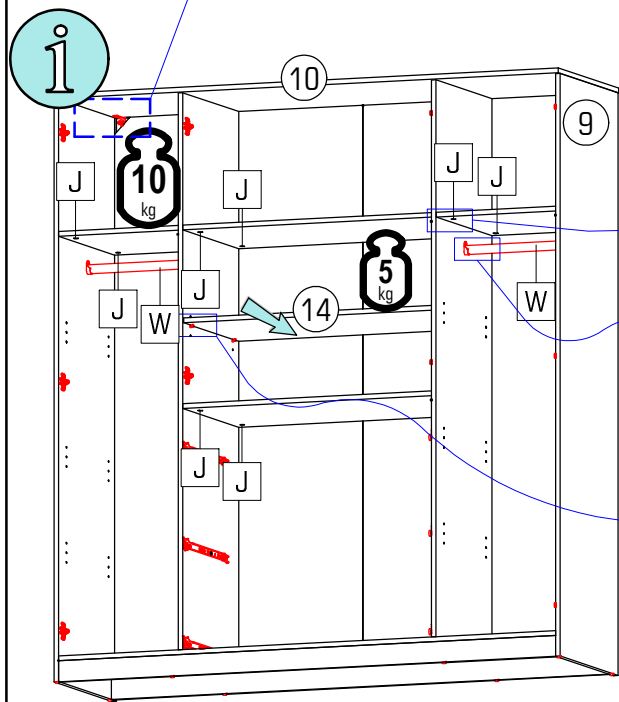

HU Vigyázat! Szerelés előtt a falfelületet feltétlenül vizsgálja meg. A mellékelt univerzális tiplik kizárólag stabil falazathoz használható mint például beton/tégla. A fali tiplik nem használható könnyű építőkövekhez, üreg tégla, gipszkarton lapokhoz vagy más favázathoz építményekhez. Ezekhez a falfelületekhez csak speciális tiplik használhatóak, melyek szaküzletekben (barkácsáruházakban) beszerezhetőek. Fentiek figyelmen kívül hagyása esetén a gyártó/kereskedő vagy forgalmazó nem vállal felelősséget.

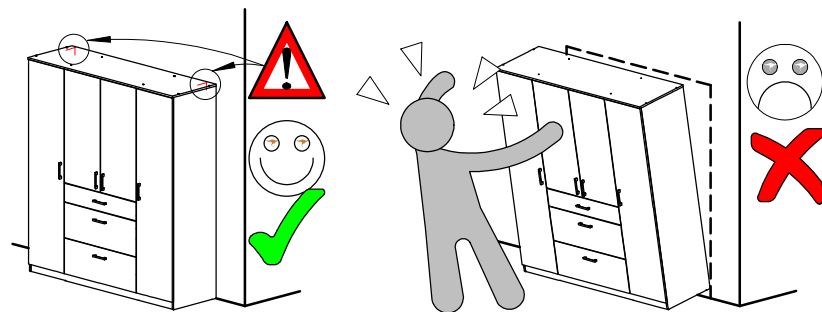
SK Upozornenie! Pevnosť steny sa musí pred montážou bezpodmienečne skontrolovať. Priložené univerzálne hmoždenky používajte jedine pre pevné murovo ako je betón/tehla. Hmoždenky sa nesmú používať v prípade ľahkého stavebného muriva, dutá tehla, Sádrokartónová doska, alebo iných konštrukcií rámu. U týchto stien je nutné použiť špeciálne hmoždenky! Tieto je možné dostať v špeciálnych predajniach so stavebným materiálom. Pri nedodržaní pokynov nepreberajú výrobcovia/predajci a dodávateľia zodpovednosť za vzniknuté škody.



SK	VÝSTRAHA
CZ	VAROVÁNÍ
HR	UPOZORENIE
DE	WARNUNG
HU	FIGYELEM
PL	OSTRZEŻENIE
RO	AVERTIZARE
EN	WARNING
SI	OPOZORILO

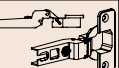

					
A	3x	C1	8x	C2	4x
				D	20x
				R	4x
				X	6x

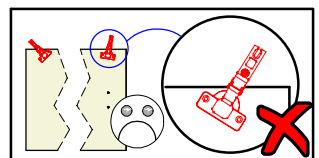
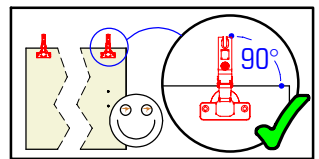
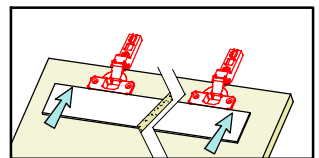
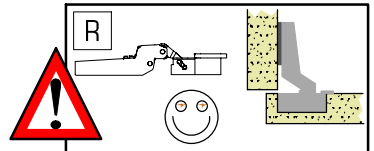
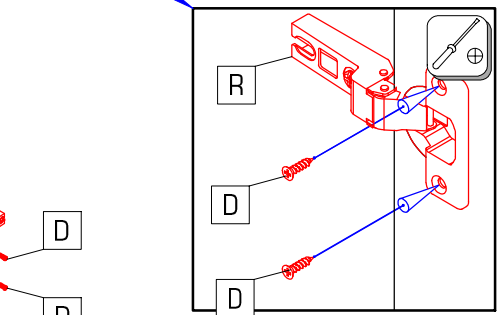
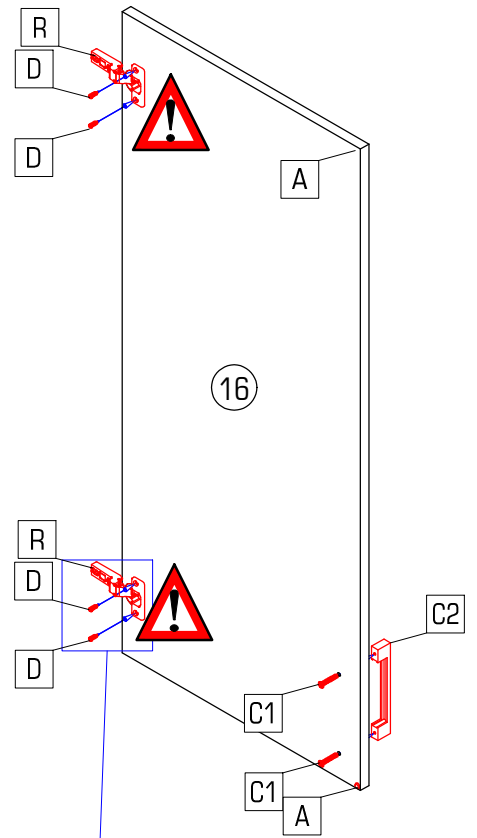
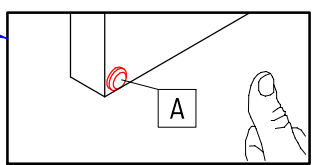
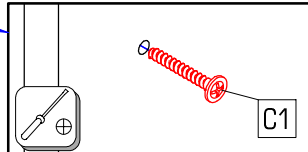
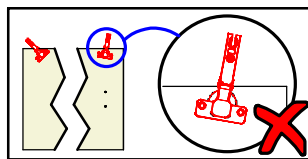
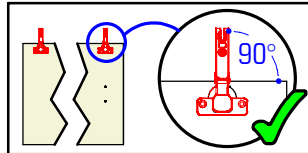
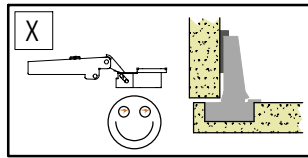
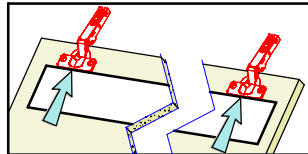
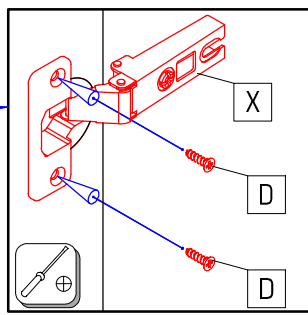
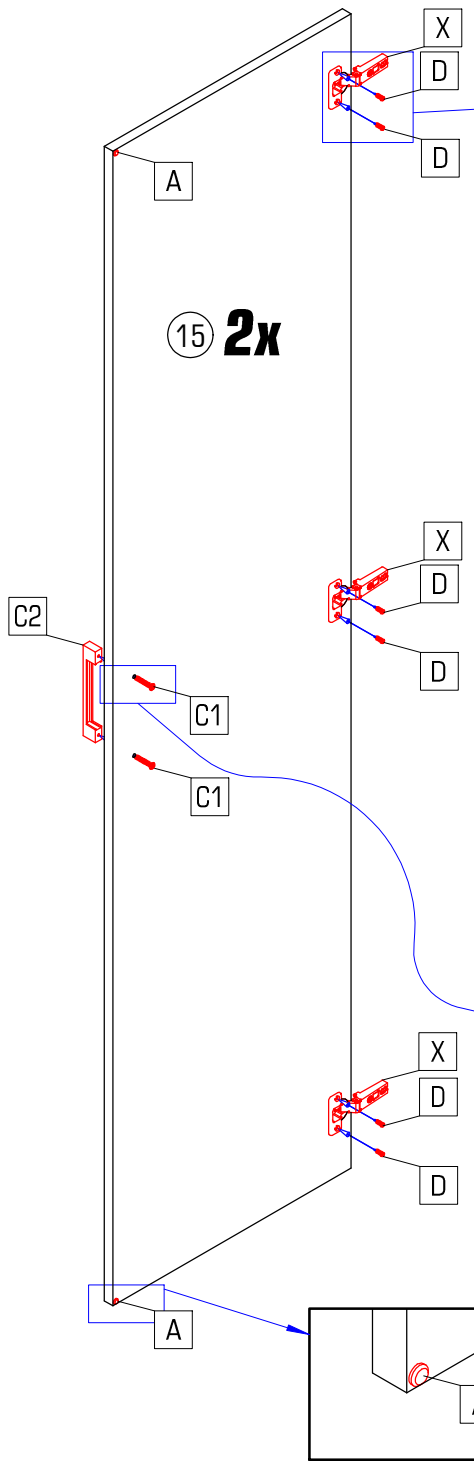



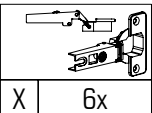

X 6x

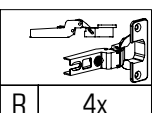

R 4x

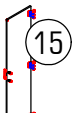



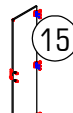

15

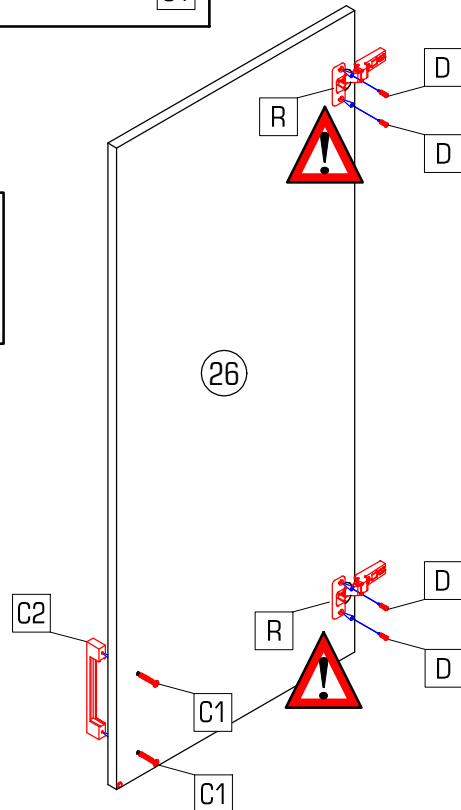

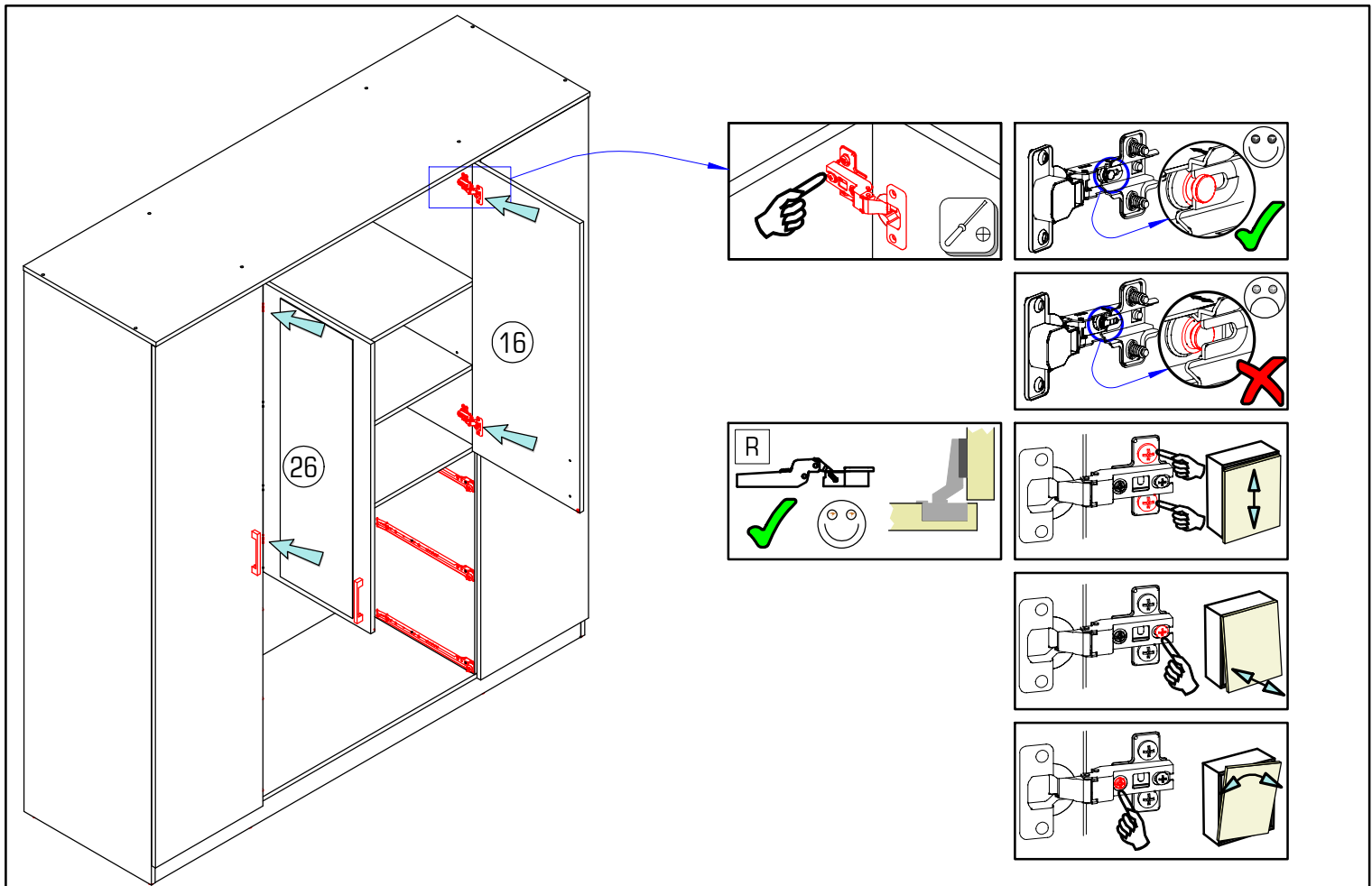
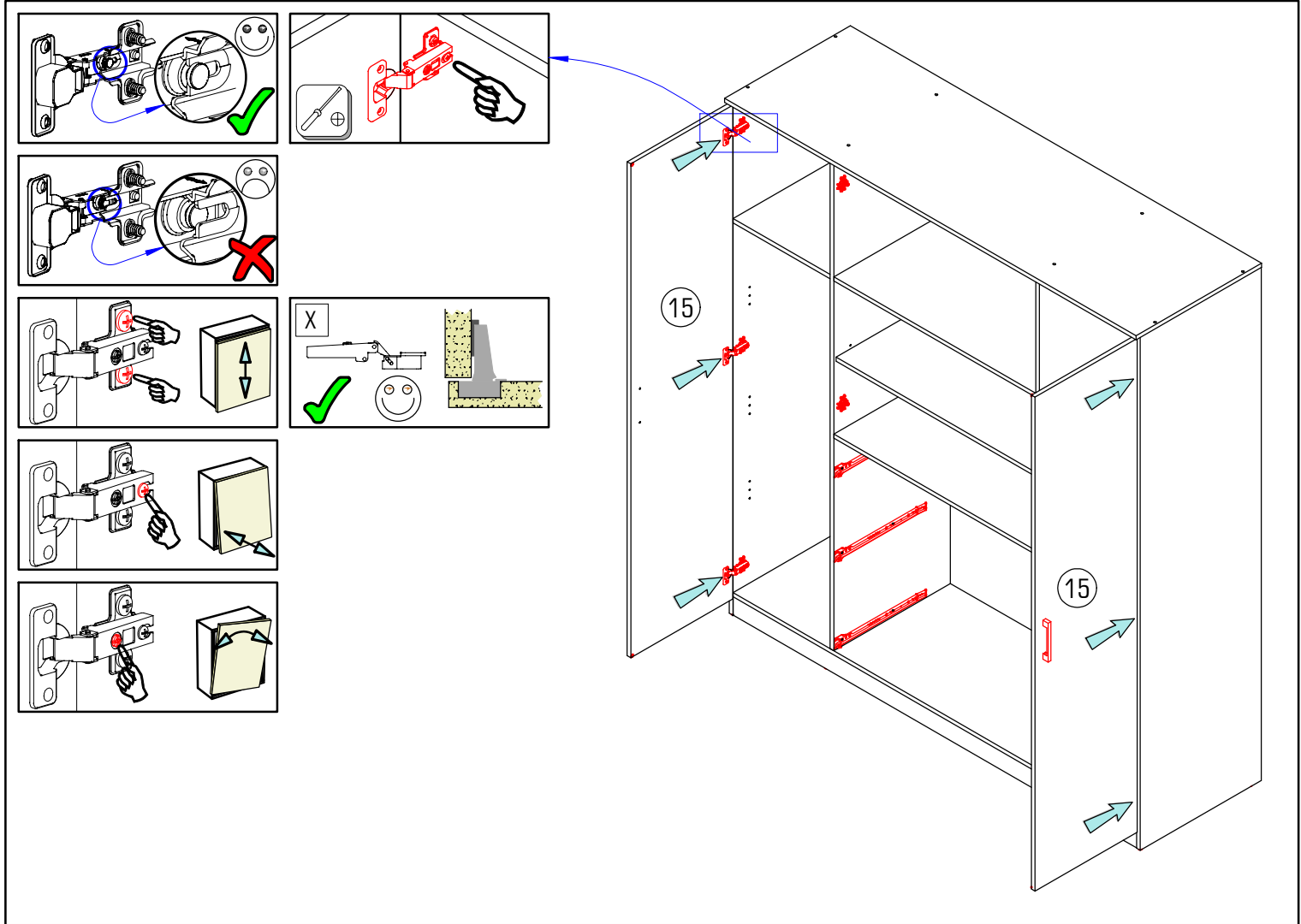



16

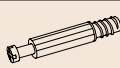

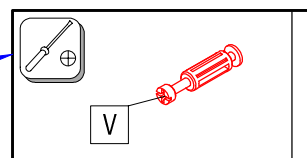
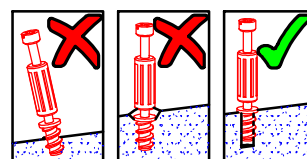
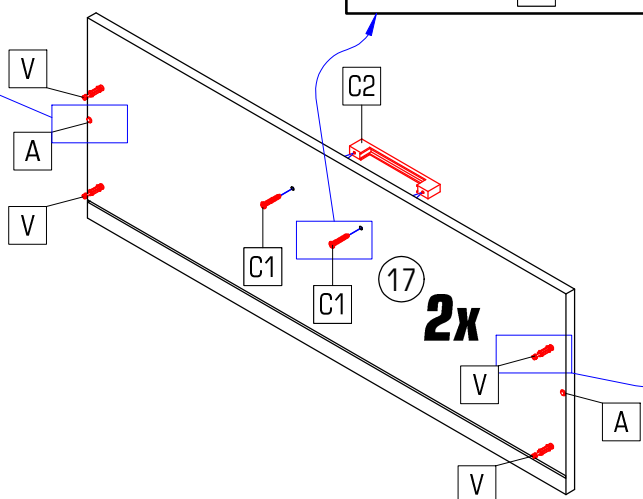
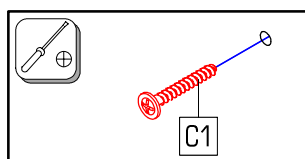
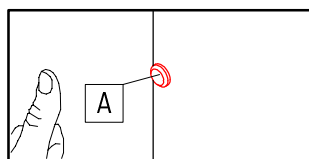
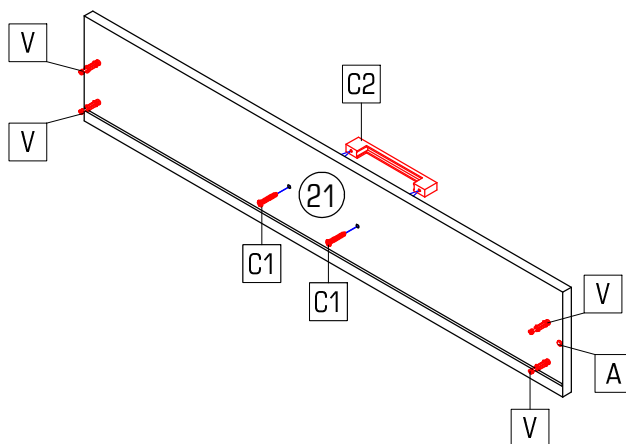
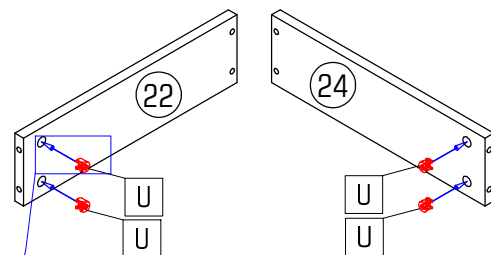
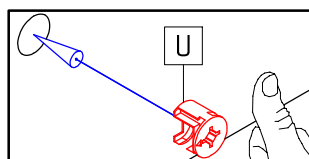
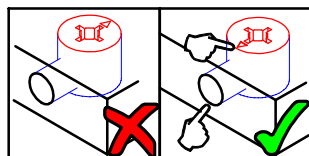
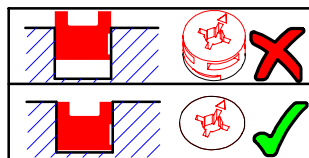
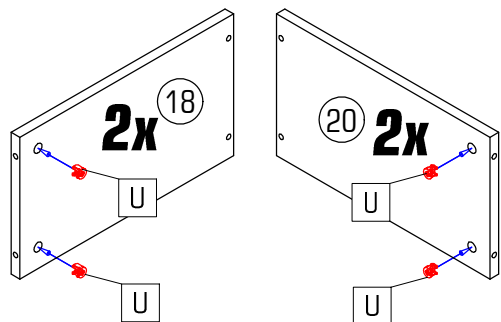
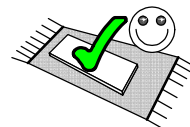
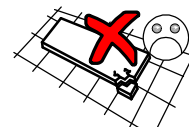



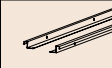

				
Ø8	Ø4x30	L=146	Ø15x13	
A 3x	C1 6x	C2 3x	U 12x	V 12x

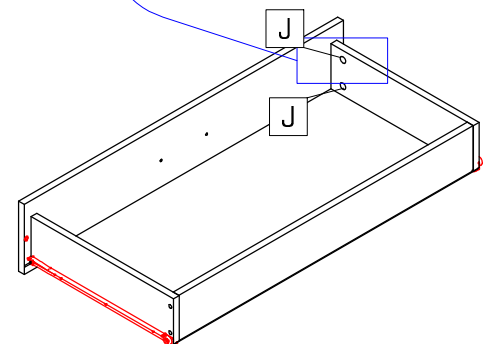
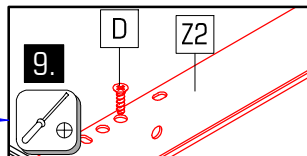
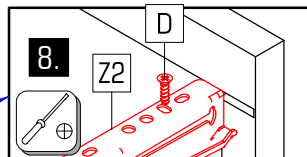
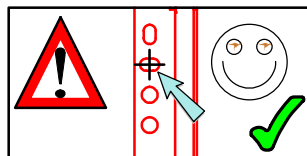
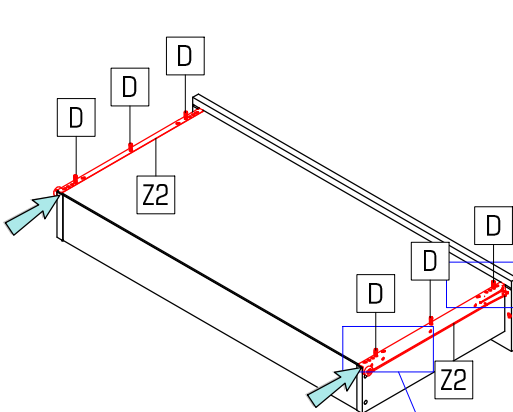
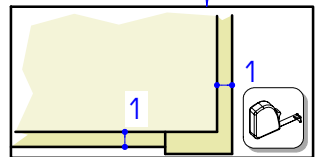
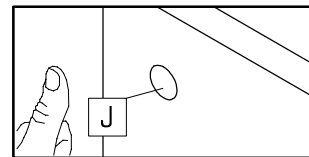
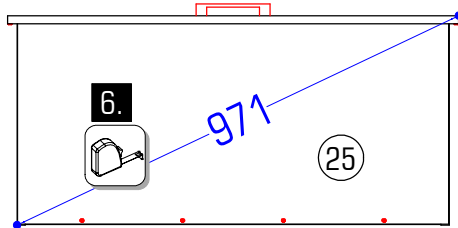
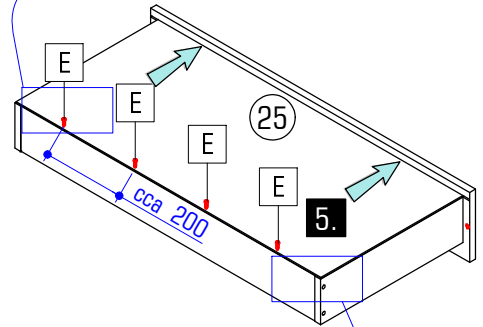
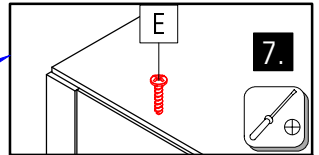
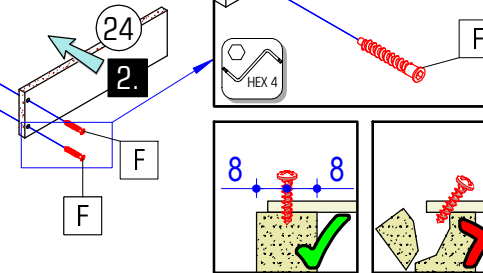
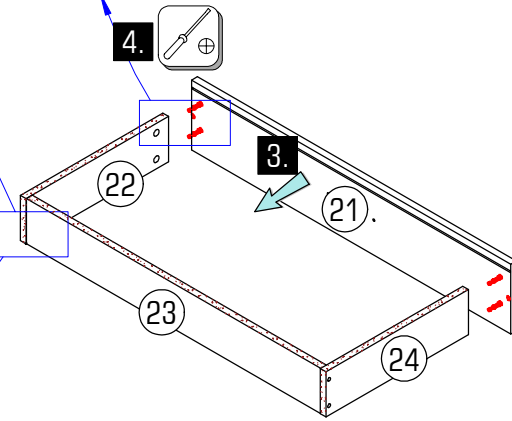
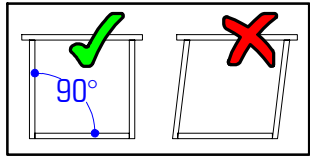
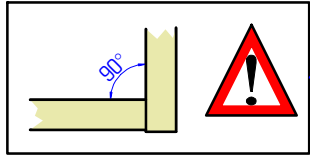
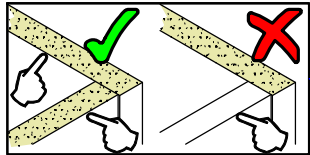
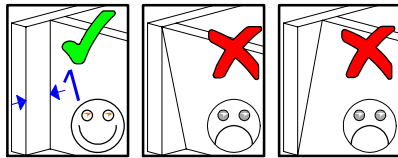
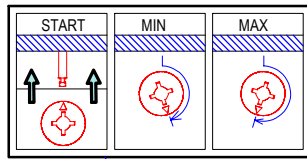
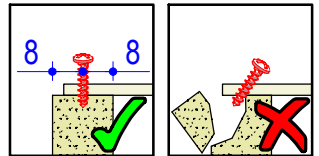
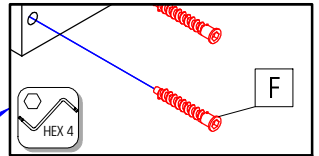
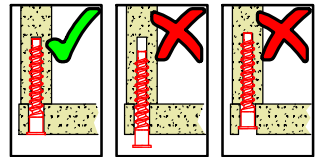
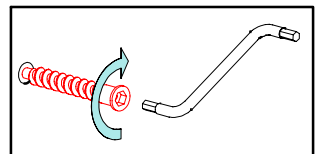
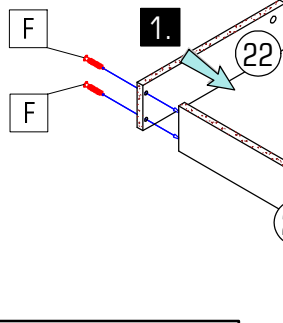
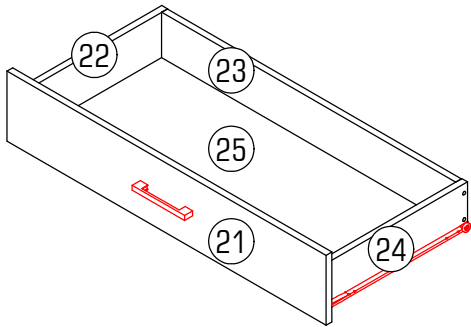

					400
D	6x	E	4x	F	4x
				J	4x
				Z2	1x

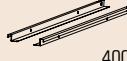

				
Ø3,5x15	Ø3,5x16	Ø7x50		400
D 12x	E 8x	F 8x	J 8x	Z2 2x

