

GREMIO

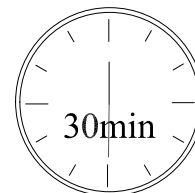

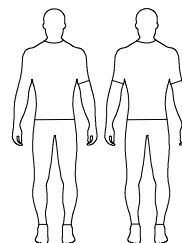

Teil	L	W	H	Pcs	Colli
1	179	103	72	1x	1/3
2	204	101	72	1x	2/3

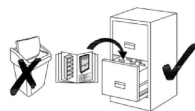
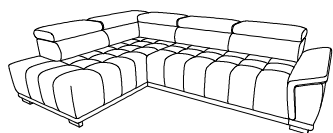
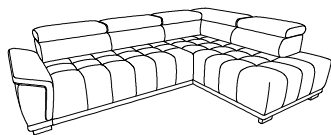
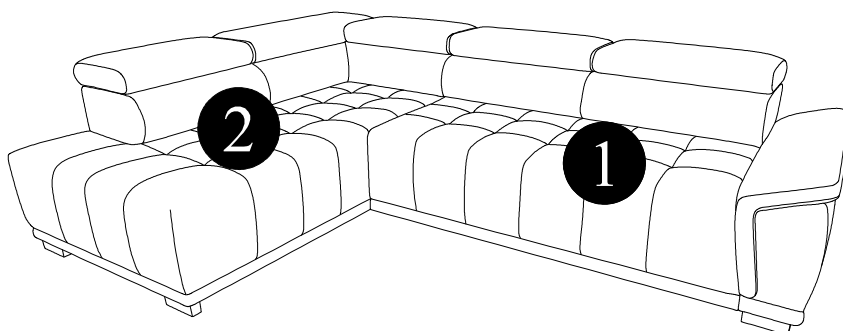

L

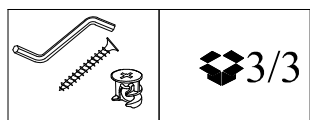
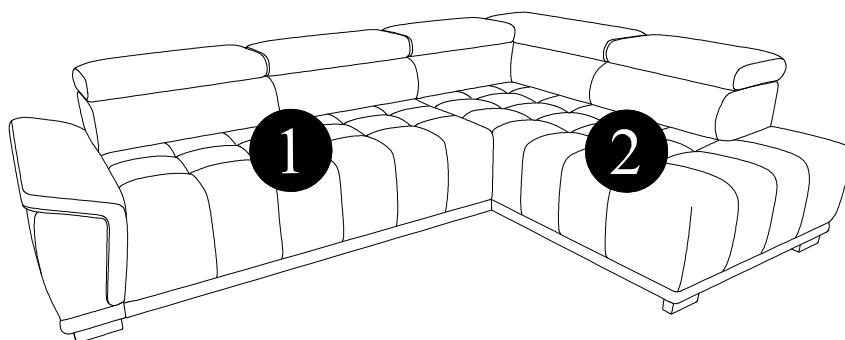

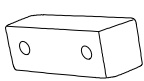
R

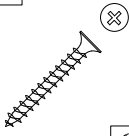
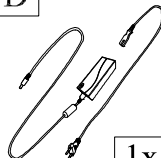

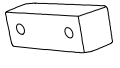

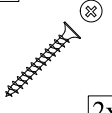
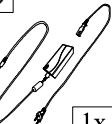
<p>A</p>  <p>3x</p>	<p>B</p>  <p>7x</p>	<p>C</p>  <p>6x</p>	<p>D</p>  <p>1x</p>
H-50 L-150	H-50	3,5x45	

A 	B 	C 	D 
1x	5x	2x	1x
H-50 L-150	H-50	3,5x45	

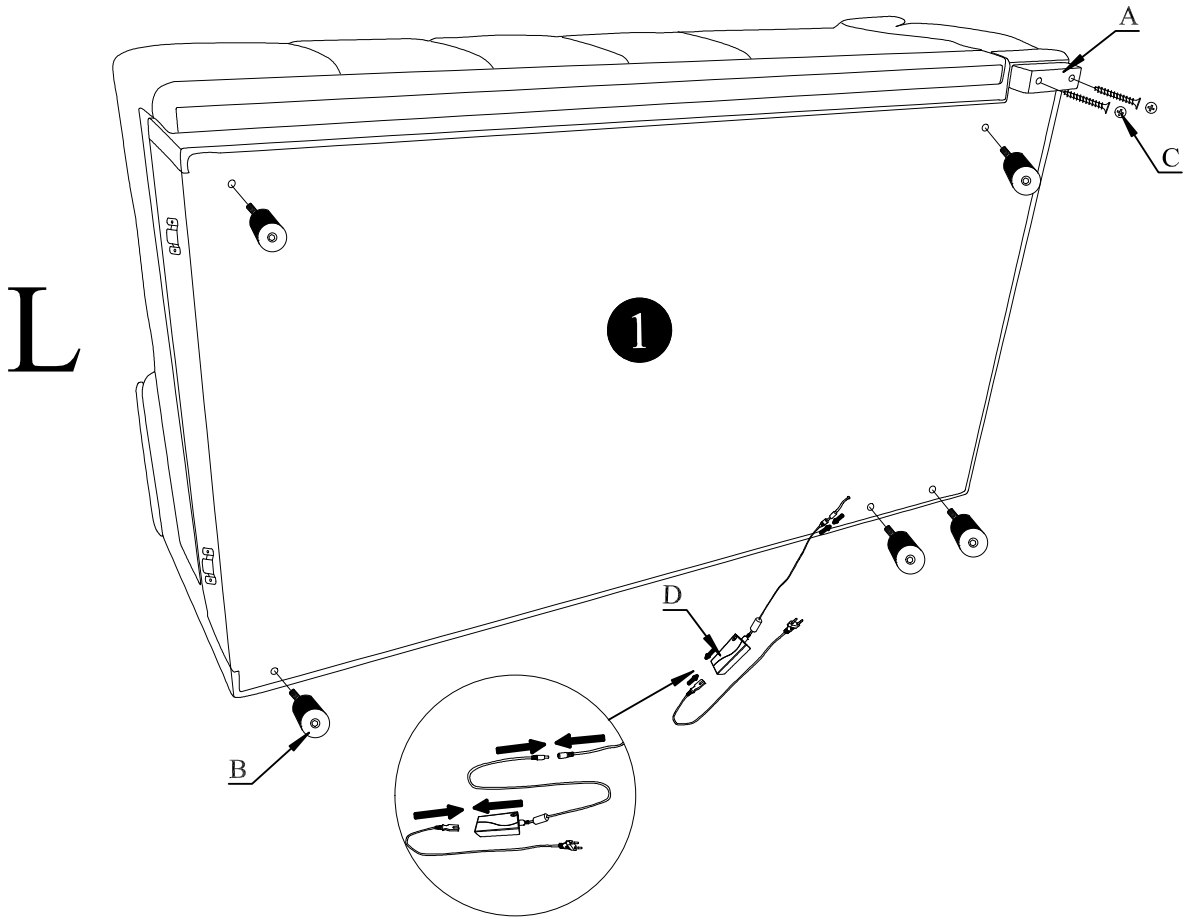
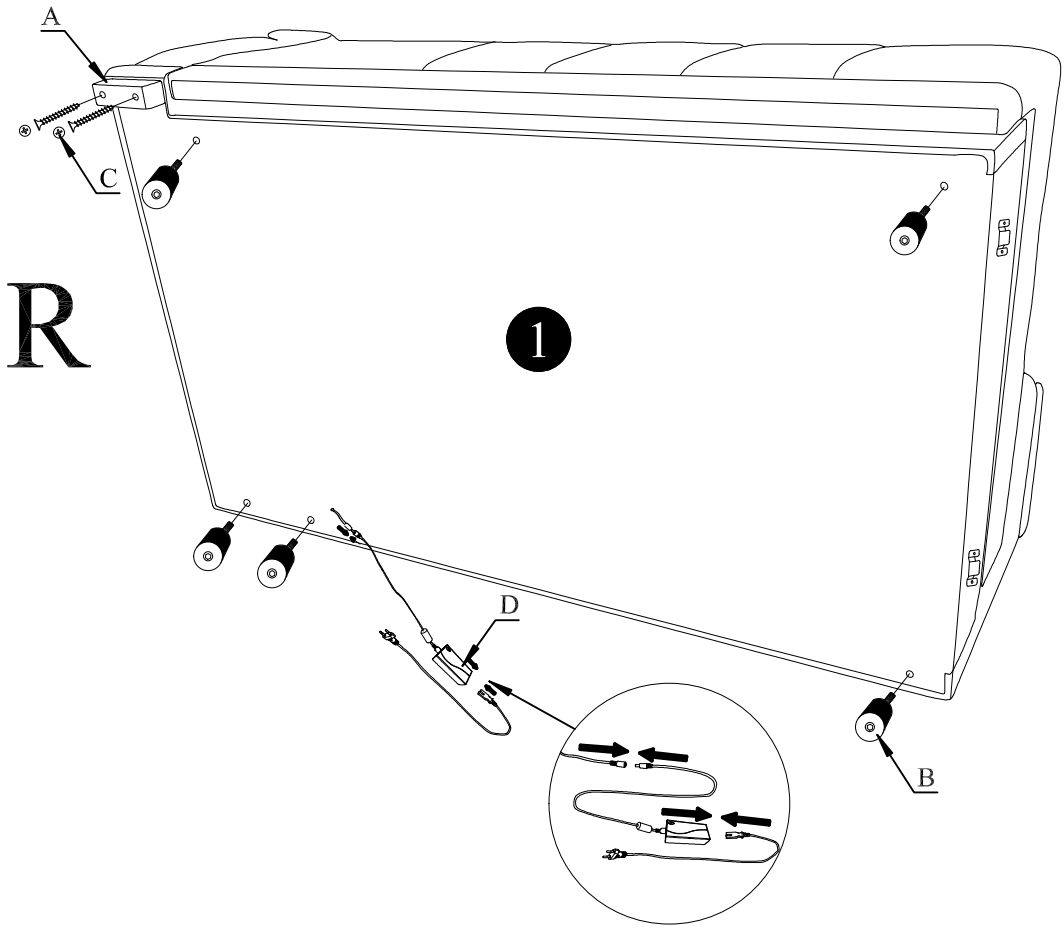
1

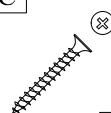

<p>A</p> 	<p>B</p> 	<p>C</p> 
<p>2x</p>	<p>2x</p>	<p>4x</p>
<p>H-50 L-150</p>	<p>H-50</p>	<p>3,5x45</p>

2

R

L

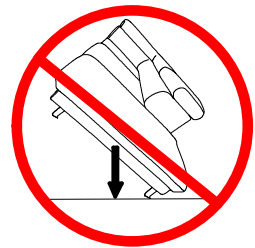
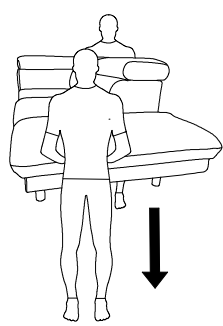
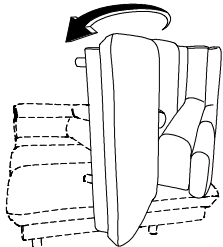
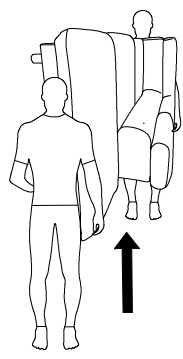
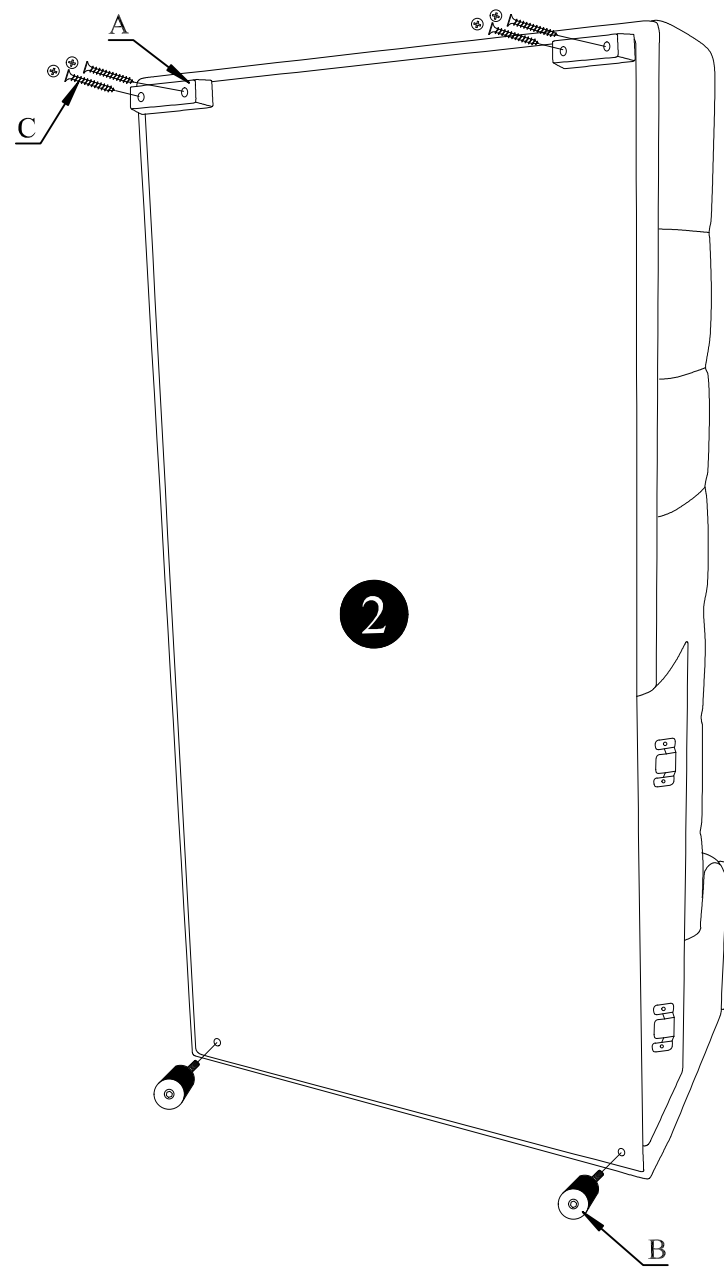
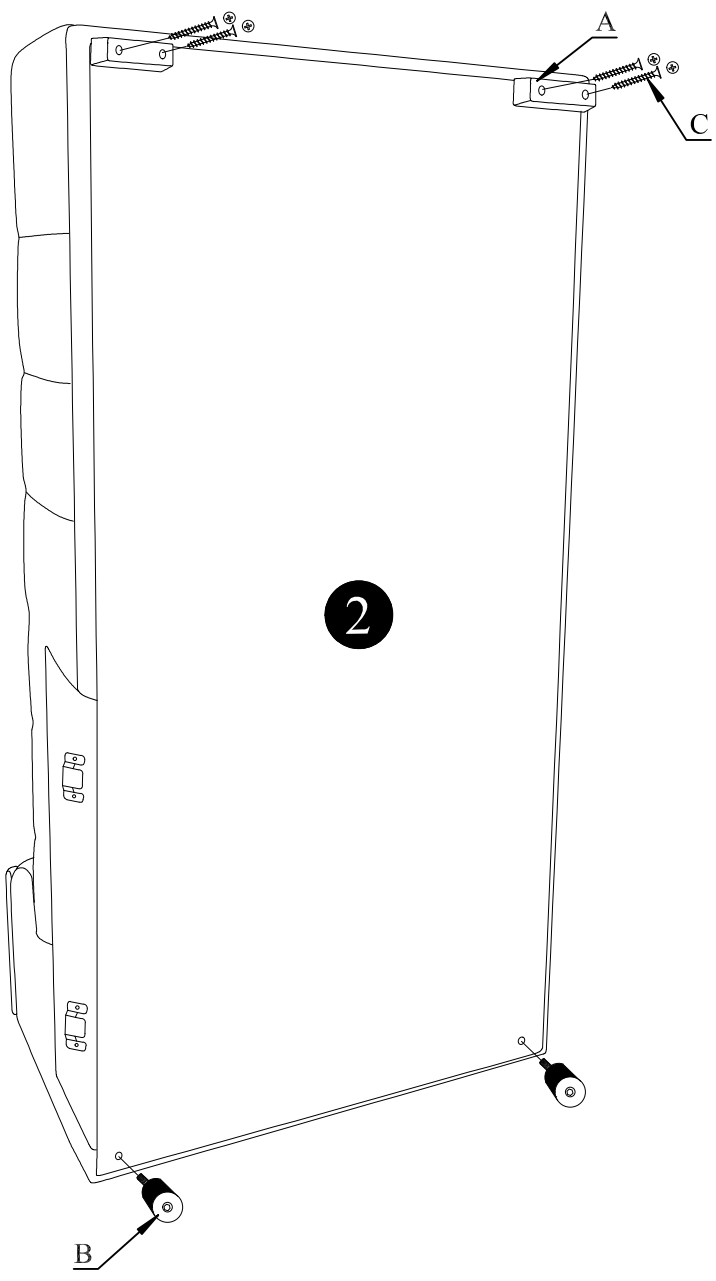

3

