

	
①	x1	②	x4	③	x2	④	x2
							
D6x30mm		D6x12mm		D5x14mm			
A	x20	B	x4	C	x1	D	x1
							
D4x35mm		D4x12mm		Ø6x30mm			
E	x2	F	x2	G	x2	H	x2
							
M4							
I	x1						

05

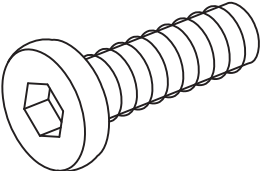

06

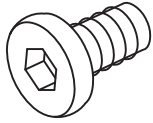
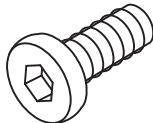
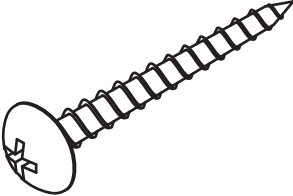
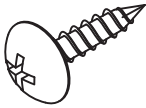
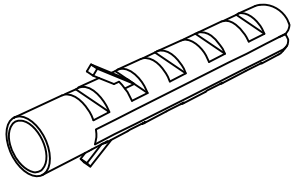
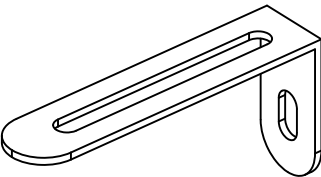
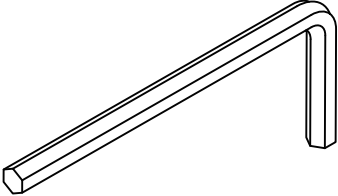
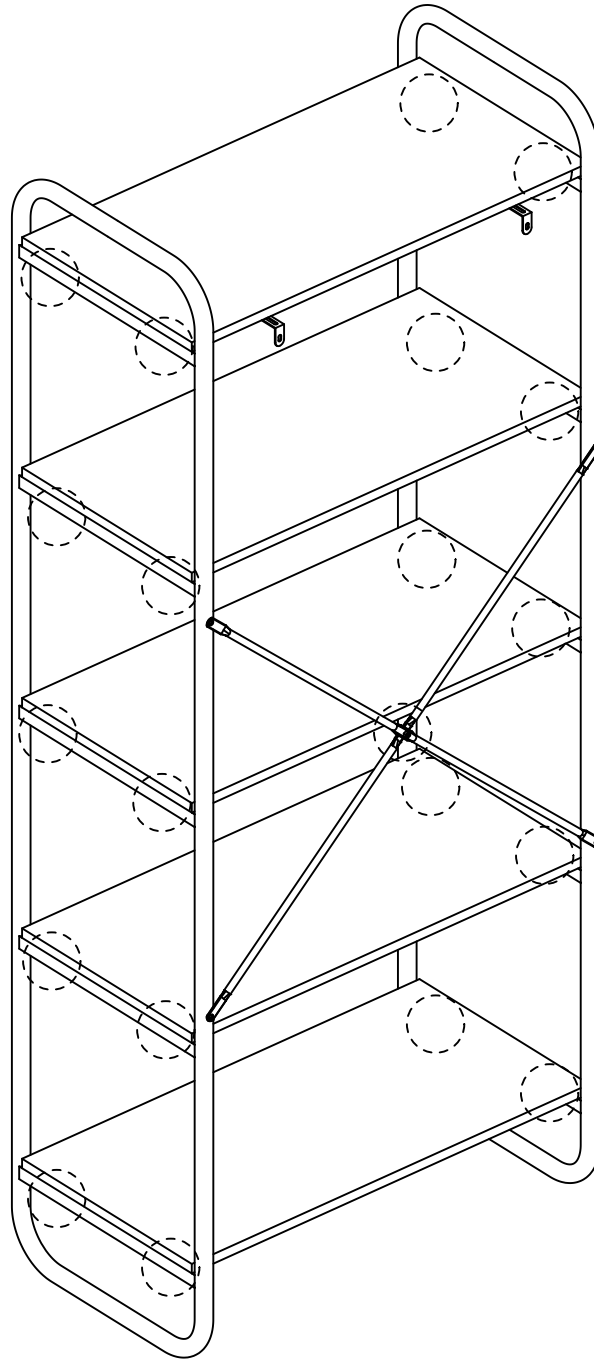
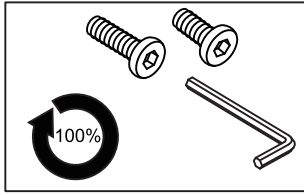